Structural and Functional Evolution of Glucose Transporter 4 (GLUT4): A Look at GLUT4 in Fish

Rubén Marín-Juez, Encarnación Capilla,
Francisco Carvalho-Simoes, Marta Camps and
Josep V. Planas

Additional information is available at the end of the chapter

<http://dx.doi.org/10.5772/58094>

1. Introduction

The insulin-responsive glucose transporter GLUT4 was first described in 1988 as a result of studies on the regulation of glucose metabolism by insulin [1]. Soon after the discovery of GLUT4, several groups cloned GLUT4 in the human [2], rat [3,4] and mouse [5]. Since its discovery, GLUT4 has received, together with GLUT1, more experimental attention than any other single membrane transport protein. Structurally, GLUT4 follows the predicted model for class I glucose transporters. GLUT4 has a high affinity for glucose, with a K_m of approximately 5 mM [6], and also transports mannose, galactose, dehydroascorbic acid and glucosamine [7-10]. In mammals, GLUT4 is mainly expressed in cardiac and skeletal muscle, brown and white adipose tissue, and brain [6,11,12]. GLUT4 plays a pivotal role in whole body glucose homeostasis, mediating the uptake of glucose regulated by insulin [13,14]. GLUT4 is responsible for the reduction in the postprandial rise in plasma glucose levels [6]. Insulin acts by stimulating the translocation of specific GLUT4-containing vesicles from intracellular stores to the plasma membrane (PM) resulting in an immediate increase in glucose transport [6,15]. The disruption of GLUT4 expression has been extensively associated with pathologies of impaired glucose uptake and insulin resistance such as type 2 diabetes and obesity [13,16-18].

Glucose is a central molecule for the metabolism of all vertebrates and plays a pivotal role as fuel and metabolic substrate [19]. From an evolutionary perspective, the regulation of glucose metabolism in non-mammalian vertebrates appears to be slightly different than in

mammals, particularly with respect to their tolerance of hyperglycemia (reviewed in [20]). A large body of research has been devoted to the study of glucose metabolism in fish species, mostly due to their phylogenetic position and their economic interest (i.e. fisheries and aquaculture). As a result of their lower ability to return to normoglycemia after feeding or after a glucose load, when compared to mammals, fish have been considered to be “glucose intolerant” [21]. This conclusion was based on the demonstrated lower ability of fish peripheral tissues (e.g. mostly the skeletal muscle, representing more than 50% of the body weight) to utilize glucose [22]. However, despite the low glucose uptake in the fish skeletal muscle, when compared to mammals, there was evidence indicating that skeletal muscle represents not only the main site of glucose uptake but that it was the only tissue in which the rate of glucose uptake was increased after a glucose load [23], suggesting that glucose uptake in skeletal muscle could be regulated. Given that insulin had been shown to lower blood glucose levels in fish by, at least in part, stimulating the *in vivo* uptake and utilization of glucose mostly by the skeletal muscle [24] and given that the blood levels of insulin were shown to be increased by administration of a glucose load in trout [23], it was hypothesized that insulin may exert its hypoglycemic effects in fish through the regulation of glucose transporters, possibly GLUT4. Initially it was claimed that GLUT4 did not exist in fish based on the inability of antibodies against mammalian GLUT4 to recognize a putative fish GLUT4 protein [25]. However, the identification of a true GLUT4 homolog in fish in 2000 by molecular cloning [26] paved the way for investigating the possible regulation of glucose homeostasis in fish through the regulation of an insulin-regulatable glucose transporter homologous to GLUT4. Here, we review the accumulated evidence to date on the functional characteristics and regulation of the GLUT4 homolog in fish.

2. Evolution of the structural characteristics of the GLUT4 gene

Among the sequenced genomes of vertebrate species, the GLUT4 gene (named SLC2A4) is found in mammals (41 species), reptiles (2 species) and ray-finned fishes (10 species) (Figure 1), suggesting that the GLUT4 gene has been conserved throughout evolution. Surprisingly, the GLUT4 gene is absent among birds and amphibians. The lack of GLUT4 in birds, but the presence of other GLUT family members (Glut1, Glut2 and Glut3), has recently been confirmed experimentally [27]. Moreover, no GLUT4 gene is present in the only amphibian genome available to date (i.e. *Xenopus tropicalis*) and searches for GLUT4 in *Xenopus* EST databases were unable to yield any transcript with homology for GLUT4. At this time, it is not known if the lack of the GLUT4 gene is general of the avian and amphibian classes, particularly since only a very reduced number of species have been examined, and, more importantly, if these two groups of vertebrates have subsequently lost the GLUT4 gene after their emergence.

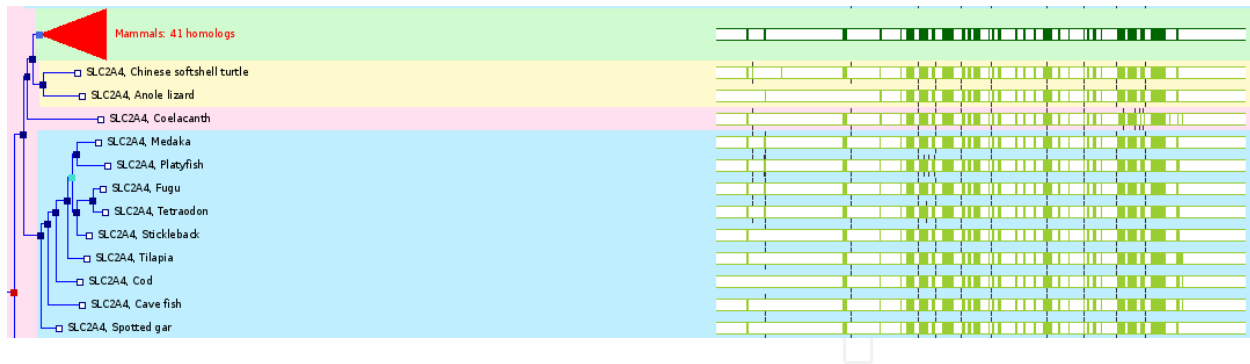

Figure 1. Evolutionary tree of the GLUT4 gene (SLC2A4) in vertebrates. Alignment of the different GLUT4 gene sequences is shown on the right. White sections of the alignment indicate gaps in the sequence.

2.1. Structural characteristics of the GLUT4 gene in fish

Fish, after mammals, are the vertebrate group for which more genomic information is available mainly due to their importance as research model species (e.g. medaka, zebrafish, stickleback) and for their economic importance in fisheries and aquaculture (e.g. cod, tilapia). Therefore, fish are only second to mammals in the number of species for which there is genomic information corresponding to the GLUT4 gene. In mammals, the GLUT4 gene is located in chromosome 17 and consists of 11 coding exons, spanning 6.6 kb. Despite the fact that the fish GLUT4 protein is well conserved among the different fish species (see section 3), certain structural differences among the fish GLUT4 genes can be observed. For example, the number of exons coding for GLUT4 and the length of the GLUT4 gene varies among the different species: 12 exons in Fugu, 13 in Tetraodon, 13 in Tilapia, 11 in Stickleback, 12 in Medaka and 15 in Platyfish, spanning 4.8 kb, 4.5 kb, 10.2 kb, 4.9 kb, 12.7 kb and 14.1 kb, respectively (Figure 2). Moreover, it is worth mentioning that exons 6 to 10 of the human GLUT4 gene appear to be highly conserved in fish (Figure 2). The only fish species with a sequenced genome for which the GLUT4 gene appears to be absent is the zebrafish. The lack of a GLUT4 gene in the zebrafish genome sequence database (Ensembl) is related to the lack of transcripts for GLUT4 in zebrafish EST databases. These observations support the notion that zebrafish may have lost the GLUT4 gene.

In addition to the gene structure characteristics of GLUT4 in fish, another aspect of interest with regards to the evolution of GLUT4 is whether the genes flanking the GLUT4 loci in the genome of the various fish species have also been conserved. A synthetic analysis of the GLUT4 loci in different fish species evidences that a number of the genes flanking the fish GLUT4 genes are homologs to those flanking the human GLUT4 gene (e.g. YBX2, EIF5AL1, GPS2, GABARAP, CTDNEP1, NEURL4, TNK1, PLSR3) (Figure 3A). Furthermore, the nature and the genomic position of the genes flanking the GLUT4 gene in fish are highly conserved across the different fish species (Figure 3B).

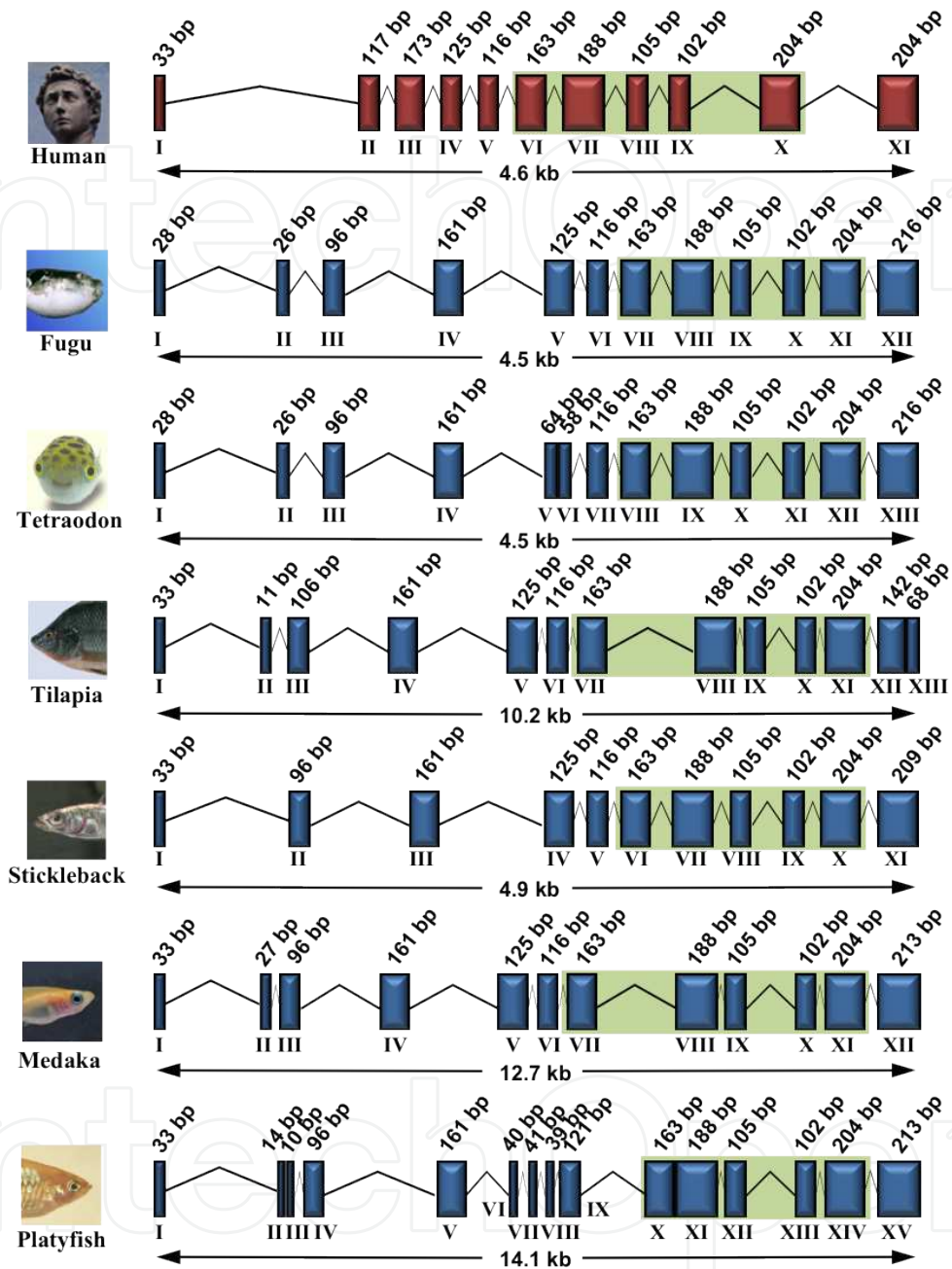

Figure 2. Genomic structure and organization of GLUT4 in fish. Exons are represented by solid boxes and introns are represented by connecting lines. The sizes of exons are shown in base pairs on the top of the boxes. Exons are numbered with roman numbers beneath the boxes. Exons conserved in all the species are highlighted in green. Gene IDs were retrieved from public databases-Human: ENSG00000181856; Fugu: ENSTRUG00000011935; Tetraodon: ENSTNIG00000010138; Tilapia: ENSONIG00000018958; Stickleback: ENSGACG00000019384; Medaka: ENSORLG00000006341; Platyfish: ENSXMAG00000015723.

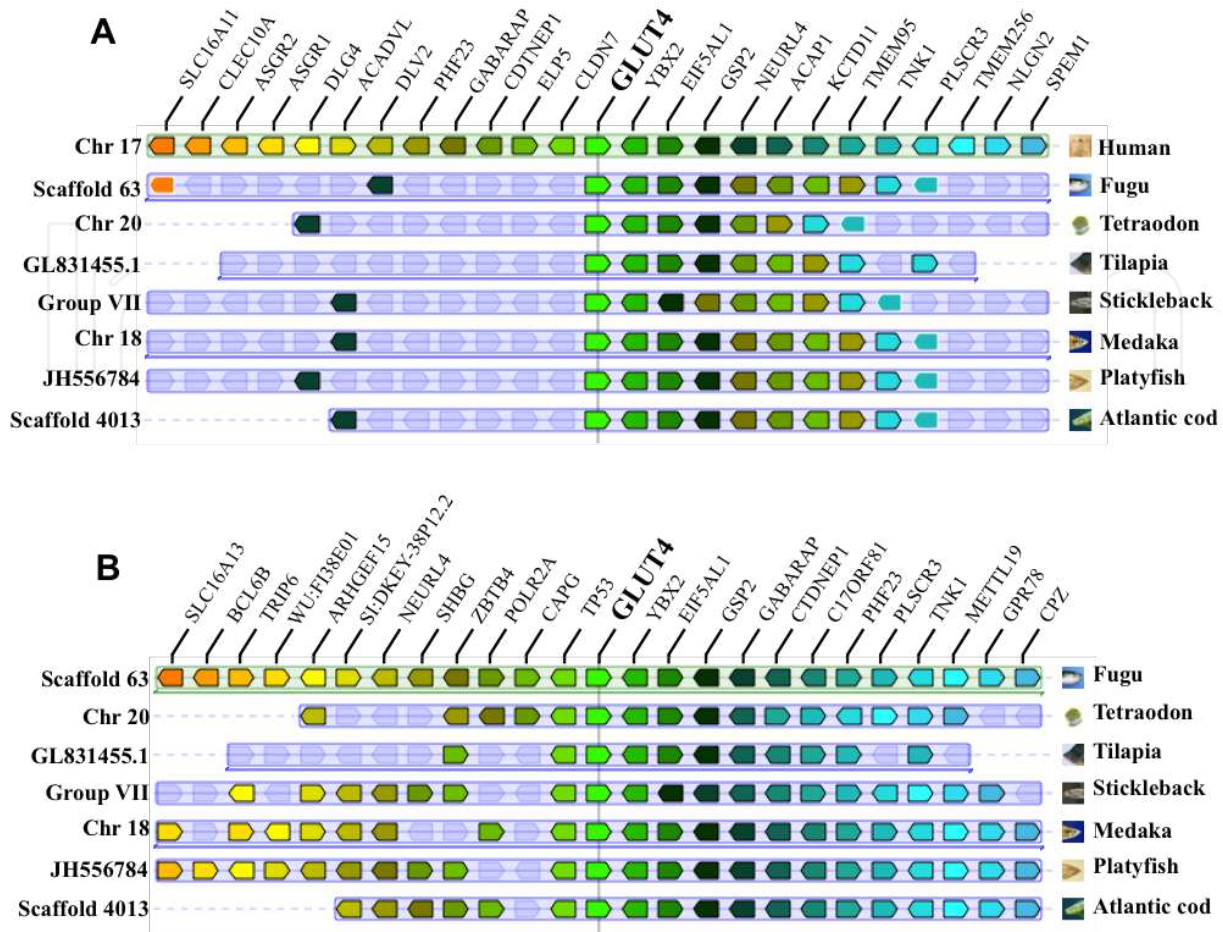

Figure 3. Comparison of genomic regions carrying GLUT4 loci. A. Synteny in relation to the human GLUT4 gene. B. Synteny of fish GLUT4 genes in relation to the Fugu GLUT4 gene. Boxes of the same color indicate the position of the ortholog in the different species. The coding direction of the genes is indicated by the pointed end. Pale blue symbols indicate nonsyntenic genes. Location in the Genome of each species is indicated at the left side of the diagram. Gene IDs were retrieved from public databases-Human: ENSG00000181856; Fugu: ENSTRUG00000011935; Tetraodon: ENSTNIG00000010138; Tilapia: ENSONIG00000018958; Stickleback: ENSGACG00000019384; Medaka: ENSORLG00000006341; Platyfish: ENSXMAG00000015723; Atlantic cod: ENSGMOG00000007757. The diagram was generated using Genomicus genome browser [28].

As is known in mammals, the GLUT4 gene undergoes an important regulation at the transcriptional level that takes place in the upstream regulatory regions of the gene (i.e. promoter region) [29]. Recently, the promoter region of the GLUT4 gene in a fish species (i.e. Fugu) was characterized for the first time [30]. A 1.3 kb 5'-flanking region of the Fugu GLUT4 gene was characterized with 3 possible transcription start sites, a conserved cluster of CpG dinucleoties (i.e. CpG island) and several transcription factor binding sites known to be important for the transcriptional regulation of the mammalian GLUT4 gene such as MEF2, SREBP, KLF, SP1/GC-box, NF-Y, E-box, PPAR γ , PPAR-RXR and HIF-1 (Figure 4) [30]. In addition, like in mammals, the Fugu GLUT4 gene promoter lacks TATA-box elements [30]. *In silico* comparison of the 1.3 kb genomic DNA region upstream of the GLUT4 gene in different fish species revealed the presence of two highly conserved regions containing most of the above cited binding motifs (Figure 4). Interestingly, these two regions contain the E-box/MEF2/Klf cassette,

which is an important cassette placed in an enhancer region of the promoter of the GLUT4 gene in mammals [29], and the core promoter, essential for the basal expression of the GLUT4 gene. These observations highlight the high degree of conservation of the GLUT4 gene and its regulatory region during evolution from fish to mammals.

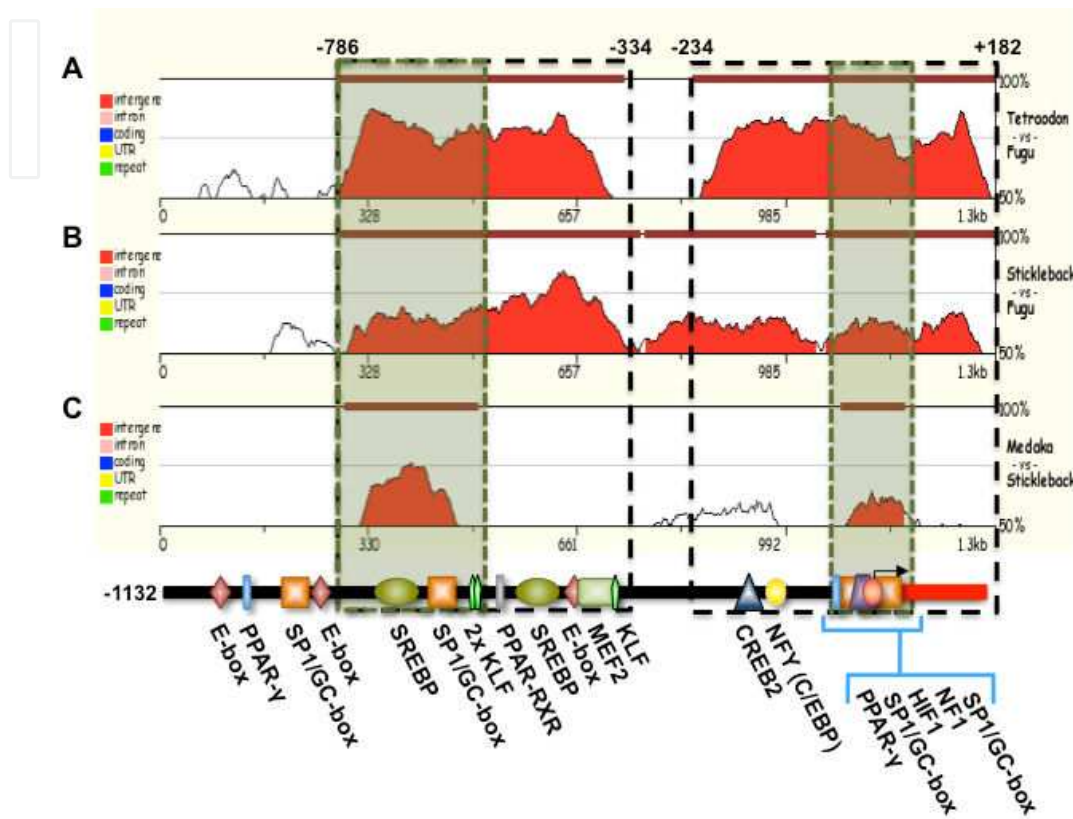

Figure 4. Conservation profile of the promoter region of known fish GLUT4 genes. Sequence elements of significant length (≥ 100 nucleotides) that show higher than 60% of homology are highlighted in red and depicted with the dark-red rectangles on the top of each graph. The sequence comparison between the Fugu and Tetraodon (A), Fugu and Stickleback (B) and Stickleback and Medaka (C) GLUT4 promoters is shown. The horizontal axis represents the position of the nucleotides within the 1314 bp sequence compared, starting at the 5' end. The vertical axis represents the percent of identity between the aligned genomes. In the bottom, a schematic representation of the -1132 Fugu GLUT4 gene promoter highlighting the most relevant predicted binding sites is shown. The open boxes delineating the regions comprised between -786/-334 and -234/+182 nucleotides represent conserved areas in fish GLUT4 gene promoters. Adapted from [30].

3. Structural characteristics of the GLUT4 protein in fish

In fish, the deduced amino acid sequence of GLUT4 is known in approximately 10 different species as a result of either conventional cloning techniques or available sequences in databases. Similar to mammalian GLUT4, a protein of 509 amino acids in length, known fish GLUT4 proteins range between 503 and 511 amino acids in length. Also like mammalian GLUT4, fish GLUT4 proteins have a predicted molecular mass of approximately 55 kDa and an isoelectric

point of 6.7. Western blotting using polyclonal antibodies against coho salmon GLUT4 (okGLUT4) confirmed that the molecular weight of native GLUT4 in adipose tissue and skeletal muscle cells from salmonid species was approximately 50 kDa [31,32]. Comparison of human GLUT4 and fish GLUT4 proteins evidences a relatively high degree of conservation at the amino acid level, with fish GLUT4 proteins showing a 79% sequence homology to human GLUT4. However, fish GLUT4 proteins show more than 90% homology amongst themselves at the amino acid level, even when considering species that are phylogenetically distant such as coho salmon and tilapia. Phylogenetic analyses of fish GLUT4 proteins in relation to human GLUT4 reveal that all fish GLUT4 proteins are evolutionarily related to human GLUT4 and that they cluster according to their phylogenetic position within the fish evolutionary tree (Figure 5).

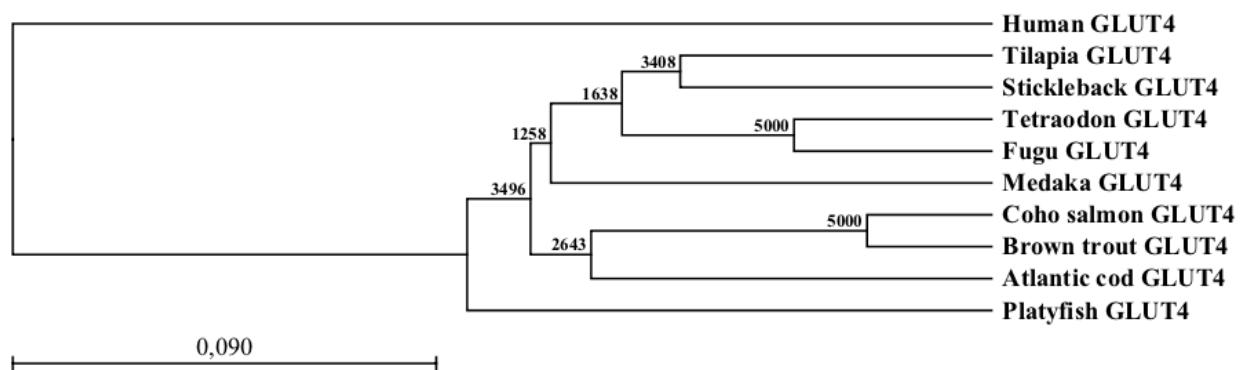

Figure 5. Unrooted phylogenetic tree of GLUT4 amino acid sequences. The tree was created by the UPGMA method using ClustalW multiple alignment and bootstrapped 5000 times. The scale for the given branch length indicates 0.09 amino acid substitutions per site. Gene IDs and accession numbers were retrieved from public databases-Human: ENSG00000181856; Fugu: ENSTRUG00000011935; Tetraodon: ENSTNIG00000010138; Tilapia: ENSO-NIG00000018958; Stickleback: ENSGACG00000019384; Medaka: ENSORLG00000006341; Platyfish: ENSX-MAG00000015723; Atlantic cod: AAZ15731.1; Brown trout: AAG12191.1; Coho Salmon: AAM22227.1.

Importantly, the structural characteristics of all the known fish GLUT4 proteins correspond to those of the facilitated glucose transporter family and, specifically, to those of mammalian GLUT4. The structural conservation of GLUT4 from fish to mammals can clearly be observed when an alignment of the deduced amino acid sequence of fish GLUT4 proteins with human GLUT4 is performed (Figure 6). Like human GLUT4, all fish GLUT4 proteins contain the typical 12 (I-XII) hydrophobic transmembrane domains (TMs) of 21 amino acids that have also been revealed by hydropathy plots [26,31]. Furthermore, all fish GLUT4 proteins contain four major hydrophylic regions corresponding to the amino (N) terminus, the carboxy (C) terminus and the two main extracellular and intracellular domains. The main extracellular domain corresponds to a loop of approximately 30 amino acids located between TMI and TMII and contains a predicted glycosylation site (K⁵⁰) that is present in all mammalian and avian GLUT proteins. The large intracellular domain corresponds to a cytoplasmic loop of 65 amino acids located between TMVI and TMVII. Other structural characteristics of functional GLUT proteins that are found in fish GLUT4 include the presence of (1) the QLS motif in TMVII, known to be important for the high-affinity recognition of the transported substrate, (2) the

In addition to having sequence features typical of GLUTs, fish GLUT4 proteins also share certain sequence motifs that are characteristic of GLUT4 and that confer its particular intracellular traffic behavior. Specifically, the N-terminus of human GLUT4 contains the F⁵QQI⁸ motif that has been shown to be important for its internalization from the cell surface [36]. Furthermore, the C-terminus of human GLUT4 contains the acidic cluster T⁴⁹⁸ELEY⁵⁰² that has been shown to be important for the intracellular retention of GLUT4 under basal conditions [37] (see below). Mutations of either these two motifs in GLUT4 lead to alterations in the intracellular traffic of GLUT4 [37]. Importantly, fish GLUT4 proteins contain these two essential motifs, although with some differences in their sequence. For example, fish GLUT4 proteins show similarities to human GLUT4 in terms of the sequence of these two motifs. The F⁵QQI⁸ motif is present in the form of F⁵QQL⁸ in all fish species examined, except for brown trout (btGLUT4) that has a F⁵QHL⁸ motif (Figure 6). As will be discussed below, substitution of H⁷ for Q⁷ may have functional consequences for the traffic of GLUT4 among the different fish species. In addition, the T⁴⁹⁸ELEY⁵⁰² motif is present in fish GLUT4 proteins, with medaka GLUT4 having an identical motif but with small substitutions in other fish GLUT4 proteins, such as D⁵⁰¹ for E⁵⁰¹ in six species (i.e. salmon, trout, cod, platyfish, tilapia and stickleback) and such as M⁵⁰⁰ for L⁵⁰⁰ in only two species (tetraodon and tilapia). The C-terminal residue Y⁵⁰², thought to be important for regulating the release of GLUT4 from its intracellular storage compartments [38], was present in five of the fish species examined (tilapia, medaka, platyfish, trout and salmon). However, despite these similarities between human and fish GLUT4 proteins, the motif L⁴⁸⁹L⁴⁹⁰ that is thought to be important for the regulation of GLUT4 translocation from cytosolic compartments to the PM and for its endocytosis [39-41], is not present in fish GLUT4 proteins. Therefore, although fish GLUT4 proteins are clearly homologous to mammalian GLUT4 and contain protein motifs important for the function, regulation and traffic of GLUT4, they show differences in the sequence of these important motifs that may account for slightly different properties. One interesting possibility is that the above-mentioned differences in the primary structure between fish and mammalian GLUT4 could cause differences in the structure/conformation of the transporter, which could affect its ability to transport glucose and/or to bind factors that interact with GLUT4 and, consequently, alter its intracellular traffic. For this reason, studies have been performed with fish GLUT4 as a natural mutant of mammalian GLUT4 to contribute to our understanding of the role of the specific domains of GLUT4 that are responsible for its traffic behavior (see Section 6).

4. Sugar transport properties of fish GLUT4

The functionality of GLUT4 in fish has been investigated for okGLUT4 using the *Xenopus laevis* oocyte system [31]. The *Xenopus* oocyte system was extensively used in the 90s to functionally characterize the different GLUT isoforms in mammals [7,8,42,43], since it presents a series of advantages with respect to other *in vitro* systems: 1) the oocyte contains all the machinery necessary to properly express heterologous proteins; 2) it has very low endogenous levels of glucose transport, which avoids interferences in the measurements; and 3) it allows to analyze separately GLUTs that *in vivo* may be present together in the same tissue. Therefore,

using this system, okGLUT4 was demonstrated to be a functional glucose transporter, with characteristics similar to those of its mammalian counterparts [31].

Regarding the kinetics of fish GLUT4, studies were performed using zero-trans and equilibrium exchange conditions with 2-deoxy-glucose (2-DG) and the non-metabolizable glucose analogue, 3-O-methylglucose (3-OMG), respectively [31]. From the zero-trans kinetic analyses, the transport of glucose by the oocyte was demonstrated to be saturable, with a K_m value on average of 7.6 mM. Using the equilibrium exchange assay and, assuming the transport follows first-order kinetics, the average K_m value calculated for 3-OMG uptake by okGLUT4-expressing oocytes was of 14.4 mM. These K_m values were higher than those reported using the same oocyte system for mammalian GLUT4s: 4.6 and 1.8-4.3 mM for zero-trans and equilibrium exchange kinetics, respectively [7,8,44], suggesting that the fish transporter has less affinity for glucose. Nevertheless, when compared with kinetics of the Glut1 isoform identified in trout (OnmyGlut1), also studied in *Xenopus* oocytes, we observed that the zero-trans K_m value of okGLUT4 was lower than that of OnmyGlut1 (8.3-14.9 mM) [45]. Moreover, the K_m value reported in American eel erythrocytes, that primarily express Glut1, was also higher (10.4 mM) than that of okGLUT4 [46]; thus, indicating that the relative affinity for glucose of fish GLUTs parallels that of mammals, since the ubiquitous Glut1 has also lower affinity for glucose (21.3-26.2 mM) than GLUT4 [7,44]. On the other hand, the lower affinity for glucose of the fish GLUTs in comparison to mammals, may explain the reduced tolerance presented by the former to dietary carbohydrates [21,22].

To further characterize the fish GLUT4 transporter, stereoselectivity and substrate specificity were also analyzed in *Xenopus* oocytes expressing okGLUT4, using different sugars as transport competitors of 2-DG [31]. okGLUT4 was demonstrated to be stereospecific as its mammalian counterparts [8,31], since all the D-monosaccharides tested (glucose, mannose and galactose), but not the corresponding L-isomers, reduced the uptake of 2-DG into the oocyte. Interestingly, okGLUT4 transported all the various D-sugars, although with different affinities, as shown by the degree of competition towards 2-DG uptake observed for each monosaccharide. In this sense, D-glucose and D-mannose were primarily transported by okGLUT4 and, to a lesser extent, D-galactose and also D-fructose, albeit with even lower affinity. Overall, these data indicate that fish GLUT4 shows lower substrate specificity than mammalian GLUT4, suggesting that they may have a broader range of functions in fish controlling glucose metabolism. In this sense, it is interesting to note that okGLUT4 is able to uptake fructose, a role that is attributed to Glut2 in mammals [8,31]. Therefore, together with the fact that fish GLUT4 has a wider tissue distribution, the transport characteristics of fish GLUT4 support the idea that GLUT4 may play a role in the postprandial absorption of dietary glucose.

Moreover, okGLUT4 transport activity was shown to be suppressed by different transport inhibitors; thus, corroborating that this fish transporter belongs to the family of facilitative GLUTs [31]. 2-DG uptake in *Xenopus* oocytes expressing okGLUT4 was dose-dependently decreased by the well-known intracellular inhibitor cytochalasin B [47-49] as well as by the extracellular inhibitor, ethylidene glucose [34]. Cytochalasin B was previously shown to inhibit glucose transport in fish erythrocytes, suggesting the existence of GLUT transporters in fish before their discovery [46,50-52], and later also in *Xenopus* oocytes expressing the OnmyGlut1

transporter [45]. Furthermore, in L6 muscle cells stably expressing btGLUT4, a dose-dependent inhibition in response to cytochalasin B was also reported [32]. In this same study, the effect of indinavir, a known GLUT4 mammalian inhibitor [53-55] was analyzed, causing also a concentration-dependent decrease on 2-DG uptake. Overall, these results confirm that okGLUT4 presents similar biochemical properties as mammalian GLUT4. In summary, all these studies have demonstrated that fish GLUT4 is a functional GLUT that is a structural and functional homolog of mammalian GLUT4 but with the important difference that has lower affinity for glucose and wider substrate specificity than mammalian GLUT4.

5. Regulation of the expression of GLUT4 in fish

As all membrane solute carriers, GLUT4 exerts its glucose transport properties when is present in the PM, allowing the flux of glucose across a concentration gradient. Therefore, the GLUT4-mediated transport of glucose can be determined, at least in great part, by the number of transporter molecules present at the PM at any given time. In mammals, the abundance of GLUT4 at the PM of skeletal muscle or adipose cells is, in turn, dependent on the traffic mechanisms that translocate pre-existing, vesicle-bound GLUT4 to the PM but, ultimately, on the synthesis of GLUT4 proteins (reviewed in [29]). The following section reviews available data on the regulation of fish GLUT4 at the mRNA, protein and promoter activity levels.

5.1. Regulation of GLUT4 mRNA levels in fish

In mammals, GLUT4 is mainly expressed in insulin-sensitive tissues, namely skeletal and cardiac muscle and adipose tissue. In skeletal muscle, GLUT4 is the main transporter expressed and it has been estimated that it accounts for approximately 70% of the basal glucose transport in this tissue (reviewed in [29]). In fish, the pattern of the tissue expression of GLUT4 at the mRNA level has only been examined in two different species: the brown trout [26] and the Atlantic cod [56]. In these two fish species, the level of GLUT4 mRNA was shown to be highest in red (slow) and white (fast) skeletal muscle. In Atlantic cod, the heart also showed high levels of GLUT4 mRNA but not in brown trout. Lower levels of GLUT4 mRNA were observed in adipose tissue, gill, kidney and other tissues in these two species. In rainbow trout, GLUT4 mRNA transcripts have also been detected in white skeletal muscle [57]. Overall, the pattern of tissue expression of GLUT4 transcripts in fish agrees well with the reported main expression of GLUT4 in the mammalian skeletal muscle, coinciding with this tissue as the primary insulin target and major site for glucose disposal. The presence of the GLUT4 protein in skeletal muscle and adipose tissue of trout has been confirmed by immunoblotting [31,32].

The expression of the GLUT4 gene is known to be subjected to an important transcriptional regulation that determines the protein levels of GLUT4 in skeletal and cardiac muscle and in adipose tissue in mammals. In mammals, a number of factors are known to influence GLUT4 expression, most notably the nutritional and dietary status and hormones (e.g. insulin, insulin-like growth factor I (IGF-I) and thyroid hormones) (reviewed in [28,58]). In fish, most current evidence regarding the regulation of GLUT4 expression is at the mRNA level and in skeletal

muscle, due to the importance of this tissue in glucose homeostasis. As in mammals, the expression of GLUT4 mRNA levels increase during muscle cell differentiation in trout, as was demonstrated by the gradual increase in GLUT4 mRNA levels during the differentiation process of trout muscle cells in culture from myoblasts to myotubes [59]. In addition, the amount of immunoreactive GLUT4 was observed to be higher in trout myotubes than in myoblasts [32], strongly suggesting that GLUT4 can be considered a marker of muscle differentiation also in fish.

5.1.1. Regulation of GLUT4 mRNA levels by insulin in fish

In mammals, insulin exerts its hypoglycemic action in part by increasing the expression of GLUT4 in skeletal muscle. Data in fish also indicates that the expression of GLUT4 mRNA in skeletal muscle appears to be regulated by circulating insulin levels in a muscle type specific manner. As it is well known, fish skeletal muscle can be differentiated into two anatomically and functionally different types of muscle: white muscle, that is a fast, anaerobic muscle that permits sudden bursts of motion, and red muscle, that is a slow, aerobic muscle that permits sustained locomotion. Although red muscle only comprises 5-10% of the body weight in fish (in contrast to >50% for white muscle), it has a higher glucose uptake rate and insulin receptor density than white muscle. Interestingly, the *in vivo* regulation of GLUT4 mRNA levels by circulating insulin in trout appears to take place only in red skeletal muscle. Decreases in circulating insulin levels caused by fasting or by feeding a diet containing low protein and high carbohydrate levels were associated with a decrease in GLUT4 mRNA levels in red but not white skeletal muscle in trout [60]. In contrast, increases in circulating insulin levels caused by insulin or arginine (an insulin secretagogue in fish; [24]) administration were accompanied by an increase in GLUT4 mRNA levels in red but not white skeletal muscle in trout [60]. More recently, it was shown that GLUT4 expression in white skeletal muscle of trout fed a diet rich in carbohydrates was not affected [57]. Therefore, there is strong evidence suggesting that GLUT4 mRNA levels in red skeletal muscle may be regulated *in vivo* by circulating insulin in trout, as in mammals. However, these observations raised the question as to whether the expression of GLUT4 could be regulated in white skeletal muscle, given that it accounts for the bulk of glucose taken up by skeletal muscle. In contrast to trout, GLUT4 mRNA levels in the white muscle of Atlantic cod increased after fasting and decreased after refeeding [56], suggesting the possibility of species-specific differences in the regulation of GLUT4 in this tissue.

In vitro studies using a primary culture of trout skeletal muscle cells have assessed the effects of insulin and IGF-I on GLUT4 mRNA levels. The results obtained from these studies clearly showed that insulin and IGF-I increased the GLUT4 mRNA content in myoblasts and in myotubes [59] and support the notion that insulin can indeed regulate GLUT4 mRNA levels in trout skeletal muscle by acting directly on muscle cells. Since insulin is known to stimulate the uptake of glucose by trout skeletal muscle cells *in vitro* [32], it has been hypothesized that this effect of insulin may have been due, at least in part, to its effects on GLUT4 expression. Therefore, it appears that the hypoglycemic effects of insulin in fish, as in mammals, may involve the stimulation of GLUT4 mRNA expression in skeletal muscle.

5.1.2. Regulation of GLUT4 mRNA levels by contractile activity in fish

In mammals, exercise is known to increase the transcription of the GLUT4 gene and, consequently, to increase glucose utilization in skeletal muscle [61,62]. The exercise-induced GLUT4 mRNA expression in the mammalian skeletal muscle is believed to be mediated largely by AMP-dependent protein kinase (AMPK), an energy sensor that is activated when increases in the AMP/ATP ratio occur, as in response to exercise [63]. In trout, swimming-induced exercise was also recently shown to promote glucose uptake and utilization in skeletal muscle [64]. Importantly, swimming-induced exercise increased the mRNA levels of GLUT4 in red and white skeletal muscle in trout, as in mammals [65], supporting the notion that the increase in GLUT4 in skeletal muscle may have been responsible, at least in part, for the decrease in circulating glucose levels and increased uptake and utilization of glucose by skeletal muscle of exercised trout [64]. Furthermore, pharmacological activation of AMPK by AICAR or metformin in trout skeletal muscle cells in culture caused an increase in GLUT4 mRNA levels [66]. Given that swimming-induced exercise increased AMPK activity in red and white skeletal muscle in trout (Magnoni and Planas, unpublished observations), there is strong evidence to believe that swimming-induced exercise increases GLUT4 mRNA levels in skeletal muscle through the induction of AMPK activity.

5.2. Regulation of the activity of the fish GLUT4 promoter

It is known that changes in the mRNA levels of GLUT4 in skeletal muscle in mammals (i.e. increases during exercise and decreases during states of insulin deficiency) are due to alterations in the transcription rate of the GLUT4 gene [29]. In mammals, the cis-regulatory region of the GLUT4 gene is relatively well characterized and is known to contain motifs that are important for the tissue-specific expression of the GLUT4 gene and its regulation. As indicated above (section 5.1.1), one of the most effective inducers of GLUT4 mRNA and protein expression in mammals is insulin. However, the regulation of the transcription of the GLUT4 gene by insulin in mammals is not well understood, particularly in the light of published data indicating that, paradoxically, insulin inhibits the transcription of the GLUT4 gene [67,68]. Interestingly, a recent study reported that the activity of a fish (i.e. Fugu) GLUT4 promoter, when expressed in mammalian muscle L6 cells, is inhibited by insulin [30]. Although the mechanism by which insulin represses the activity of the GLUT4 gene is not known in mammals, deletion analyses of the Fugu GLUT4 promoter have indicated that the region of the Fugu GLUT4 gene that is downstream of the main transcription start site may be sufficient for mediating the inhibitory effects of insulin on GLUT4 transcription [30]. Further studies are clearly needed to resolve the question of the paradoxical effects of insulin on GLUT4 gene transcription. Despite the inhibition of the activity of the Fugu GLUT4 gene promoter by insulin, other stimuli known to increase GLUT4 mRNA levels have been shown to cause an induction of Fugu GLUT4 promoter activity. First, ligand activation of PPAR γ , which in mammals results in an increase of GLUT4 mRNA levels [69], increased the activity of the Fugu GLUT4 promoter expressed in L6 cells [30]. Second, electrical stimulation of mouse C2C12 myotubes expressing the Fugu GLUT4 promoter resulted in an increase in the activity of the Fugu GLUT4 promoter. Given the recent demonstration that swimming-induced skeletal

muscle activity in trout increased the mRNA levels of GLUT4 in trout skeletal muscle [65], these results suggest that induction of contractile activity in skeletal muscle cells results in the transcriptional activation of the GLUT4 gene, resulting in increased GLUT4 mRNA levels that, in turn, may increase the amount of GLUT4 and, consequently, the entry and utilization of glucose in skeletal muscle in fish.

5.3. Regulation of GLUT4 protein levels in fish

To date, studies on the regulation of GLUT4 protein levels in fish are limited to salmonid species. The availability of a polyclonal antibody against okGLUT4 made possible the localization and the quantification of GLUT4 in trout skeletal muscle. By performing immunolocalization studies of GLUT4 in trout skeletal muscle cells in culture, an increase in the amount of total GLUT4 protein was observed during the differentiation of myoblasts into myotubes [32]. Subsequent studies showed that the total content of GLUT4 differs between the two types of skeletal muscle in trout, with red muscle containing a higher amount of GLUT4 than white muscle [70]. In agreement with changes in the expression of GLUT4 at the mRNA level, the total amount of GLUT4 protein in red muscle increased in trout stimulated with insulin *in vivo* and decreased after fasting. On the other hand, insulin administration failed to increase GLUT4 protein content in trout white muscle [32], supporting the lack of changes of GLUT4 mRNA levels previously described [60]. Interestingly, nutritional factors regulate GLUT4 mRNA and protein levels in white muscle in different manners. In trout, fasting decreased the amount of GLUT4 protein in white muscle [32], whereas no changes in mRNA levels were observed in the same condition [60], suggesting that post-transcriptional regulation of GLUT4 expression may take place in white skeletal muscle in fish. Therefore, it appears that insulin plasma levels may regulate the amount of GLUT4 present in red skeletal muscle in fish and strongly suggest that insulin may stimulate the *de novo* synthesis of GLUT4, at least in red skeletal muscle, by increasing the mRNA levels of GLUT4. The lack of effects after insulin administration *in vivo* on GLUT4 mRNA and protein levels in white muscle in trout are puzzling in the light of data showing that glucose uptake increases in white muscle after a glucose load in trout and that this tissue contributes about five times more than red muscle to the total glucose uptake when expressed as percent of the total body mass [23]. Further studies are required to understand the factors and mechanisms involved in the regulation of glucose uptake in white skeletal muscle in fish.

As part of the complex regulation of GLUT4, the translocation of this glucose transporter to the PM from intracellular vesicles is highly dynamic and is regulated by a number of factors [71], representing an efficient mechanism that allows a fast equilibration of glucose levels at either side of the PM in response to a hypoglycemic stimulus. In fish, insulin has been shown to increase the PM levels of GLUT4 in *in vitro* stimulated trout muscle cells in culture [32], demonstrating that insulin stimulates glucose uptake in fish skeletal muscle cells by increasing the levels of the GLUT4 protein at the PM, as in mammals. Other stimuli that have been shown to increase the uptake of glucose by trout myocytes and that also increase the cell surface levels of GLUT4 are AMPK activators (i.e. AICAR and metformin) [66] and the pro-inflammatory cytokine tumor necrosis factor α (TNF α) [72]. These results indicate that the regulation of the

total amount of GLUT4 protein in skeletal muscle and, more importantly, the cell surface levels of GLUT4 in skeletal muscle cells are similar between fish and mammals, evidencing a remarkable degree of conservation of the mechanism(s) by which insulin exerts its hypoglycemic effects on skeletal muscle.

6. Regulation of the traffic of fish GLUT4

In mammals, the main feature that characterizes GLUT4 in skeletal muscle and adipose tissue and makes it unique is its ability to translocate to the PM in response to insulin [15,73]. This greatly increases the capacity of the cells to uptake glucose during the postprandial state, which is crucial to properly maintain glucose homeostasis. Notwithstanding, evidence in mammalian cells clearly indicates that in the basal state GLUT4 is not static; instead, GLUT4 circulates among numerous intracellular compartments, such as the trans-Golgi network (TGN), early and late endosomes, a specialized insulin responsive compartment (IRC), as well as the PM [71,74-75]. The amount of GLUT4 present at the PM in the basal state corresponds to about only 5-10% of the total GLUT4 protein, whereas the remaining 90-95% is sequestered intracellularly in the IRC compartment [76-78].

The intracellular trafficking characteristics of the two glucose transporters identified in salmonids (btGLUT4 and okGLUT4) have been studied in comparison with mammalian GLUT4 mainly when expressed in heterologous systems (mammalian adipocytic or myoblastic cell lines), but also as the endogenous GLUT4 in primary cultured trout myocytes. In 3T3-L1 adipocytes transiently expressing separately btGLUT4 or okGLUT4 under steady-state conditions, btGLUT4 exhibited significantly higher protein levels at the PM (30-40%), also okGLUT4 but to a lesser extent (15-20%), than rat GLUT4 (10-15%) [31,79]. This was not only observed in adipocytes, since btGLUT4 was present also at the PM at higher levels (20-25%) than rat GLUT4 (10-15%) when stably-expressed in L6 muscle cells [32]. Importantly, the basal localization of endogenous GLUT4 at the PM in trout myocytes in culture was also relatively high [32]. Therefore, under basal or unstimulated conditions fish GLUT4 appears to be less efficiently retained in the cytosol in adipocytes and myocytes than mammalian GLUT4, suggesting differences in the mechanisms responsible for the intracellular retention of GLUT4 between fish and mammals (see below). Furthermore, based on the observed differences in PM localization between fish GLUT4s under basal conditions, with okGLUT4 being more similar to its mammalian counterparts than btGLUT4, it has been suggested that the different traffic behavior of these two fish GLUT4 protein variants may be related to differences in characteristic regulatory features in the GLUT4 protein sequence (i.e. N- and C-terminal protein motifs) (see section 3; [79]).

Moreover, the ability of fish GLUT4s to respond to insulin has been also evaluated. The first studies trying to demonstrate that a fish GLUT4 translocates to the PM upon insulin stimulation were performed in *Xenopus* oocytes [31]. Nevertheless, the system was not appropriate to study the translocation of GLUT4 and oocytes expressing okGLUT4 or a rat GLUT4 did not show differences in transporter localization within the cell in response to insulin [31]. Instead,

the 3T3-L1 adipocyte cell system was used successfully to demonstrate that both okGLUT4 and btGLUT4 were able to significantly translocate to the PM after insulin treatment [31,79], as it occurs in mammals. Moreover, insulin-stimulated translocation to the PM of btGLUT4 was demonstrated in L6 myoblasts and differentiated myotubes stably-expressing the fish GLUT4 transporter [32]. Therefore, the fish homologs of GLUT4 were shown to be insulin responsive like their mammalian counterpart, despite their higher PM localization at steady-state.

As previously mentioned, GLUT4 in mammals is distributed inside the cells in two major storage compartments, the IRC and the endosomal system [75,80]. Interestingly, btGLUT4 showed only partial co-localization with rat GLUT4 when both were co-expressed either in 3T3-L1 adipocytes [79] or in L6 muscle cells [32]. This observation, together with the fact that btGLUT4 showed lower levels of retention in intracellular compartments during basal conditions although it still responded to insulin stimulation in both cell types [32,79], suggested that btGLUT4 is equally distributed between the specialized IRC and the endosomal compartment, from where it cycles continuously with the PM. Moreover, both in 3T3-L1 adipocytes and L6 muscle cells, the higher PM levels observed for btGLUT4 were shown to be due to a faster externalization rate rather than to a decrease in the rate of endocytosis [32,79].

In mammals, several proteins have been described to interact with GLUT4 to regulate its intracellular traffic and to maintain the proteins sequestered in the IRC. For example, the Golgi-localized γ -ear-containing Arf-binding protein (GGA) has been described to function as a traffic controller of newly synthesized GLUT4 from the TGN to the IRC [73,81]. In this step, sortilin has been described also to have a key role, as GLUT4 does not contain the specific targeting motif to be recognized by GGA as a cargo molecule [82]. More recently, the insulin-regulated aminopeptidase (IRAP), which co-localizes with GLUT4 in intracellular vesicles, has been shown to play a role in the sorting of GLUT4 from endosomes into the IRC [83]. Moreover, a protein named TUG (tether containing a UBX domain for GLUT4), has been reported to interact with the large intracellular GLUT4 loop present between TMVI and TMVII and to tether GLUT4 to intracellular vesicles through its interaction, via its UBX domain, with cellular membranes [84]. The possible roles of several GLUT4-interacting proteins in the regulation of the traffic of the fish GLUT4 isoforms have been explored in 3T3-L1 adipocytes expressing the corresponding mammalian orthologs. In particular, the adaptor protein GGA has been reported to be involved in the early sorting steps of GLUT4 from the TGN. The expression in 3T3-L1 adipocytes of rat GLUT4 together with wild-type GGA or a dominant-interfering form of GGA (GGA-DN) demonstrated that GGA is required for GLUT4 to reach the IRC because the insulin-stimulated translocation of rat GLUT4 to the PM was completely blunted in the presence of GGA-DN [40,73]. Interestingly, the intracellular traffic of btGLUT4 and okGLUT4 in 3T3-L1 adipocytes showed differences with regards their sensitivities to GGA because the traffic of btGLUT4 to the PM either under basal or insulin-stimulated conditions was only partially suppressed by co-expression with GGA-DN whereas okGLUT4 showed an identical response as that of rat GLUT4 [79]. These results suggested that okGLUT4 may traffic in adipocytes through the same pathway as mammalian GLUT4, but that btGLUT4 may be in part escaping the regulated biosynthetic traffic route, moving to the PM following a GGA-

independent pathway. In agreement with the different intracellular distribution observed between btGLUT4 and rat GLUT4 [32], the traffic of btGLUT4 to the PM may be occurring via the constitutive pathway used by Glut1 or the transferrin receptor [37,73] (Figure 7). It is known that GLUT4, upon arriving in the IRC, acquires the capability to respond to insulin and to translocate to the PM. When a plasmid coding rat GLUT4 is transfected into 3T3-L1 adipocytes, the cells require 6 to 9 hours to produce the new protein and to target it to the IRC [73,85]. In contrast, both okGLUT4 and btGLUT4, when expressed in the same cellular system, undergo insulin-stimulated translocation only 3 hours after transfection [79], suggesting that fish GLUT4 undergoes faster synthesis, processing or traffic. Interestingly, okGLUT4 showed a temporal response that was intermediate between rat GLUT4 and btGLUT4, but closer to the latter, despite showing a similar sensitivity towards GGA as the mammalian GLUT4.

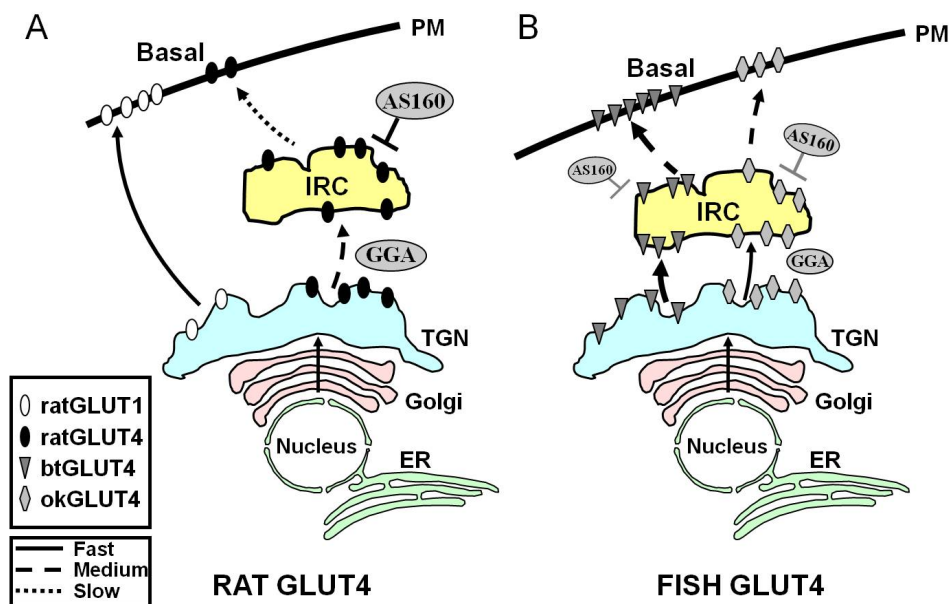

Figure 7. Schematic model illustrating differences in traffic between fish GLUT4s and rat GLUT4 and Glut1 during the basal state in adipocytes. In (A), the traffic of newly synthesized rat GLUT4 is shown to take place through the Golgi and the trans-Golgi network (TGN) and into the insulin-responsive compartment (IRC) in a sorting process that is dependent upon the adaptor protein GGA. In the basal state, rat GLUT4 is mainly sequestered into the IRC, a process that is regulated by AS160 and that requires the F⁵QQL⁸ amino terminal motif of GLUT4. In contrast, after biosynthesis, Glut1 directly travels from the TGN to the plasma membrane (PM) in a GGA-independent process. In (B), the traffic of newly synthesized trout (btGLUT4) or salmon (okGLUT4) GLUT4 is shown. We postulate that the high levels of btGLUT4 at the PM appear to be due to an increased exocytic rate, as a result of btGLUT4 following a GGA-independent route from the TGN to the IRC and by showing less AS160-regulated sequestration at the IRC than rat GLUT4. We hypothesize that the different trafficking behavior of btGLUT4 may be related to the different sequence in its N-terminal motif (F⁵QHL⁸). The traffic behavior of okGLUT4 (F⁵QQL⁸) appears to be intermediate between that of rat GLUT4 and btGLUT4. ER: endoplasmic reticulum.

As previously mentioned in section 3, among the different regulatory amino acid motifs found in GLUT4 in mammals, the F⁵QQL⁸ targeting motif in the N-terminus has been shown to be important for GLUT4 sequestration into the IRC and insulin-stimulated translocation to the PM [85-88]. Interestingly, in addition to the fact that both fish GLUT4 transporters have a shorter N-terminal domain, the F⁵QQL⁸ motif shows one conserved amino acid substitution in

okGLUT4 (F⁵QQL⁸), and it is less conserved in btGLUT4 (F⁵QHL⁸), where the double residue substitution causes important size and charge changes (Figure 8A). The possibility that these sequence differences were able to account for the increased basal cell surface levels observed for btGLUT4 was investigated (Capilla and Planas, unpublished data). Figure 8B shows that mutation of the btGLUT4 motif F⁵QHL⁸ to F⁵QQI⁸ caused a slight decrease in basal PM levels; however, mutation of the F⁵QHL⁸ motif to F⁵QQL⁸ significantly reduced the cell surface levels of btGLUT4 to levels comparable to those of okGLUT4 or the mammalian GLUT4. These results indicate that specific amino acid motifs as well as the folding of the molecule appear to be important for the intracellular domains of the GLUT4 molecule to interact with the different regulatory proteins for proper traffic and specific compartment localization and/or retention.

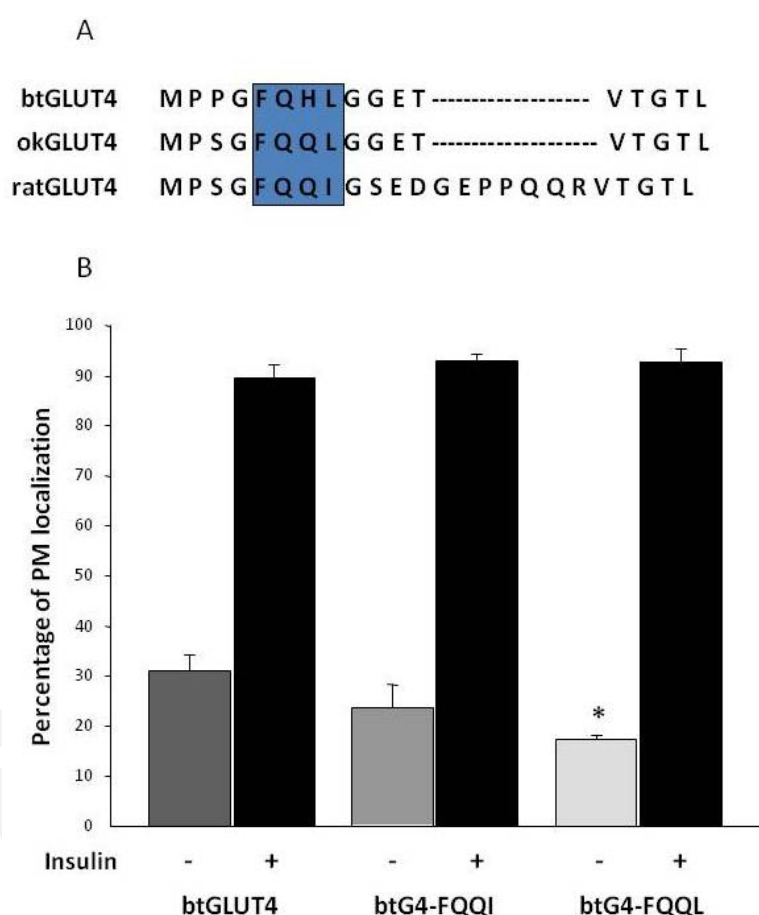

Figure 8. The elevated basal cell surface levels of btGLUT4 are reduced by mutating the F⁵QHL⁸ motif. (A) Amino acid sequence alignment of the N-terminal region of rat, brown trout (btGLUT4, AF247395) and coho salmon (okGLUT4, AF502957) GLUT4 molecules. The box encloses the important trafficking motif F⁵QQI⁸ partially conserved in the fish species. (B) Differentiated 3T3-L1 adipocytes expressing either btGLUT4 or any of the two point mutants (btGLUT4-FQQI or btGLUT4-FQQL) were incubated with or without insulin (100 nM, 30 min). Data is presented as percentage (mean \pm SEM) of cells showing a complete plasma membrane (PM) rim obtained by counting 100 cells per condition in 3 independent experiments. Statistical analysis was performed by unpaired t-test against the wild type btGLUT4 at basal or insulin-stimulated conditions respectively (* denotes significance at $p < 0.05$).

An earlier study in mammals using chimeras between GLUT4 and Glut1 demonstrated that substituting the N-terminus and the intracellular loop of Glut1 for those of GLUT4 is sufficient to confer to the chimeric Glut1 protein the characteristics of GLUT4 in 3T3-L1 adipocytes [89]. Thus, in order to identify the protein domains in trout GLUT4 that confer its particular traffic characteristics (i.e. lower intracellular retention; higher PM levels under basal conditions), chimeric proteins were created that have the N-terminus (btN) or the intracellular loop (btL) of btGLUT4 in a rat GLUT4 backbone and were named btN-GLUT4 or btL-GLUT4, respectively. These constructs were then stably expressed in 3T3-L1 cells and their capacity to be retained in the cytosol under basal conditions and to respond to insulin were analyzed (Simoes, Planas and Camps, unpublished results). The results obtained indicated that all constructs were able to translocate to the PM in response to insulin but with certain differences among them (Figure 9). First, the insulin-stimulated translocation of btGLUT4 was lower than that of rat GLUT4. Second, btN-GLUT4 had the weakest response to insulin, suggesting a role for the N-terminus in the correct targeting of GLUT4 to the IRC or in the translocation of GLUT4 to the PM. Third, the substitution of the cytoplasmic loop in btL-GLUT4 caused a reduction in the response of rat GLUT4 to insulin comparable to that of btGLUT4. These preliminary results support the idea that the N-terminus and the cytoplasmic loop of GLUT4 are responsible for some of the trafficking differences between btGLUT4 and rat GLUT4.

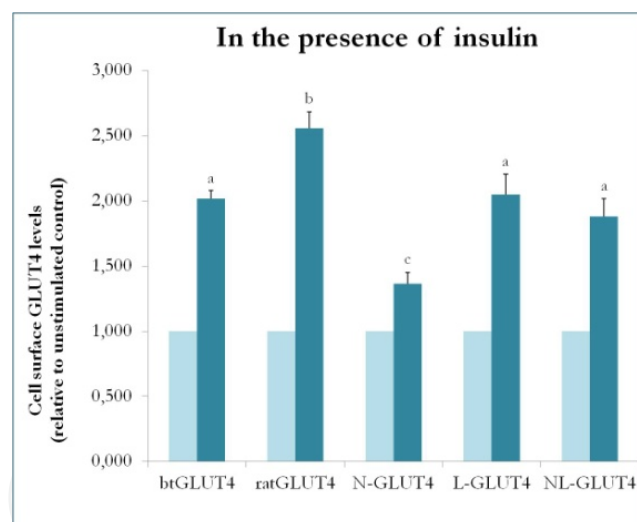

Figure 9. Cell surface levels of various GLUT4 constructs in the presence of insulin. N-GLUT4 and L-GLUT4 represent constructs with the amino terminus (N) or the intracellular loop (L) of btGLUT4 in a rat GLUT4 backbone, respectively. Differentiated 3T3-L1 adipocytes expressing the various GLUT4 constructs were incubated in the absence or presence of insulin (100nM) for 30 min and the determination of surface GLUT4 levels was performed as described in [32]. Cell surface GLUT4 is expressed relative to the unstimulated control for each cell line. Different letters indicate statistically significant differences ($p < 0.05$).

Following insulin stimulation, mammalian GLUT4 traffics and fuses with the PM, increasing its presence in the cell surface up to 10-fold; thus, supporting the increase in glucose uptake observed after feeding. Insulin increases the number of transporters at the PM not only by enhancing exocytosis but also by decreasing the rate of endocytosis [90-92]. Insulin exerts its

effects through two different intracellular signaling pathways [15,93]. The first is the well-known pathway of phosphatidylinositol-3-kinase (PI3K)/protein kinase B (PKB), also known as Akt, that is necessary for GLUT4 translocation to occur [94,95] but not sufficient [96]. The second pathway is that including the Cbl associated protein (CAP), which binds the insulin receptor and activates a small GTPase from the Rho family named TC10, and that was described in adipocytes [97]. However, the TC10 pathway appears not to be involved in muscle cells, in which another Akt-independent input was shown to contribute to the cytoskeleton remodeling required for complete GLUT4 translocation [98,99]. Downstream of Akt, a protein named Akt substrate of 160 KDa (AS160) or TCB1D4, has been found to be the key to communicate the phosphorylation cascade initiated by insulin with the vesicle trafficking machinery [100,101]. AS160 has 6 residues of threonine/serine that can be phosphorylated to inhibit its activity, and contains a GTPase-activating protein (GAP) domain that in the basal state inactivates a series of Rab proteins, small GTPases from the Ras superfamily responsible of membrane trafficking [100]. Phosphorylation of AS160 by Akt inhibits its GAP activity, allowing the activation of the Rab proteins; thus, causing the translocation of GLUT4 to the PM [101,102]. The Rab members identified as responsible for GLUT4 trafficking in mammals are Rab8a, Rab10 and Rab14 [103-106]. In addition to regulating the movement of GLUT4 vesicles, AS160 has been demonstrated to be required for fully retaining GLUT4 into the IRC [107]. To demonstrate that AS160 phosphorylation is critical for GLUT4 translocation in mammals, a dominant-inhibitory form of AS160 was created by mutating 4 of its 6 phosphorylation sites (AS160-4P) [101]. When co-expressed in a cellular system together with rat GLUT4, the translocation of this molecule to the PM was blocked, as well as the increase in glucose uptake observed after insulin incubation [40,108]. Regarding their sensitivity towards AS160-4P, clear differences were observed between okGLUT4 and btGLUT4, with the former showing similar properties as those of mammalian GLUT4, and the latter being unaffected [79]. These results were in agreement with the differences observed between the two fish GLUT4 proteins in terms of their intracellular retention and support the hypothesis that AS160 may sequester okGLUT4, but not btGLUT4, in the IRC and that btGLUT4 may be more widely distributed inside the cell than the other GLUT4 transporters. Moreover, since the results obtained for btGLUT4 towards AS160 sensitivity agreed with those reported previously for a GLUT4-F5A mutant [40,73], the faster exocytic rate of btGLUT4 was suggested to be due to the lack of a conserved FQQI motif [32,79].

In summary, by investigating the trafficking characteristics of the two fish GLUT4 proteins (btGLUT4 and okGLUT4) compared with mammalian GLUT4 and Glut1, it is clear that important differences exist between these transporters (Figure 7). In this regard, okGLUT4 behaves in many aspects similarly to mammalian GLUT4 due to its sensitivity towards GGA and AS160; thus, supporting a role for these molecules in the regulation of the traffic of okGLUT4 synthesized *de novo* from the TGN into the IRC, and from the TGN into the PM in response to insulin, respectively. In contrast, btGLUT4 appears to be less regulated, trafficking to the IRC independently of GGA, as well as being retained in the IRC and exiting to the PM only in part under the control of AS160; therefore, moving towards the cell surface possibly, in part, through a constitutive pathway as that used by Glut1.

7. Conclusions and perspectives

All the evidence accumulated to date on the function and regulation of GLUT4 in fish indicates that the various molecular and cellular mechanisms regulating the amount of GLUT4 that is present at the cell surface in skeletal muscle and adipose tissue cells and that determine the amount of glucose uptake have been relatively well conserved during evolution from fish to mammals. Importantly, GLUT4 in fish is regulated by insulin at the level of mRNA and total protein amount as well as at the level of its abundance at the PM. In fish, like in mammals, GLUT4 responds to the effects of insulin by facilitating the uptake of glucose in insulin-sensitive tissues such as skeletal muscle. Therefore, GLUT4 plays an important role in mediating the hypoglycemic effects of insulin from fish to mammals and underscores the importance of the maintenance of glucose homeostasis, and the role of GLUT4 in this process, throughout vertebrates. However, the presence of a seemingly well conserved insulin-regulated mechanism of glucose transport involving GLUT4 contrasts with the relative glucose intolerance of teleost fish, that is evidenced by the lower ability of fish to clear a glucose load, when compared to mammals. It was initially hypothesized that the persistent hyperglycemia in fish may have been due to the possible lack of an insulin-regulated GLUT [25], given that fish have functional insulin receptors [109] and insulin is involved in the postprandial regulation of blood glucose levels [24]. The demonstration of the participation of an insulin-regulatable glucose transport system involving GLUT4 in skeletal muscle and adipose tissue of fish [26,31-32,59-60,70,79] rules out that fish may experience peripheral resistance to insulin. What today appears as a likely contribution to explain the poor regulation of glucose plasma levels in fish, when compared to mammals, are the particular transport characteristics and intracellular trafficking behavior of fish GLUT4. Functionally, fish GLUT4 differs from mammalian GLUT4 in that it has a lower affinity for glucose and a wider substrate specificity. In addition, the intracellular traffic of fish GLUT4 is somewhat different than that of mammalian GLUT4. Although insulin stimulates the translocation of fish GLUT4 to the PM, the intracellular route(s) used by fish GLUT4 to reach the PM are not as dependent on proteins required for the intracellular sorting and retention of mammalian GLUT4, which leads to the proportionally higher levels of fish GLUT4 at the PM under basal conditions. Differences in the intracellular traffic behavior of fish GLUT4, when compared to mammalian GLUT4, are likely due to differences in key protein motifs in GLUT4. Therefore, we propose that during evolution from fish to mammals, the control of glucose homeostasis has improved possibly due to the increase in the affinity of GLUT4 for glucose and to the improvement of the intracellular sorting and retention mechanisms of GLUT4 in insulin-sensitive cells.

Interestingly, GLUT4 from different fish species that contain slightly different amino acid sequences in key trafficking motifs can be considered natural mutants of mammalian GLUT4 and used to identify and further characterize amino acid motifs or protein domains in mammalian GLUT4 that are important for the regulation of the traffic of mammalian GLUT4. Our studies on the traffic behavior of chimeric GLUT4 proteins incorporating fish GLUT4 protein motifs into a mammalian GLUT4 backbone represent a first step in that direction. Given that the traffic of GLUT4 is dependent on the binding of GLUT4 to sorting and trafficking proteins that are not fully characterized in mammals, studies comparing the traffic of fish and

mammalian GLUT4 could potentially identify important binding partners of mammalian GLUT4 that do not interact or interact poorly with fish GLUT4 motifs. Consequently, the comparative study of GLUT4 from evolutionarily distant species could contribute to our understanding of the biology of GLUT4 in health and disease.

Acknowledgements

Most of the work of the Planas laboratory described here has been supported by grants AGL2002-03987, AGL2005-01230, CSD2007-0002 and AGL2009-07006 to JVP from the Spanish Ministry of Science and Education. The authors would like to particularly thank Dr. Amira Klip (Hospital for Sick Children, University of Toronto) and Dr. Jeffrey Pessin (Albert Einstein College of Medicine, New York) for their stimulating collaborations and interest in the comparative aspects of GLUT4 biology.

Author details

Rubén Marín-Juez^{1,3}, Encarnación Capilla¹, Francisco Carvalho-Simoes^{2,3}, Marta Camps^{2,3} and Josep V. Planas^{1,3*}

*Address all correspondence to: jplanas@ub.edu

1 Departament de Fisiologia i Immunologia, Facultat de Biologia, Universitat de Barcelona, Spain

2 Departament de Biologia Molecular, Facultat de Biologia, Universitat de Barcelona, Spain

3 Institut de Biomedicina de la Universitat de Barcelona (IBUB), Barcelona, Spain

References

- [1] James DE, Brown R, Navarro J, Pilch PF. Insulin-regulatable tissues express a unique insulin-sensitive glucose transport protein. *Nature*. 1988;333(6169):183–5.
- [2] Fukumoto H, Kayano T, Buse JB, Edwards Y, Pilch PF, Bell GI, et al. Cloning and characterization of the major insulin-responsive glucose transporter expressed in human skeletal muscle and other insulin-responsive tissues. *J Biol Chem*. 1989;264(14):7776–9.
- [3] Birnbaum MJ. Identification of a novel gene encoding an insulin-responsive glucose transporter protein. *Cell*. 1989;57(2):305–15.

- [4] Charron MJ, Brosius FC3, Alper SL, Lodish HF. A glucose transport protein expressed predominately in insulin-responsive tissues. *Proc Natl Acad Sci USA*. 1989;86(8):2535–9.
- [5] Kaestner KH, Christy RJ, McLenithan JC, Braiterman LT, Cornelius P, Pekala PH, et al. Sequence, tissue distribution, and differential expression of mRNA for a putative insulin-responsive glucose transporter in mouse 3T3-L1 adipocytes. *Proc Natl Acad Sci USA*. 1989;86(9):3150–4.
- [6] Huang S, Czech MP. The GLUT4 glucose transporter. *Cell Metab*. 2007;5(4):237–52.
- [7] Keller K, Strube M, Mueckler M. Functional expression of the human HepG2 and rat adipocyte glucose transporters in *Xenopus* oocytes. Comparison of kinetic parameters. *J Biol Chem*. 1989;264(32):18884–9.
- [8] Burant CF, Bell GI. Mammalian facilitative glucose transporters: evidence for similar substrate recognition sites in functionally monomeric proteins. *Biochemistry*. 1992;31(42):10414–20.
- [9] Rumsey SC, Daruwala R, Al-Hasani H, Zarnowski MJ, Simpson IA, Levine M. Dehydroascorbic acid transport by GLUT4 in *Xenopus* oocytes and isolated rat adipocytes. *J Biol Chem*. 2000;275(36):28246–53.
- [10] Uldry M, Ibberson M, Hosokawa M, Thorens B. GLUT2 is a high affinity glucosamine transporter. *FEBS Lett*. 2002;524(1-3):199–203.
- [11] Mueckler M. Facilitative glucose transporters. *Eur J Biochem*. 1994;219(3):713–25.
- [12] Rayner DV, Thomas ME, Trayhurn P. Glucose transporters (GLUTs 1-4) and their mRNAs in regions of the rat brain: insulin-sensitive transporter expression in the cerebellum. *Can J Physiol Pharmacol*. 1994;72(5):476–9.
- [13] Shepherd PR, Kahn BB. Glucose transporters and insulin action--implications for insulin resistance and diabetes mellitus. *N Engl J Med*. 1999;341(4):248–57.
- [14] Saltiel AR, Pessin JE. Insulin signaling pathways in time and space. *Trends Cell Biol*. 2002;12(2):65–71.
- [15] Bryant NJ, Govers R, James DE. Regulated transport of the glucose transporter GLUT4. *Nat Rev Mol Cell Biol*. 2002;3(4):267–77.
- [16] Kusari J, Verma US, Buse JB, Henry RR, Olefsky JM. Analysis of the gene sequences of the insulin receptor and the insulin-sensitive glucose transporter (GLUT-4) in patients with common-type non-insulin-dependent diabetes mellitus. *J Clin Invest*. 1991;88(4):1323–30.
- [17] Friedel S, Antwerpen B, Hoch A, Vogel C, Grassl W, Geller F, et al. Glucose transporter 4 gene: association studies pertaining to alleles of two polymorphisms in extremely obese children and adolescents and in normal and underweight controls. *Ann N Y Acad Sci*. 2002;967:554–7.

- [18] Karnieli E, Armoni M. Transcriptional regulation of the insulin-responsive glucose transporter GLUT4 gene: from physiology to pathology. *Am J Physiol Endocrinol Metab.* 2008;295(1):E38–45.
- [19] Wood IS, Trayhurn P. Glucose transporters (GLUT and SGLT): expanded families of sugar transport proteins. *Br J Nutr.* 2003;89(1):3–9.
- [20] Polakof S, Mommsen TP, Soengas JL. Glucosensing and glucose homeostasis: from fish to mammals. *Comp Biochem Physiol B Mol Biol* 2011;160:123-149.
- [21] Moon TW. Glucose intolerance in teleost fish: fact or fiction? *Comp Biochem Physiol B Biochem Mol Biol.* 2001;129(2-3):243–9.
- [22] Cowey JY, Walton MJ. Intermediary metabolism. In: Halver JE, editor. *Fish Nutrition.* 2nd ed. San Diego: Academic Press; 1989. pp. 259–329.
- [23] Blasco J, FernandezBorras J, Marimon I, Requena A. Plasma glucose kinetics and tissue uptake in brown trout in vivo: Effect of an intravascular glucose load. *J Comp Physiol B.* 1996;165(7):534–41.
- [24] Mommsen TP, Plisetskaya EM. Insulin in Fishes and Agnathans-History, Structure, and Metabolic-Regulation. *Rev Aquat Sci.* 1991;4(2-3):225–59.
- [25] Wright JRJ, O'Hali W, Yang H, Han XX, Bonen A. GLUT-4 Deficiency and severe peripheral resistance to insulin in the teleost fish tilapia. *Gen Comp Endocrinol.* 1998;111(1):20–7.
- [26] Planas JV, Capilla E, Gutiérrez J. Molecular identification of a glucose transporter from fish muscle. *FEBS Lett.* 2000;481(3):266–70.
- [27] Welch KC, Allalou A, Sehgal P, Cheng J, Ashok A. Glucose Transporter Expression in an Avian Nectarivore: The Ruby-Throated Hummingbird (*Archilochus colubris*). *PLoS ONE.* 2013;8(10):e77003.
- [28] Louis A, Muffato M, Roest Crolius H. Genomicus: five genome browsers for comparative genomics in eukaryota. *Nucleic Acids Res.* 2013;41:D700-705.
- [29] Zorzano A, Palacín M, Gumà A. Mechanisms regulating GLUT4 glucose transporter expression and glucose transport in skeletal muscle. *Acta Physiol Scand.* 2005;183(1):43–58.
- [30] Marín-Juez R, Díaz M, Morata J, Planas JV. Mechanisms Regulating GLUT4 Transcription in Skeletal Muscle Cells Are Highly Conserved across Vertebrates. *PLoS ONE.* 2013;8(11):e80628.
- [31] Capilla E, Díaz M, Albalat A, Navarro I, Pessin JE, Keller K, et al. Functional characterization of an insulin-responsive glucose transporter (GLUT4) from fish adipose tissue. *Am J Physiol Endocrinol Metab.* 2004;287(2):E348–57.
- [32] Díaz M, Antonescu CN, Capilla E, Klip A, Planas JV. Fish glucose transporter (GLUT)-4 differs from rat GLUT4 in its traffic characteristics but can translocate to

- the cell surface in response to insulin in skeletal muscle cells. *Endocrinology*. 2007;148(11):5248–57.
- [33] Seatter MJ, la Rue De SA, Porter LM, Gould GW. QLS motif in transmembrane helix VII of the glucose transporter family interacts with the C-1 position of D-glucose and is involved in substrate selection at the exofacial binding site. *Biochemistry*. 1998;37(5):1322–6.
- [34] Wellner M, Monden I, Keller K. From triple cysteine mutants to the cysteine-less glucose transporter GLUT1: a functional analysis. *FEBS Lett*. 1995;370(1-2):19–22.
- [35] Doege H, Schurmann A, Ohnimus H, Monser V, Holman GD, Joost HG. Serine-294 and threonine-295 in the exofacial loop domain between helices 7 and 8 of glucose transporters (GLUT) are involved in the conformational alterations during the transport process. *Biochem J*. 1998;329 (Pt 2):289–93.
- [36] Garippa RJ, Judge TW, James DE, McGraw TE. The amino terminus of GLUT4 functions as an internalization motif but not an intracellular retention signal when substituted for the transferrin receptor cytoplasmic domain. *J Cell Biol*. 1994;124(5):705–15.
- [37] Blot V, McGraw TE. Molecular mechanisms controlling GLUT4 intracellular retention. *Mol Biol Cell*. 2008;19(8):3477–87.
- [38] Martinez-Arca S, Lalioti VS, Sandoval IV. Intracellular targeting and retention of the glucose transporter GLUT4 by the perinuclear storage compartment involves distinct carboxyl-tail motifs. *J Cell Sci*. 2000;113 (Pt 10):1705–15.
- [39] Pessin JE, Thurmond DC, Elmendorf JS, Coker KJ, Okada S. Molecular basis of insulin-stimulated GLUT4 vesicle trafficking. Location! Location! Location! *J Biol Chem*. 1999;274(5):2593–6.
- [40] Capilla E, Suzuki N, Pessin JE, Hou JC. The glucose transporter 4 FQQI motif is necessary for Akt substrate of 160-kilodalton-dependent plasma membrane translocation but not Golgi-localized (gamma)-ear-containing Arf-binding protein-dependent entry into the insulin-responsive storage compartment. *Mol Endocrinol*. 2007;21(12):3087–99.
- [41] Al-Hasani H, Kunamneni RK, Dawson K, Hinck CS, Müller-Wieland D, Cushman SW. Roles of the N- and C-termini of GLUT4 in endocytosis. *J Cell Sci*. 2002;115(Pt 1):131–40.
- [42] Gould GW, Lienhard GE. Expression of a functional glucose transporter in *Xenopus* oocytes. *Biochemistry*. 1989;28(24):9447–52.
- [43] Gould GW, Thomas HM, Jess TJ, Bell GI. Expression of human glucose transporters in *Xenopus* oocytes: kinetic characterization and substrate specificities of the erythrocyte, liver, and brain isoforms. *Biochemistry*. 1991;30(21):5139–45.

- [44] Nishimura H, Pallardo FV, Seidner GA, Vannucci S, Simpson IA, Birnbaum MJ. Kinetics of GLUT1 and GLUT4 glucose transporters expressed in *Xenopus* oocytes. *J Biol Chem*. 1993;268(12):8514–20.
- [45] Teerijoki H, Krasnov A, Pitkanen TI, Mölsä H. Cloning and characterization of glucose transporter in teleost fish rainbow trout (*Oncorhynchus mykiss*). *Biochim Biophys Acta*. 2000;1494(3):290–4.
- [46] Soengas J, Moon T. Uptake and metabolism of glucose, alanine and lactate by red blood cells of the American eel *Anguilla rostrata*. *J Exp Biol*. 1995;198(Pt 4):877–88.
- [47] Basketter DA, Widdas WF. Competitive inhibition of hexose transfer in human erythrocytes by Cytochalasin B. *J Physiol*. 1977;265(1):39P–40P.
- [48] Basketter DA, Widdas WF. Asymmetry of the hexose transfer system in human erythrocytes. Comparison of the effects of cytochalasin B, phloretin and maltose as competitive inhibitors. *J Physiol*. 1978;278:389–401.
- [49] Deves R, Krupka RM. Cytochalasin B and the kinetics of inhibition of biological transport: a case of asymmetric binding to the glucose carrier. *Biochim Biophys Acta*. 1978;510(2):339–48.
- [50] Tiihonen K, Nikinmaa M, Lappivaara J. Glucose transport in carp erythrocytes: individual variation and effects of osmotic swelling, extracellular pH and catecholamines. *J Exp Biol*. 1995;198(Pt 2):577–83.
- [51] Tse CM, Young JD. Glucose transport in fish erythrocytes: variable cytochalasin-B-sensitive hexose transport activity in the common eel (*Anguilla japonica*) and transport deficiency in the paddyfield eel (*Monopterus albus*) and rainbow trout (*Salmo gairdneri*). *J Exp Biol*. 1990;148:367–83.
- [52] Young JD, Yao SYM, Tse CM, Davies A, Baldwin SA. Functional and Molecular Characteristics of a Primitive Vertebrate Glucose-Transporter-Studies of Glucose-Transport by Erythrocytes from the Pacific Hagfish (*Eptatretus Stouti*). *J Exp Biol*. 1994;186:23–41.
- [53] Murata H, Hruz PW, Mueckler M. The mechanism of insulin resistance caused by HIV protease inhibitor therapy. *J Biol Chem*. 2000;275(27):20251–4.
- [54] Murata H, Hruz PW, Mueckler M. Indinavir inhibits the glucose transporter isoform GLUT4 at physiologic concentrations. *AIDS (London, England)*. 2002;16(6):859–63.
- [55] Rudich A, Klip A. Push/pull mechanisms of GLUT4 traffic in muscle cells. *Acta Physiol Scand*. 2003;178(4):297–308.
- [56] Hall JR, Short CE, Driedzic WR. Sequence of Atlantic cod (*Gadus morhua*) GLUT4, GLUT2 and GPDH: Developmental stage expression, tissue expression and relationship to starvation-induced changes in blood glucose. *J Exp Biol*. 2006;209(Pt 22):4490–502.

- [57] Panserat S, Skiba-Cassy S, Seiliez I, Lansard M, Plagnes-Juan E, Vachot C, et al. Metformin improves postprandial glucose homeostasis in rainbow trout fed dietary carbohydrates: a link with the induction of hepatic lipogenic capacities? *Am J Physiol Regul Integr Comp Physiol*. 2009;297(3):R707–15.
- [58] McGowan KM, Long SD, Pekala PH. Glucose transporter gene expression: regulation of transcription and mRNA stability. *Pharmac Ther*. 1995;66(3):465–505.
- [59] Díaz M, Vraskou Y, Gutiérrez J, Planas JV. Expression of rainbow trout glucose transporters GLUT1 and GLUT4 during in vitro muscle cell differentiation and regulation by insulin and IGF-I. *Am J Physiol Regul Integr Comp Physiol*. 2009;296(3):R794–800.
- [60] Capilla E, Díaz M, Gutiérrez J, Planas JV. Physiological regulation of the expression of a GLUT4 homolog in fish skeletal muscle. *Am J Physiol Endocrinol Metab*. 2002;283(1):E44–9.
- [61] Neuffer PD, Carey JO, Dohm GL. Transcriptional regulation of the gene for glucose transporter GLUT4 in skeletal muscle. Effects of diabetes and fasting. *J Biol Chem*. 1993;268(19):13824–9.
- [62] MacLean PS, Zheng D, Jones JP, Olson AL, Dohm GL. Exercise-induced transcription of the muscle glucose transporter (GLUT 4) gene. *Biochem Biophys Res Comm*. 2002;292(2):409–14.
- [63] Jorgensen SB, Richter EA, Wojtaszewski JFP. Role of AMPK in skeletal muscle metabolic regulation and adaptation in relation to exercise. *J Physiol*. 2006;574(Pt 1):17–31.
- [64] Felip O, Ibarz A, Fernández-Borràs J, Beltrán M, Martín-Pérez M, Planas JV, et al. Tracing metabolic routes of dietary carbohydrate and protein in rainbow trout (*Oncorhynchus mykiss*) using stable isotopes (^{13}C]starch and ^{15}N]protein): effects of gelatinisation of starches and sustained swimming. *Br J Nutr*. 2012;107(6):834–44.
- [65] Magnoni LJ, Crespo D, Ibarz A, Blasco J, Fernández-Borràs J, Planas JV. Effects of sustained swimming on the red and white muscle transcriptome of rainbow trout (*Oncorhynchus mykiss*) fed a carbohydrate-rich diet. *Comp Biochem Physiol A Mol Integr Physiol*. 2013;166(3):1–12.
- [66] Magnoni LJ, Vraskou Y, Palstra AP, Planas JV. AMP-activated protein kinase plays an important evolutionary conserved role in the regulation of glucose metabolism in fish skeletal muscle cells. *PLoS ONE*. 2012;7(2):e31219.
- [67] Girón MD, Sevillano N, Vargas AM, Domínguez J, Guinovart JJ, Salto R. The glucose-lowering agent sodium tungstate increases the levels and translocation of GLUT4 in L6 myotubes through a mechanism associated with ERK1/2 and MEF2D. *Diabetologia*. 2008;51(7):1285–95.
- [68] Cooke DW, Lane MD. The transcription factor nuclear factor I mediates repression of the GLUT4 promoter by insulin. *J Biol Chem*. 1999;274(18):12917–24.

- [69] Hallakou S, Doare L, Foufelle F, Kergoat M, Guerre-Millo M, Berthault MF, et al. Pioglitazone induces in vivo adipocyte differentiation in the obese Zucker fa/fa rat. *Diabetes*. 1997;46(9):1393–9.
- [70] Díaz M, Capilla E, Planas JV. Physiological regulation of glucose transporter (GLUT4) protein content in brown trout (*Salmo trutta*) skeletal muscle. *J Exp Biol*. 2007;210(Pt 13):2346–51.
- [71] Dugani CB, Klip A. Glucose transporter 4: cycling, compartments and controversies. *EMBO reports*. 2005;6(12):1137–42.
- [72] Vraskou Y, Roher N, Díaz M, Antonescu CN, Mackenzie SA, Planas JV. Direct involvement of tumor necrosis factor- α in the regulation of glucose uptake in rainbow trout muscle cells. *Am J Physiol Regul Integr Comp Physiol*. 2011;300(3):R716–23.
- [73] Watson RT, Kanzaki M, Pessin JE. Regulated membrane trafficking of the insulin-responsive glucose transporter 4 in adipocytes. *Endocr Rev*. 2004;25(2):177–204.
- [74] Karylowski O, Zeigerer A, Cohen A, McGraw TE. GLUT4 is retained by an intracellular cycle of vesicle formation and fusion with endosomes. *Mol Biol Cell*. 2004;15(2):870–82.
- [75] Shewan AM, van Dam EM, Martin S, Luen TB, Hong W, Bryant NJ, et al. GLUT4 recycles via a trans-Golgi network (TGN) subdomain enriched in Syntaxins 6 and 16 but not TGN38: involvement of an acidic targeting motif. *Mol Biol Cell*. 2003;14(3):973–86.
- [76] Malide D, Dwyer NK, Blanchette-Mackie EJ, Cushman SW. Immunocytochemical evidence that GLUT4 resides in a specialized translocation post-endosomal VAMP2-positive compartment in rat adipose cells in the absence of insulin. *J Histochem Cytochem*. 1997;45(8):1083–96.
- [77] Martin OJ, Lee A, McGraw TE. GLUT4 distribution between the plasma membrane and the intracellular compartments is maintained by an insulin-modulated bipartite dynamic mechanism. *J Biol Chem*. 2006;281(1):484–90.
- [78] Satoh S, Nishimura H, Clark AE, Kozka IJ, Vannucci SJ, Simpson IA, et al. Use of bis-mannose photolabel to elucidate insulin-regulated GLUT4 subcellular trafficking kinetics in rat adipose cells. Evidence that exocytosis is a critical site of hormone action. *J Biol Chem*. 1993;268(24):17820–9.
- [79] Capilla E, Díaz M, Hou JC, Planas JV, Pessin JE. High basal cell surface levels of fish GLUT4 are related to reduced sensitivity of insulin-induced translocation toward GGA and AS160 inhibition in adipocytes. *Am J Physiol Endocrinol Metab*. 2010;298(2):E329–36.

- [80] Slot JW, Geuze HJ, Gigengack S, Lienhard GE, James DE. Immuno-localization of the insulin regulatable glucose transporter in brown adipose tissue of the rat. *J Cell Biol.* 1991;113(1):123–35.
- [81] Li LV, Kandrор KV. Golgi-localized, gamma-ear-containing, Arf-binding protein adaptors mediate insulin-responsive trafficking of glucose transporter 4 in 3T3-L1 adipocytes. *Mol Endocrinol.* 2005;19(8):2145–53.
- [82] Shi J, Kandrор KV. Sortilin is essential and sufficient for the formation of GLUT4 storage vesicles in 3T3-L1 adipocytes. *Dev Cell.* 2005;9(1):99–108.
- [83] Jordens I, Molle D, Xiong W, Keller SR, McGraw TE. Insulin-regulated aminopeptidase is a key regulator of GLUT4 trafficking by controlling the sorting of GLUT4 from endosomes to specialized insulin-regulated vesicles. *Mol Biol Cell.* 2010;21(12):2034–44.
- [84] Yu C, Cresswell J, Löffler MG, Bogan JS. The glucose transporter 4-regulating protein TUG is essential for highly insulin-responsive glucose uptake in 3T3-L1 adipocytes. *J Biol Chem.* 2007;282(10):7710–22.
- [85] Khan AH, Capilla E, Hou JC, Watson RT, Smith JR, Pessin JE. Entry of newly synthesized GLUT4 into the insulin-responsive storage compartment is dependent upon both the amino terminus and the large cytoplasmic loop. *J Biol Chem.* 2004;279(36):37505–11.
- [86] Piper RC, Tai C, Kulesza P, Pang S, Warnock D, Baenziger J, et al. GLUT-4 NH2 terminus contains a phenylalanine-based targeting motif that regulates intracellular sequestration. *J Cell Biol.* 1993;121(6):1221–32.
- [87] Piper RC, Tai C, Slot JW, Hahn CS, Rice CM, Huang H, et al. The efficient intracellular sequestration of the insulin-regulatable glucose transporter (GLUT-4) is conferred by the NH2 terminus. *J Cell Biol.* 1992;117(4):729–43.
- [88] Melvin DR, Marsh BJ, Walmsley AR, James DE, Gould GW. Analysis of amino and carboxy terminal GLUT-4 targeting motifs in 3T3-L1 adipocytes using an endosomal ablation technique. *Biochemistry.* 1999;38(5):1456–62.
- [89] Khan AH, Capilla E, Hou JC, Watson RT, Smith JR, Pessin JE. Entry of newly synthesized GLUT4 into the insulin-responsive storage compartment is dependent upon both the amino terminus and the large cytoplasmic loop. *J Biol Chem.* 2004;279(36):37505–11.
- [90] Ceresa BP, Kao AW, Santeler SR, Pessin JE. Inhibition of clathrin-mediated endocytosis selectively attenuates specific insulin receptor signal transduction pathways. *Mol Cell Biol.* 1998;18(7):3862–70.
- [91] Kao AW, Ceresa BP, Santeler SR, Pessin JE. Expression of a dominant interfering dynamin mutant in 3T3L1 adipocytes inhibits GLUT4 endocytosis without affecting insulin signaling. *J Biol Chem.* 1998;273(39):25450–7.

- [92] Shibata H, Suzuki Y, Omata W, Tanaka S, Kojima I. Dissection of GLUT4 recycling pathway into exocytosis and endocytosis in rat adipocytes. Evidence that GTP-binding proteins are involved in both processes. *J Biol Chem*. 1995;270(19):11489–95.
- [93] Hou JC, Pessin JE. Ins (endocytosis) and outs (exocytosis) of GLUT4 trafficking. *Curr Opin Cell Biol*. 2007;19(4):466–73.
- [94] Yang J, Clarke JF, Ester CJ, Young PW, Kasuga M, Holman GD. Phosphatidylinositol 3-kinase acts at an intracellular membrane site to enhance GLUT4 exocytosis in 3T3-L1 cells. *Biochem J*. 1996;313 (Pt 1):125–31.
- [95] Shepherd PR, Withers DJ, Siddle K. Phosphoinositide 3-kinase: the key switch mechanism in insulin signalling. *Biochem J*. 1998;333 (Pt 3):471–90.
- [96] Czech MP, Corvera S. Signaling mechanisms that regulate glucose transport. *J Biol Chem*. 1999;274(4):1865–8.
- [97] Baumann CA, Ribon V, Kanzaki M, Thurmond DC, Mora S, Shigematsu S, et al. CAP defines a second signalling pathway required for insulin-stimulated glucose transport. *Nature*. 2000;407(6801):202–7.
- [98] JeBailey L, Rudich A, Huang X, Di Ciano-Oliveira C, Kapus A, Klip A. Skeletal muscle cells and adipocytes differ in their reliance on TC10 and Rac for insulin-induced actin remodeling. *Mol Endocrinol*. 2004;18(2):359–72.
- [99] Patel N, Rudich A, Khayat ZA, Garg R, Klip A. Intracellular segregation of phosphatidylinositol-3,4,5-trisphosphate by insulin-dependent actin remodeling in L6 skeletal muscle cells. *Mol Cell Biol*. 2003;23(13):4611–26.
- [100] Kane S, Sano H, Liu SC, Asara JM, Lane WS, Garner CC, et al. A method to identify serine kinase substrates. Akt phosphorylates a novel adipocyte protein with a Rab GTPase-activating protein (GAP) domain. *J Biol Chem*. 2002;277(25):22115–8.
- [101] Sano H, Kane S, Sano E, Miinea CP, Asara JM, Lane WS, et al. Insulin-stimulated phosphorylation of a Rab GTPase-activating protein regulates GLUT4 translocation. *J Biol Chem*. 2003;278(17):14599–602.
- [102] Sakamoto K, Holman GD. Emerging role for AS160/TBC1D4 and TBC1D1 in the regulation of GLUT4 traffic. *Am J Physiol Endocrinol Metab*. 2008;295(1):E29–37.
- [103] Ishikura S, Bilan PJ, Klip A. Rabs 8A and 14 are targets of the insulin-regulated Rab-GAP AS160 regulating GLUT4 traffic in muscle cells. *Biochem Biophys Res Comm*. 2007;353(4):1074–9.
- [104] Ishikura S, Koshkina A, Klip A. Small G proteins in insulin action: Rab and Rho families at the crossroads of signal transduction and GLUT4 vesicle traffic. *Acta Physiol (Oxf)*. 2008;192(1):61–74.

- [105] Sano H, Eiguez L, Teruel MN, Fukuda M, Chuang TD, Chavez JA, et al. Rab10, a target of the AS160 Rab GAP, is required for insulin-stimulated translocation of GLUT4 to the adipocyte plasma membrane. *Cell Metab.* 2007;5(4):293–303.
- [106] Sadacca LA, Bruno J, Wen J, Xiong W, McGraw TE. Specialized sorting of GLUT4 and its recruitment to the cell surface are independently regulated by distinct Rabs. *Mol Biol Cell.* 2013;24(16):2544–57.
- [107] Eiguez L, Lee A, Chavez JA, Miinea CP, Kane S, Lienhard GE, et al. Full intracellular retention of GLUT4 requires AS160 Rab GTPase activating protein. *Cell Metab.* 2005;2(4):263–72.
- [108] Zeigerer A, McBrayer MK, McGraw TE. Insulin stimulation of GLUT4 exocytosis, but not its inhibition of endocytosis, is dependent on RabGAP AS160. *Mol Biol Cell.* 2004;15(10):4406–15.
- [109] Planas JV, Méndez E, Baños N, Capilla E, Castillo J, Navarro I, et al. Fish insulin, IGF-I and IGF-II receptors: A phylogenetic approach. *Am Zool.* 2000;40(2):223–33.

