

Computational Study of the Stability of Pyrrolidine-Derived Iminium Ions: Exchange Equilibria between Iminium Ions and Carbonyl Compounds

Anna M. Costa,* Víctor Cascales, Alejandro Castro-Alvarez, and Jaume Vilarrasa*

Cite This: *ACS Omega* 2022, 7, 18247–18258

Read Online

ACCESS |



Metrics & More



Article Recommendations



Supporting Information

ABSTRACT: The tendency of carbonyl compounds to form iminium ions by reaction with pyrrolidine or chiral pyrrolidine derivatives (in other words, the relative stability to hydrolysis of these iminium ions) has been computationally examined, mainly using the M06-2X/6-311+G(d,p) method. We have thus obtained the equilibrium positions for $R-CH=O + CH_2=CH-CH=N^+R_2^* \rightarrow R-CH=N^+R_2^* + CH_2=CH-CH=O$ reactions and for related exchanges. In these exchanges, there is a transfer of a secondary amine between two carbonyl compounds. Their relative energies may be used to predict which iminium species can be predominantly formed when two or more carbonyl groups are present in a reaction medium. In the catalytic Michael additions of nucleophiles to iminium ions arising from conjugated enals, dienals, and trienals, if the formation of the new Nu–C bond is favorable, the chances of amino-catalyzed reactions to efficiently proceed, with high conversions, depend on the calculated energy values for these exchange equilibria, where the iminium tetrafluoroborates of the adducts (final iminium intermediates) must be more prone to hydrolysis than the initial iminium tetrafluoroborates. The density functional theory (DFT) calculations indicate that the MacMillan catalysts and related oxazolidinones are especially suitable in this regard.

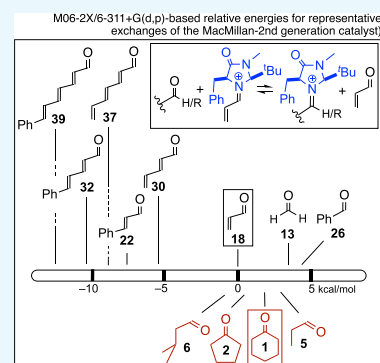

INTRODUCTION

Iminium ions are involved as intermediates in the secondary amine-catalyzed (amino-catalyzed) reactions¹ of conjugated carbonyl compounds with nucleophiles, in asymmetric Michael-type reactions, such as those shown in Scheme 1. Catalytic amounts of an organic or inorganic acid (HA), to produce the corresponding iminium salts ($Ar-CH=CH-CH=N^+RR^* A^-$, in Scheme 1), are generally required.

Scheme 1. Organocatalytic Reaction of Enals, through Eniminium Ions, with Nucleophiles

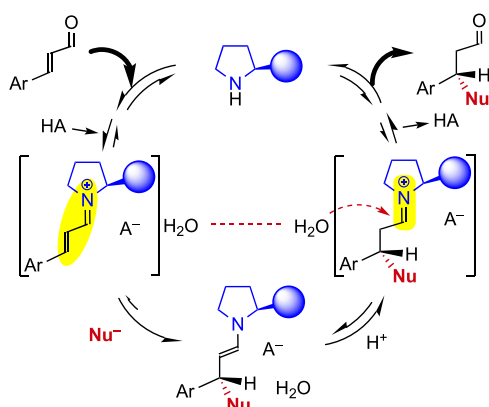

In this context, we were interested in comparing the tendency of different carbonyl compounds to form iminium ions and, consequently, to foresee which iminium salt would be predominantly formed when a secondary amine is added in catalytic amounts to advanced fragments/synthons/chiro blocks containing two or more carbonyl groups or when there are two carbonyl compounds in the reaction medium. This was the first objective of our work. We focused our attention on the evaluation of the relative stability of a long series of iminium ions arising from pyrrolidine, chiral pyrrolidines, and chiral imidazolidin-4-ones (MacMillan catalysts,² among which we chose the derivatives called here McM1 and McM2). There are interesting precedents that include density functional theory (DFT) calculations of iminium salts of some secondary amines, mainly of the Jørgensen–Hayashi (JH) catalyst³ and the MacMillan catalysts,² or regarding aspects of organocatalytic reactions,⁴ but here we report for the first time a comprehensive comparison of series of iminium ions from various carbonyl compounds and secondary amines. In fact, by exchange of

Received: December 12, 2021

Accepted: May 11, 2022

Published: May 26, 2022

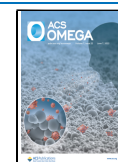

pyrrolidines between two different carbonyl compounds, such as in Scheme 2, we have ranked iminium ions based on their relative stability.

Scheme 2. Main Species and Equilibria Calculated

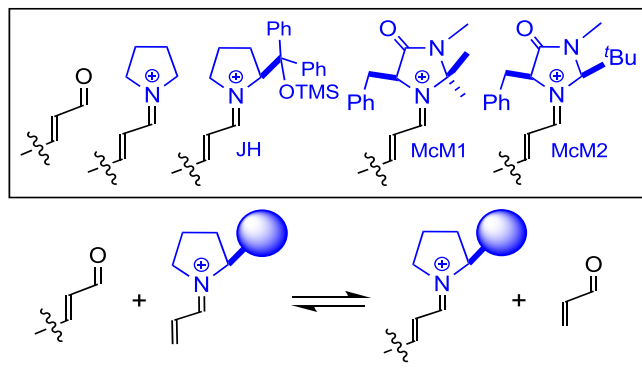

Thus, (1) after checking the effect of conjugation on the relative total energies (E), H° , and G° of simple but representative eniminium, dieniminium, and trieniminium ions (from enals, dienals, and trienals), we compared (2) the energies of formation and hydrolysis of pyrrolidine-derived iminium ions for a series of aldehydes and ketones, as well as (3) the effect of polar media and (4) the effect of the anion/counterion (tetrafluoroborate ion). After studies with model compounds from 2-*tert*-butylpyrrolidine, which are included in the Supporting Information, we examined the formation and hydrolysis of: (5) JH-related iminium ions and (6) MacMillan-related iminium ions.

As an application of these studies, we then calculated how much shifted to the right are the possible exchanges between starting eniminium ions and 3'-substituted iminium ions (the iminium ions of the corresponding Michael adducts). This is the second objective of this work: to gain insight into why asymmetric Michael additions with some catalysts are more favorable than with others.

We will not deal here with the stereoselectivity of the overall reaction, which, as it is well known¹ from the beginning of the aminocatalysis, depends on the size and electronic features of the substituent on C2, which controls the main configuration and conformation of the eniminium intermediate arising from aldehydes (as drawn in Scheme 1) and forces the attack of the nucleophile through the opposite face of the almost planar conjugated system. Moreover, even though iminium ions are also implied as intermediates in enamine-involving (highest occupied molecular orbital (HOMO)-raising) organocatalytic reactions, at least in the acid-catalyzed hydrolysis step of the resulting enamine,⁵ we will not include them in the present study. We will not examine either open-shell species such as radical cations generated by means of oxidizing agents and/or by photocatalysis, which give rise to different reactivity patterns.⁶ We hope to be able to computationally revise and review some of these hot topics in the future.

RESULTS AND DISCUSSION

Effect of Conjugation on the Stability of Representative Pyrrolidine-Derived Iminium Ions. First, we evaluated the effect of conjugation of the iminium ions with additional double bonds (Scheme 3). The values of ΔE in Scheme 3 are those arising from the sum and subtraction of the individual

Scheme 3. Exchange of Pyrrolidine between Enals, Dienals, and Trienals and Their Iminium Ions^a

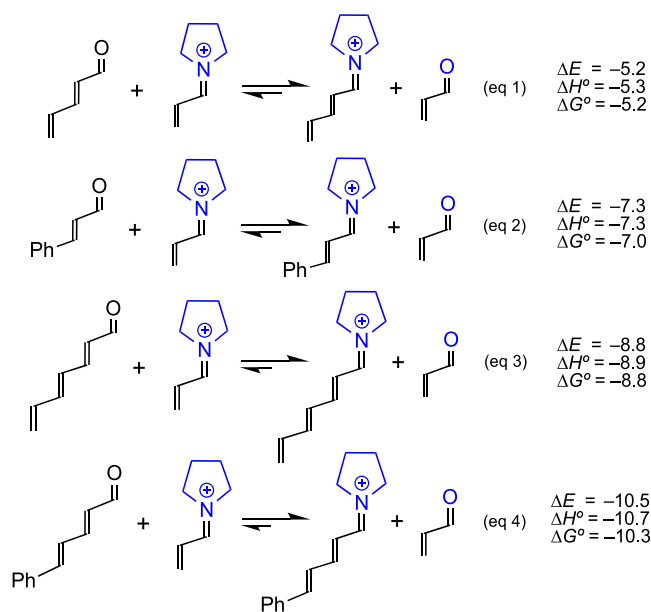

^aReaction energies in kcal/mol.

total energies, as calculated by the M06-2X/6-311+G(d,p) DFT method,⁷ which are given in the Supporting Information. Scheme 3 shows that an additional double bond means a relative stabilization of nearly 3.5 kcal/mol (by comparing eq 1 with eq 3, as well as eq 2 with eq 4). The comparison of eqs 1 and 4 suggests that the relative stabilization caused by an additional Ph ring is around 5 kcal/mol. Further calculations with MP2/6-31G(d), SCS-MP2/6-31G(d), MP2/6-311+G(d,p), and SCS-MP2/6-311+G(d,p)⁸ are also collected in the Supporting Information; these ΔE values are similar. As these initial calculations suggest, throughout this report, only the M06-2X/6-311+G(d,p) values will be compared in the main text, although other calculations were carried out at lower and higher levels of theory, to corroborate that the outcome was independent of the method used and that the results were reasonable and reliable.

From the frequency calculations at the M06-2X/6-311+G(d,p) level, without scaling factors, we obtained the corresponding ΔH° and ΔG° values. See Scheme 3. As expected for the type of equilibria involved, they are very close to the ΔE values. Thus, for the sake of simplicity and for saving a lot of computer time (when large molecules are studied), we have not calculated the ΔG° values for the hundreds of equilibria examined in this work but we did it for many representative cases, with and without scaling factors (see below). Comparisons of ΔE values are not subject to the approximations associated with the entropy calculations.

Formation and Hydrolysis of Iminium Ions from Pyrrolidine and a Series of Carbonyl Compounds. After the preliminary study disclosed in Scheme 3, we were ready to compare a long series of carbonyl compounds (all of the low-energy conformers of each carbonyl compound) and the corresponding series of pyrrolidine-derived iminium ions⁹ (all of the low-energy conformers as well) were then calculated at the M06-2X/6-311+G(d,p) level (Figure 1). The first 12 pairs are enolizable ketones or aldehydes and their corresponding iminium ions: cyclohexanone, 1; cyclopentanone, 2; acetone/

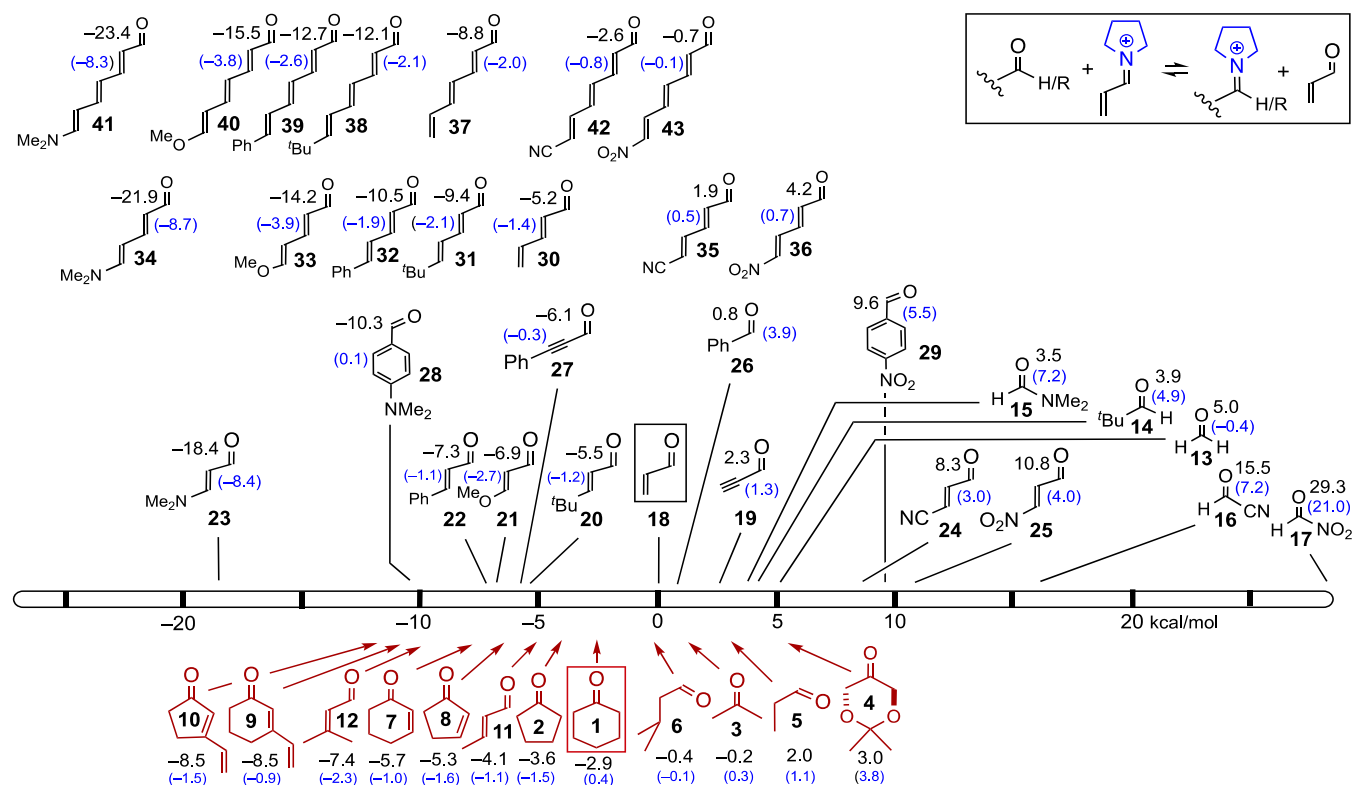

Figure 1. Relative energies for equilibria between pyrrolidine-derived iminium ions and carbonyl compounds.

2-propanone, 3; 2,2-dimethyl-1,3-dioxo-4-cyclohexanone, 4; propanal, 5, 3-methylbutanal/isovaleraldehyde, 6, and conjugated carbonyl compounds, from 2-cyclohexenone, 7, to 3-methyl-2-butenal, 12. These compounds are depicted below the abscissa values, in red. The other pairs are nonenolizable (methanal/formaldehyde, 13, and its monosubstituted derivatives 14–17, propynal, 19, benzaldehyde, 26, etc.) or noneasily enolizable species (including propenal/acrolein, 18, and its derivatives 20–25, dienals 30–36, and trienals 37–43). The resulting total energy values, in au or Hartrees, at 0 K, of the lowest-energy conformers were used to estimate the energies for the exchange or metathesis reactions shown in Figure 1. In many cases, also as mentioned above, we confirmed that these relative ΔE values are maintained using other methods.

In Figure 1, just like in Schemes 2 and 3, we have chosen propenal (18, acrolein, the simpler enal) and its iminium ion (*N*-propenylidenepyrrolidinium ion, $\text{im}^+\cdot\mathbf{18}$) as the reference pair. All of the pairs made of carbonyl compounds and their respective iminium ions have been compared to this simple pair.

We chose the cyclohexanone and its pair ($\mathbf{1}/\text{im}^+\cdot\mathbf{1}$) as a second reference, bearing in mind that cyclohexanone has been largely used in aminocatalysis as a substrate and that it is an appropriate model for the easily enolizable carbonyl compounds. Anyway, what matters is the relative position of each pair in the scale. Thus, in Figure 1, the more stable iminium ions are those of the carbonyl compounds on the left and the less stable cations are those of the carbonyl compounds on the right.

Electron-donating groups (EDGs, which can likely stabilize much more the cationic species than the neutral carbonyl compounds) shift the corresponding pair to the left, whereas the electron-withdrawing groups (EWGs) shift the correspond-

ing pair to the right. This is not surprising: it was qualitatively expected, on the basis of the classical resonance rules, but reliable DFT calculations allow us to predict the energy differences among the various examples.

To summarize, the carbonyl compounds located on the left-hand side in Figure 1 are those more prone to give the corresponding iminium salts, that is, these iminium ions (im^+) should show a lower tendency to be hydrolyzed. For example, if the $\mathbf{1}/\text{im}^+\cdot\mathbf{1}$ pair is compared to the 2-cyclohexenone pair ($\mathbf{7}/\text{im}^+\cdot\mathbf{7}$) and to the 3-vinyl-2-cyclohexenone pair ($\mathbf{9}/\text{im}^+\cdot\mathbf{9}$), the conjugation with one double bond and with two double bonds progressively increases the relative stability of the corresponding iminium ions. On the contrary, the carbonyl compounds located on the right side of Figure 1 should form their iminium ions with more difficulty. The cases of compounds 16 and 17 deserve a comment. Even though it is plausible that the attempts to prepare the corresponding iminium ions are unsuccessful, as these species can decompose with loss of HCN and HNO₂, respectively, we have included them to evaluate “theoretically” the effect of strong EWGs in a close vicinity to the CO group. The results are expected: among the 43 species examined, they are the ones more shifted to the right in Figure 1.

Apart from the ΔG° values for the conjugated aldehydes shown in Scheme 3, we calculated those corresponding to the exchanges of cyclohexanone (the $\mathbf{1}/\text{im}^+\cdot\mathbf{1}$ pair), propanal ($\mathbf{5}/\text{im}^+\cdot\mathbf{5}$), formaldehyde ($\mathbf{13}/\text{im}^+\cdot\mathbf{13}$), and benzaldehyde ($\mathbf{26}/\text{im}^+\cdot\mathbf{26}$) with propenal ($\mathbf{18}/\text{im}^+\cdot\mathbf{18}$). These ΔG° values were calculated without scaling factor and with the recommended scaling factor of 0.970 for thermochemistry calculations with M06-2X/6-311+G(d,p).¹⁰ The results were identical among them and almost identical or very close to the ΔE values (see the Supporting Information).

Effect of Polar Media. The results shown in Figure 1 are probably exacerbated by the fact that the calculations involved isolated cations (so-called calculations in the gas phase or in vacuo, depending on the software programs). Thus, we recalculated the pairs in polar solvents, with the implicit solvent model conductor-like polarizable continuum model (CPCM) (single-point calculations, see the Computational Methods section). The corresponding ΔE values in water are shown in Figure 1 within parentheses (in blue). The results (ΔE) were practically identical (± 0.1 – 0.2 kcal/mol) when the structures were reoptimized in other highly polar solvents, although of lower dielectric constants than water, such as dimethyl sulfoxide (DMSO) or dimethylformamide (DMF). Calculations with the SMD model (see the Computational Methods section) were also carried out with 12 relevant pairs. The results were parallel to those obtained with the CPCM model (see the Supporting Information).

The ordering of stability of iminium ions in water gives an idea of how exothermic these exchanges would be in other very polar solvents. Experimentally, of course, an aqueous medium may be detrimental, as the initial iminium species would not be generated (unless two layers are formed, with the substrates and catalysts contained in or constituting the hydrophobic phase, which is quite usual dealing with organic substrates). In contrast, a trace of water in the organic solvent or layer is required to catalyze the exchange.¹¹

When the results in water are compared, all of the pairs are found between -8.7 and $+21.0$ kcal/mol, while the range was between -23.4 and $+29.3$ kcal/mol in the gas phase. There is an expected leveling effect or compensation. DFT calculations indicate how much large it is. The polar solvents relatively stabilize less those $C=N^+RR'$ groups that are conjugated to double bonds and EDGs. By contrast, the polar solvents relatively stabilize more those $C=N^+RR'$ groups bound to EWGs or those that have no other possibilities of stabilization. The polar media compensate the lack of stabilization of cations by charge delocalization, which is reasonable. In general, the order of the pairs is almost the same.

Furthermore, in Scheme 4, the effects of $CHCl_3$, DMF, and H_2O on the exchange equilibria are compared in the first column. The values in the gas phase and in water are coincident with those given in Figure 1 (although some deviations, usually of only around 0.1 kcal/mol, are noted, since in Scheme 4, the values in water come from geometries optimized in this medium). The leveling effect produced by the polarity of the solvent is clear.

Effect of the Counterion (Tetrafluoroborate Ion). In the few slightly polar organic solvents that can dissolve iminium salts, such as dichloromethane and chloroform, it is expected that the iminium ions will be associated with the corresponding anions, as ion pairs if these anions are non-nucleophilic. Thus, we calculated a few iminium tetrafluoroborates in $CHCl_3$, a selection of which is shown in Scheme 4 (second column values). For the sake of comparison, we also calculated the exchange energies between these salts in the gas phase, in DMF, and in water, although in very polar solvents at standard concentrations we assume that the ion pairs will be mainly dissociated.

The inclusion of BF_4^- reduces the energy values for the exchange equilibria shown in Scheme 4 (second column), compared to Scheme 3. For these examples, the effect of ion pairing is significant, which is understandable, but the present DFT calculations suggest that it is almost independent of the

Scheme 4. Exchange of Pyrrolidine between Enals, Dienals, and Trienals, and either Their Iminium Ions or Their Tetrafluoroborates^{a–f}

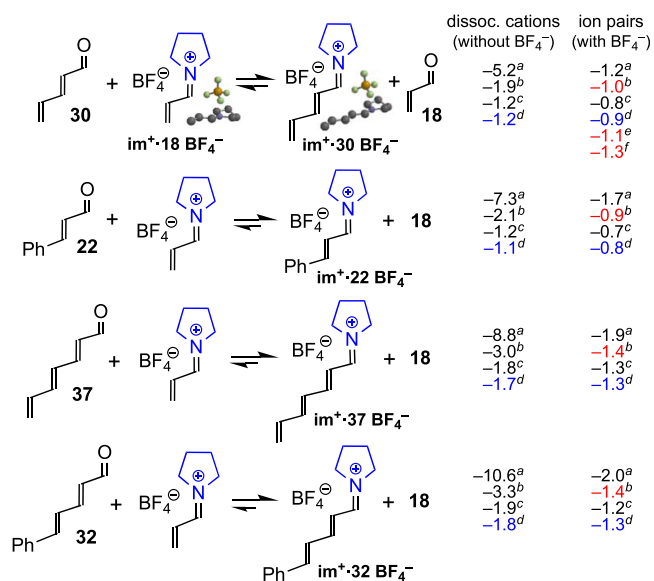

^aEnergy values in kcal/mol from M06-2X/6-311+G(d,p) in the gas phase. ^b ΔE values in kcal/mol from M06-2X/6-311+G(d,p)· $CHCl_3$ -CPCM. ^c ΔE values in kcal/mol from M06-2X/6-311+G(d,p)·DMF-CPCM. ^d ΔE values in kcal/mol from M06-2X/6-311+G(d,p)·w-CPCM. ^e ΔG° ($CHCl_3$ -CPCM-Gaussian 16), without scaling factor (sf = 1.000); with sf = 0.970 the ΔG° value is also -1.1 kcal/mol. ^f ΔG° ($CHCl_3$ -SMD), without scaling factor.

medium. In fact, the ΔE values are practically the same in the three solvents examined, to our initial surprise.

Again, the calculated ΔG° values, also for equilibria involving ion pairs (superscripts e and f in Scheme 4), do not practically differ from the ΔE values (see the first chemical equation, superscript b).

We also investigated the counterion effect on exchange equilibria where the difference relies on the electron-donating or electron-withdrawing features of the substituents, as in the example shown in Scheme 5 (bottom). When ion pairs are calculated, practically the same exchange energies are obtained in the gas phase, in $CHCl_3$, and in water. Almost the same outcome was obtained with TfO^- instead of BF_4^- (Supporting Information). All of these results are like those indicated in Scheme 4. This means that, once the counterion is introduced, the solvent polarity is unimportant. The compensation effect is maximum in the gas phase, going from the cations (-9.7 kcal/mol) to the ion pairs (-1.4 kcal/mol); the effect is small going from the “solvated” cation in water to the “ion pair” in water, which is also reasonable.

Besides the M06-2X calculations, we carried out some experiments. We prepared pyrrolidinium tetrafluoroborate from equimolar amounts of pyrrolidine and HBF_4/Et_2O in hexane. By the addition of cinnamaldehyde (3-phenylpropenal, 22), we obtained an iminium salt ($im^+22 BF_4^-$). The relevant signals of its 1H NMR spectrum in $CDCl_3$ are shown in Scheme 5 and the full spectrum is reproduced in the Supporting Information. Addition of commercially available (*E*)-3-(4-dimethylamino)phenylpropenal, 44, gave rise to a new species within 1 h. After 12 h, the equilibrium was established, where the new iminium salt ($im^+44 BF_4^-$) predominated. This fact was expected, due to the electron-

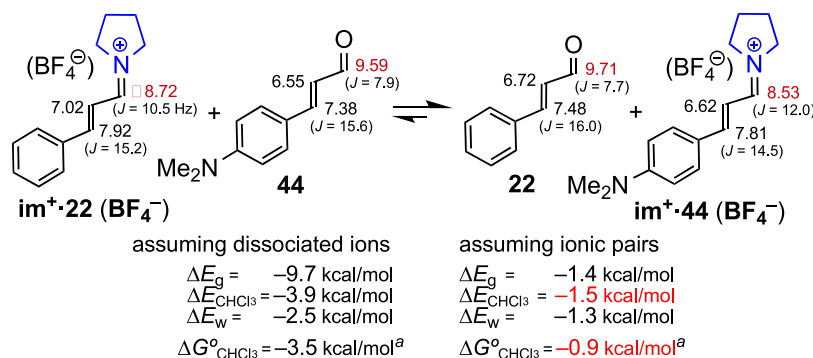
Scheme 5. Exchange of Pyrrolidine between 22 and 44. M06-2X Energies in Different Media and NMR Data in CDCl₃^a

^aFrom M06-2X/6-311+G(d,p)-CHCl₃-CPCM-Gaussian 16. Identical ΔG° values without scaling factor (and with the scaling factor equal to 0.970.¹⁰

donating features of the NMe₂ group, but it had to be confirmed: the experimental result qualitatively agrees with the calculations of ion pairs shown in Scheme 5.

In another experiment, we prepared im⁺•22 TfO⁻,^{9h} that is, the trifluoromethanesulfonate of im⁺•22, as a pure solid, from trimethylsilylpyrrolidine, 22, and trimethylsilyl triflate.⁹ After the addition of 44 (up to 1.5 equiv) nothing happened, but the addition of aqueous tetrahydrofuran (THF) to the NMR tube slowly produced the predicted exchange (see the Supporting Information).

All of these results on the relative stability of pyrrolidine-derived iminium ions may be considered preliminary. In fact, iminium ions from chiral pyrrolidines are the species that matter from the viewpoint of asymmetric organocatalysis. To avoid the calculation of a huge number of conformers for each species of interest, we first studied the simpler case of 2-*tert*-butylpyrrolidine. It is a model of chiral pyrrolidine with medium-to-large nonpolar group at position 2, which helped us to establish configurational and conformational aspects of 2-substituted iminium ions. For example, the *Z* iminium isomer of 2-*t*Bu derivative of im⁺•18 was found to be 2.1 kcal/mol above the “standard” *E* isomer (im⁺•18) in vacuo and 1.7 kcal/mol in water; the C3up-C4down conformer was 0.4 kcal/mol above the C3down-C4up conformer (0.5 kcal/mol in water). The ΔG° gaps were similar. Further details about this case (2-*t*Bu derivatives) are included in the Supporting Information.

Formation and Hydrolysis of JH-Derived Iminium Ions. We examined iminium ions arising from the Jørgensen–Hayashi catalyst (JH)^{4a–c,12} and a selection of unsaturated aldehydes and other carbonyl compounds. It is a complex case due to the huge number of possible conformers for each cation. Thus, we mainly focused our attention on the conjugated enals, dienals, and trienals (comparison of 22, 30, 32, 37, and 39 with 18) and the respective iminium ions. The outcome, as always based on the lowest-energy species found for each compound, is summarized in Figure 2.

The exchange energies for the conjugated enal/eninium pairs are close to the reference pair (18/JH•im⁺•18) and to each other, in comparison with Figure 1, as if the positive charge of the C=N⁺ moiety in the gas phase was partially compensated by the presence of the CPh₂(OTMS) group. The compensation is higher than with 2-*t*Bu (Supporting Information). The lowest-energy conformation of each of these iminium ions has the oxygen atom of the OTMS group pointing to the C=N⁺ moiety.

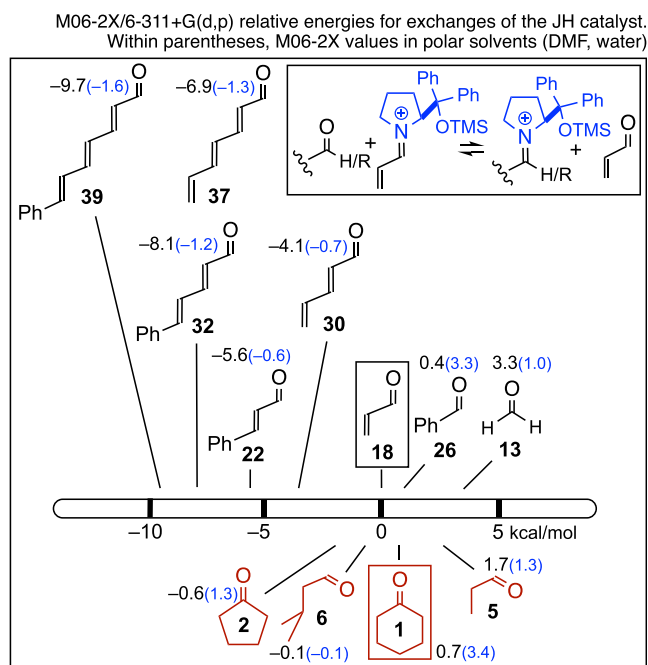
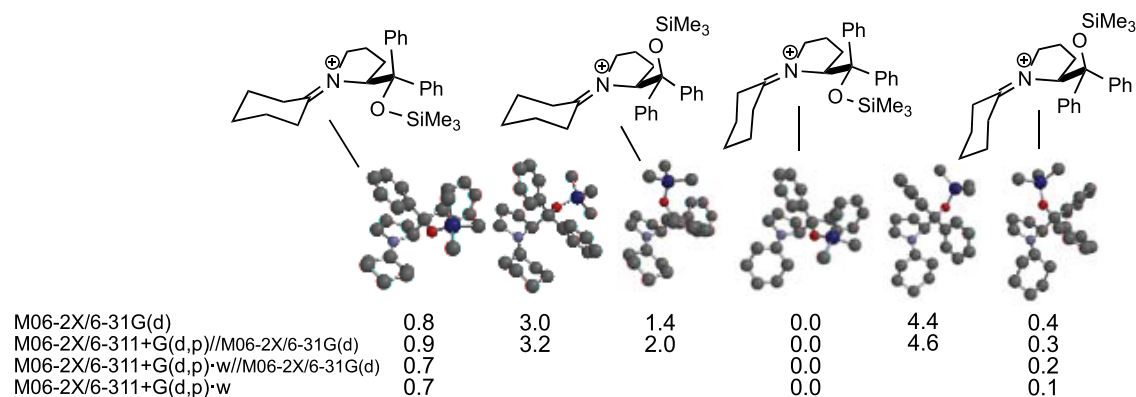

Figure 2. Relative energies in kcal/mol for the exchange equilibria between JH-derived iminium ions and carbonyl compounds.

Iminium ions from JH and ketones (JH•im⁺•1 and JH•im⁺•2) also move to the right in relation to Figure 1 (im⁺•1 and im⁺•2), but this can be explained by the steric hindrance between the additional CH₂ groups of these ketones (in relation to the aldehydes) and the substituent at C2. In fact, for the cyclohexanone derivative (JH•im⁺•1), the main conformer (relative energy 0.0) is the fourth of the six shown in Scheme 6, with the OTMS group above the C=N⁺ moiety, even in a very polar solvent. However, the conformer with the OTMS group over the pyrrolidine ring (see the sixth conformer), with C2 and C5 that also have a charge deficiency, is close in energy. In short, all of these electrostatic interactions likely play a role in the stability of these iminium ions.

Figure 2 also includes the effect of the polarity of the medium, which is again significant: in water (values in blue) the energies vary between -1.6 and +1.3 kcal/mol, whereas the range in the gas phase is between -9.7 and +3.3 kcal/mol. The values in blue are almost identical in DMF and DMSO. In fact, for the representative equilibria examined, the ΔE

Scheme 6. Main Conformers of JH-im⁺1, the Iminium Ion from the JH Catalyst and 1^a

^aRelative energies in kcal/mol.

differences between using these three polar solvents were minimal (less than 0.1 kcal/mol).

Formation and Hydrolysis of MacMillan Catalysts-Derived Iminium Ions. The chiral imidazolidinones developed by MacMillan and co-workers³ have enjoyed many useful applications as aminocatalysts, via iminium ions, and DFT calculations have been reported.^{4d,e,13} Figure 3 shows the relative energies for the formation of a representative selection of iminium ions.

There are no significant differences, in general, between one series and the other, probably because the steric hindrance between the substituted azolidine ring and enyl, dienyl, and trienyl chains are similar and, if compared to ketones, small.

It is worth noting that the values of ΔE for the pairs related to 39, 37, 32, 30, and 22, in relation to 18, are almost identical to those observed in Figure 1 (pyrrolidine derivatives) and larger than those shown in Figure 2. As indicated above, the interpretation is that substituent CPh₂(OTMS) on C2 stabilizes the C=N⁺ group so that the conjugation of this group with a triene or diene is less relevant. By contrast, with the MacMillan catalysts, the slightly stabilizing or compensating effect of the groups on C2 and C5 is countered by the CONMe group of these imidazolidinones.

The main conformers of the iminium ions from the first-generation MacMillan catalyst (Figure 3, top)^{4d} are different from those of the second generation. In this last series, the lowest-energy rotamers have the Ph of the benzyl group over the substituents on the N (Figure 3, bottom), avoiding or dodging the ^tBu group, with one exception. The exception is benzaldehyde, 26, since the Ph group of the PhCH=N⁺ moiety is close to the heterocyclic ring; the most stable conformer (by 0.5 kcal/mol at the M06-2X level) is predicted to be another rotamer of the benzyl group, with the Ph group out, thus avoiding the steric interaction between both phenyl groups (PhCH₂ and PhCH=).

To check the importance of the entropic factor in the McM2 series (that is, with quite crowded cations), we calculated the G^o values for the twelve pairs shown in Figure 3 (bottom) with the scaling factor used above. In general, the new figure (Figure S10) is essentially identical to Figure 3 (bottom). Small shifts of the cyclohexanone pair to the right and of the formaldehyde pair to the left are commented in the Supporting Information.

Application to the Exchanges between Conjugated Iminium Ions and Their Michael Adducts. When the addition of a nucleophile, such as cyanide ion, to conjugated

iminium intermediates¹⁴ takes place, a “competition” begins between the initial conjugated iminium salt and final nonconjugated (or, in general, less conjugated) iminium salts for the water molecules (see Scheme 1). If the first equilibrium step (dehydration) is more shifted to the left than the final equilibrium step (hydrolysis) to the right, the organocatalytic reaction will give low conversions: it will not reach completion even after several days. This simple but key idea is depicted in Scheme 7, where eq 3 = eq 1 + eq 2.

The argument is that efficient Michael-type aminocatalytic processes require that eq 3 is shifted to the right (and require suitable nucleophiles, but the nucleophilic addition to an organic cation is not usually problematic from the kinetic and thermodynamic viewpoints). Intuitively, the first equilibrium (eq 1) could be shifted to the right by a good dehydrating agent; such a dehydration reagent “can be” the iminium ion of the addition product (adduct), that is, the iminium ion depicted in eq 2. It does not matter if a moist organic solvent is used or if the water concentration in the organic layer of a biphasic system is low or high: what disfavors eq 1 favors eq 2, so eq 3 is in principle independent of the amount of water in the flask.

The subtraction of the two formation reactions, or of the two hydrolysis reactions, gives the equilibria shown in Scheme 8.

In principle, conjugated iminium ions should be more stable to hydrolysis than related nonconjugated iminium ions, certainly. Calculations indicate how much these equilibria are shifted to the right and permit their comparison.

We have included *N,N*-dimethylprolinamide in Scheme 8, as a model of Pro-containing peptides and of moderate-sized substituents that may help stabilize the charge of the CH=N⁺ moiety by interaction with the pyrrolidine substituent (the O atom of CONMe₂). With other models of similar features, such as *O*-methylprolinol (CH₂OMe as the substituent) and *O*-TBS-prolinol (CH₂OSi^tBuMe₂ as the substituent), the results were close to the case of *N,N*-dimethylprolinamide and are included in the Supporting Information.

The ΔE values under vacuum, shown in Scheme 8 for the addition reactions of cyanide ion to various eniminium ions arising from cinnamaldehyde and substituted pyrrolidines and imidazolidinones, are all negative and similar, between -7.7 and -8.9 kcal/mol. Thus, the steric effects—the size of the substituent at position 2 of the pyrrolidine ring—are not generally crucial for nonbranched conjugated aldehydes.

M06-2X/6-311+G(d,p)-based relative energies for representative exchanges of the MacMillan-1st generation catalyst)

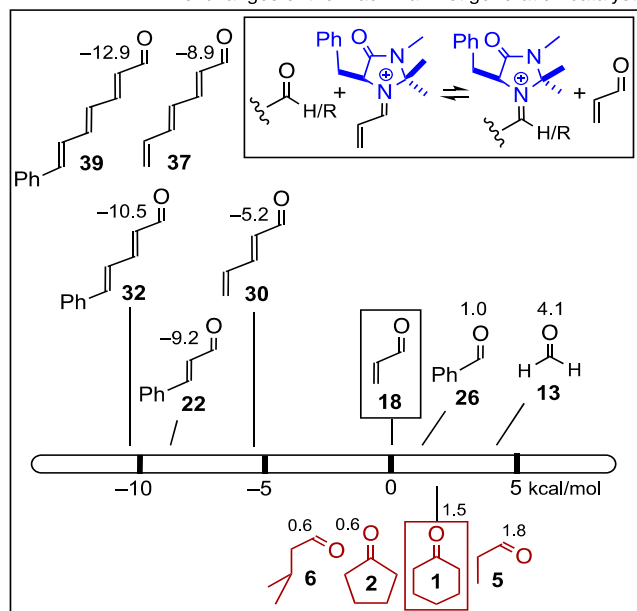

M06-2X/6-311+G(d,p)-based relative energies for representative exchanges of the MacMillan-2nd generation catalyst)

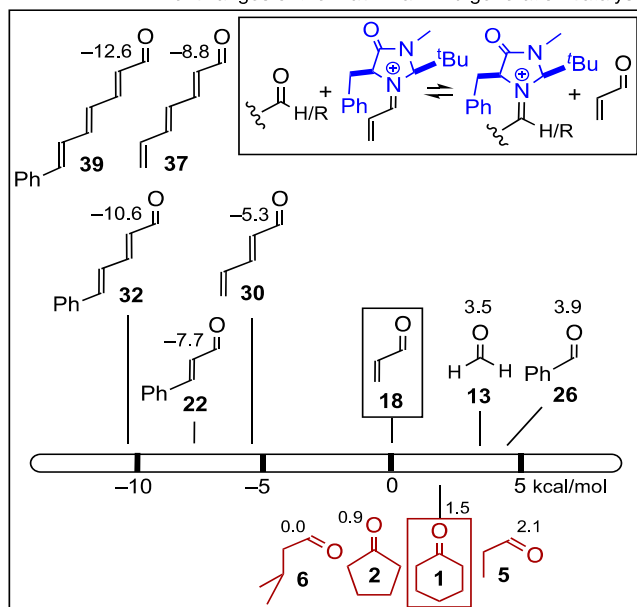

Figure 3. Relative energies in kcal/mol for the equilibria between carbonyl compounds and MacMillan-type iminium ions.

Obviously, the conjugated iminium ions are predicted to be intrinsically much more stable than the 3-cyanoiminium ions in relation to their enals and 3-cyanoaldehydes.

In very polar solvents, the equilibria shown in Scheme 8 appeared to be less exothermic, in accordance with the leveling effect evaluated in previous sections, but all of them are still shifted to the right. There are interesting differences, however. The predicted order, for the hydrolysis reaction, with the release of the catalyst and adduct PhCH(CN)CH₂CHO (22·HCN), when the species are “surrounded” by water, is



Scheme 7. Formation and Hydrolysis of Conjugated Iminium Salts Compared to Their Michael Adducts^a

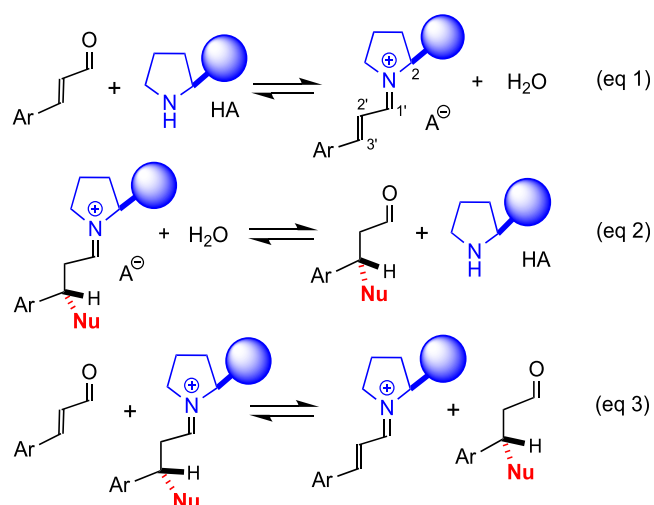

^aTransfer of substituted pyrrolidines between them (eq 3).

Calculations of the ΔG° values, for representative examples, are also included in Scheme 8. The results are parallel—the order is maintained—and often only 0.6–1.0 kcal/mol more negative than the ΔE values, as we observed in other cases discussed above and below. The differences between ΔE and ΔH° values were lower than or equal to 0.2 kcal/mol.

Thus, to our initial surprise, in very polar solvents (strictly, in those media where the ions are fully dissociated) the MacMillan catalysts are “the best”. The formation of their eniminium ions is not favored, as these catalysts are the less nucleophilic of the secondary amines studied here, and DFT calculations indicate that the corresponding eniminium ions are the less stable. However, what matters here is that the hydrolysis of the final iminium adducts (attack of water to the C=N⁺ carbon) is more favored. In principle, one may assume, bearing in mind that we are dealing with simple steps of “condensation” of secondary amines with unhindered carbonyl groups and the reverse reactions, the hydrolysis of iminium salts, that the respective energy barriers are usually low and that these steps are under thermodynamic control; the kinetic aspects of these exchanges and of the overall catalytic process under appropriate conditions^{14,15} are outside the scope of this work.

Nevertheless, many conjugate additions are not carried out in very polar solvents but in organic solvents of intermediate polarity or in mixtures of solvents. Therefore, we also considered the ion pairs, in CHCl₃. In these cases, the M06-2X method predicted higher compensation effects than in very polar solvents (which we attributed, after analyzing the final geometries, to favorable interaction of BF₄[−] with the PhCHCN moiety of the adducts). In Schemes 4 and 5, also the compensation effect due to the counterion turned out to be larger than that due to the polar solvents. What interested us more, anyway, was the relative order of the exchange energies. The most exergonic reactions, for example, are again those involving the McM1 and McM2 catalysts

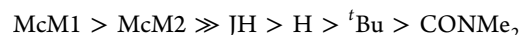

We also calculated some of these ion pairs in DMF and in water (see the Supporting Information). The outcome is

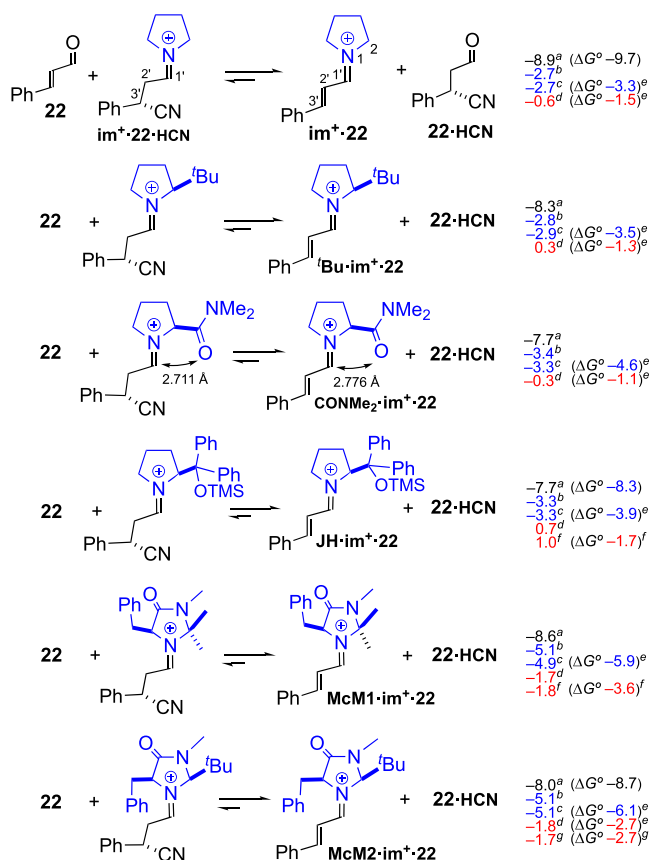
Scheme 8. Exchanges of Known Secondary Amines between 22 and Iminium Ions from Adducts^{a–g}

^a ΔE values in kcal/mol from M06-2X/6-311+G(d,p)//M06-2X/6-31G(d). ^b ΔE values in kcal/mol from M06-2X/6-311+G(d,p)-w-CPCM//M06-2X/6-31G(d). ^c ΔE values in kcal/mol from M06-2X/6-311+G(d,p)-w-CPCM. ^d ΔE values in kcal/mol for ion pairs (iminium tetrafluoroborates) and nonionic partners calculated at the M06-2X/6-311+G(d,p)-CHCl₃-CPCM level. ^eIn kcal/mol, from M06-2X/6-311+G(d,p)-optimized geometries in the different media (see Scheme S8, CPCM, Spartan'20). ^fIn kcal/mol, CPCM, Gaussian 16 (see Scheme S8). ^gIn kcal/mol, SMD, Gaussian 16 (see Scheme S8).

parallel to that in CHCl₃. This is again in accordance with the results shown in Schemes 4 and 5: if ion pairs are compared, the reaction medium is unimportant or is less important.

Thus, the imidazolidinones (MacMillan catalysts) here examined, once the nucleophilic addition has occurred, appear to have the highest propensity to be hydrolyzed. It can explain their success in Michael additions, in terms of turnover frequencies and/or reaction yields, even though their low nucleophilicity only suggested disadvantages regarding the formation of the initial iminium salts. It seems a paradox. Moreover, the higher electrophilicity of their iminium ions,¹⁵ which is reasonable due to the presence of EWGs in the nitrogenated ring, is also favorable.

With another C-nucleophile such as the nitromethane anion (⁻CH₂NO₂), our calculations also predict (Supporting Information) that the orders of the exchange energies are similar. Calculations of the ion pairs in CHCl₃, for the nitromethane addition, indicated that only exchange equilibria involving McM1 and McM2 are shifted to the right out of eight cases studied.

Application to Exchanges between New Simple Conjugated Iminium Ions and Their Michael Adducts.

Finally, to gain insight into a possible explanation of the differences between McM1/McM2 and pyrrolidine derivatives regarding the leveling effects caused by solvents and counterions, we have calculated exchange equilibria in which the PhCH₂ group on C5 or substituents on C2 and C5 were removed. The first results shown in Scheme 9, are almost identical to those shown in Scheme 8. Thus, the substituents are not important. The CONMe moiety of the MacMillan catalysts is key.

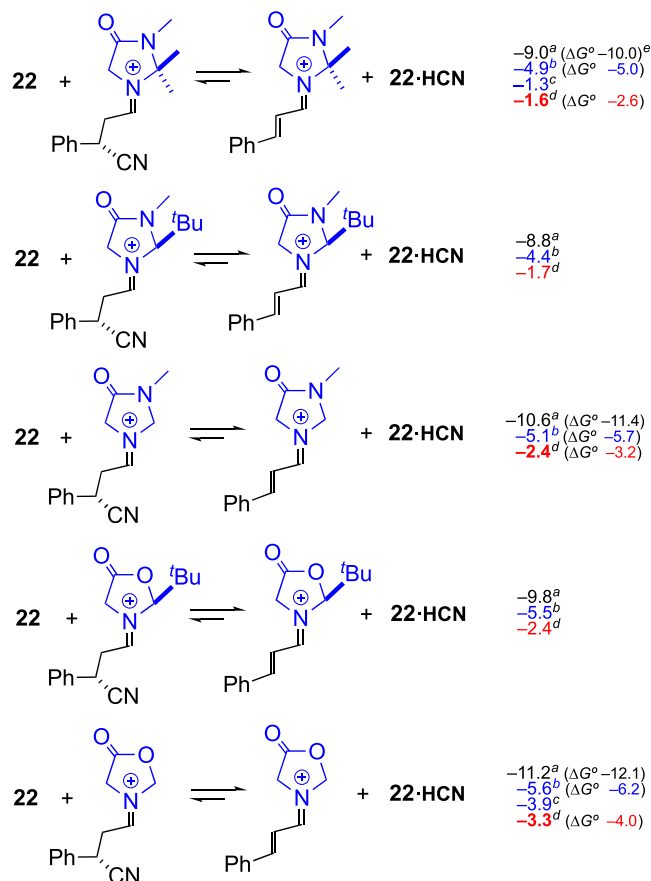
Scheme 9. Exchanges of Imidazolidinones and Oxazolidinones between 22 and Iminium Ions from Adducts^{a–e}

^a ΔE values in kcal/mol from M06-2X/6-311+G(d,p)//M06-2X/6-31G(d). ^b ΔE values in kcal/mol from M06-2X/6-311+G(d,p)-w-CPCM//M06-2X/6-31G(d). ^c ΔE values in kcal/mol for ion pairs (with BF₄⁻) and nonionic partners, optimized in water. ^d ΔE values in kcal/mol for ion pairs (with BF₄⁻) and nonionic partners, optimized in CHCl₃. ^eThe G° values were obtained from the corresponding M06-2X/6-311+G(d,p)-optimized geometries, with Spartan'20.

The last two examples in Scheme 9 (with COO groups in the ring, i.e., 1,3-oxazolidin-5-one derivatives) show exchange energies more favorable than the corresponding imidazolidinones. Other examples are included in the Supporting Information. In short, as it must be, EWGs in the ring relatively destabilize all of the aldiminium ions, nonconjugated and conjugated.

Meanwhile, polar solvents and BF₄⁻ reduce the energy differences between each pair of nonconjugated and

conjugated cations, but not proportionally: the leveling effects are different if the nitrogenated rings (the catalysts) contain EWGs. Even if the implicit solvent models gave approximate values (cf. [Computational Methods](#) section and the [Supporting Information](#) for comparisons), the relative order shown in [Schemes 8](#) and [9](#) is consistent. The calculated G values (see [Scheme S9](#) for details) are parallel to the ΔE values.

CONCLUSIONS

The formation and hydrolysis of series of azolidine-derived iminium ions have been compared and organized in scales, where the more conjugated or delocalized iminium ions are more stabilized. This is obvious, but the DFT calculations provide quantitative results that allow one to establish each scale in a reliable order. It is also well known that iminium ions are relatively more polar or polarized, and consequently more susceptible to resonance and inductive/field effects, than the corresponding carbonyl compounds. Polar media or the presence of a non-nucleophilic counterion (BF_4^-) give rise to expected leveling effects, which we have evaluated for the first time to the best of our knowledge, but the stability order is generally maintained. The same patterns have been observed with 2-CPh₂OTMS derivatives of pyrrolidine, as well as with derivatives of MacMillan imidazolidinones, for the enal/eniminium, dienal/dieniminium, and trienal/trieniminium pairs: with few exceptions, only the relative positions of ketones in the scales are significantly affected by the size of the substituents of the catalysts.

These scales of stability ([Figures 1–3](#)) may be useful for synthetic chemists dealing with aminocatalytic reactions, to compare reactions with different substrates as well as to gain insight into the results (when the steps under scrutiny are under thermodynamic control, which, in principle, is a general situation for the reactions of secondary amines with nonsterically hindered carbonyl compounds). These scales may also serve to foresee which iminium ions will be predominantly formed if the substrate contains two or more carbonyl groups, or if there are two or more aldehydes and ketones in a reaction flask. As observed by NMR, exchange equilibria are catalyzed by water.

Finally, as practical applications of the calculations on the relative stability of the iminium species, the connection with the completion of the amino-catalyzed addition of nucleophiles to conjugated enals was investigated. When α,β -unsaturated iminium ions are converted to saturated partners, these nonconjugated iminium ions are intrinsically more prone to hydrolysis, as qualitatively expected. In very polar solvents, all of the catalysts examined here should also give high conversions. However, not all of the azolidines are equal, as the leveling effects produced by polar solvents are not identical for each conjugated and nonconjugated pair: the iminium ions of the adducts from the MacMillan-2 and MacMillan-1 catalysts are predicted to show the highest propensity to be hydrolyzed. Furthermore, when ion pairs are considered, DFT calculations indicate that the exchange reactions are only significantly shifted to the right with McM2 and McM1. The presence of EWGs in the nitrogenated ring makes the corresponding iminium ions more prone to hydrolysis, as expected, but by means of the calculations, we have been able to numerically evaluate and explain the effect of various groups.

The corollary is that to design catalysts even better than those of MacMillan and co-workers, for obtaining high conversions in asymmetric Michael additions, less basic and/

or nucleophilic azolidines or piperidine derivatives should be investigated: even though the formation of their iminium salts may require looking for more appropriate acids and solvents, or even if these initial iminium salts are formed in very small amounts, the strong electrophilic character of these iminium ions and, as dealt with here, the favorable hydrolysis of the final iminium salts (those of the adducts) are more than compensatory.

All in all, we hope to have shown that the progress and completion of some aminocatalytic reactions may depend on and be predicted by the features of the intermediate iminium salts. We plan to gain insight into other reactions of iminium ions and to design catalysts that may compete with those examined here.

EXPERIMENTAL SECTION

Computational Methods. Most calculations were carried out with the Gaussian 16 package,¹⁶ many also with Spartan'18.2,¹⁷ and some with ORCA.¹⁸ The M06-2X/6-311+G(d,p) method⁷ was systematically used and all discussions are based on the results obtained with this method, which is often abbreviated as M06-2X throughout this work to save space in Figures and Schemes. For large molecules, with many conformational minima, we confirmed that there were no significant differences in the exchange energies (often ± 0.1 kcal/mol) between the M06-2X/6-311+G(d,p) and M06-2X/6-311+G(d,p)//M06-2X/6-31G(d) results so that we used this last approach for saving time; we have found few exceptions to this rule. Also, only the most stable “all-trans” species (double bonds of configuration *E* and *s-trans* conformations) of **18**, **22**, **30**, **32**, **37**, and **39**, as well as of the corresponding iminium ions, were systematically calculated.

Many preliminary results were obtained at the MP2/6-31G(d)//B3LYP/6-31G(d) level, which is the approach that afforded us¹⁹ the highest performance/cost ratio (once located all of the conformational minima—often a very high number—for each structure by B3LYP). Some of these results are included in the [Supporting Information](#); they are close to those obtained with M06-2X. In our hands, MP2 with large basis sets tends to overestimate the dispersion forces. Sometimes, to check the performance of MP2, the spin-component scaled MP2 (SCS-MP2)⁷ was applied.

The effect of very polar solvents (water, DMSO, DMF), and also sometimes of less polar solvents, was estimated by optimization of the equilibrium geometries and total energies with the implicit solvent methods²⁰ included in Spartan'18.2 and Gaussian 16, mainly with the conductor-like polarizable continuum model (CPCM) and with the SMD model (solvation model based on density), respectively.²⁰ Even though the total energy values were not identical (see the [Supporting Information](#) for several comparisons), the exchange energies were very close with the different approaches (± 1 kcal/mol, which is not relevant when a series of compounds were compared) and the relative order was maintained. This makes us believe that the relative reaction energies are reliable. The exchanges are also a confirmation of the reasonable effects of the substituents and solvents. When the effect of solvents was evaluated by single-point calculations rather than by optimization, it is indicated in figures and schemes; generally, the differences in the exchange energies were irrelevant (less than 0.1 kcal/mol).

When the calculations at the M06-2X level of the main conformers showed discrepancies or gave very close values for some of them, we carried out calculations with the CCSD(T)/6-311+G(d,p) method, with Gaussian 16, or obtained the free enthalpies (Gibbs free energies, G°) from the frequency calculations at the M06-2X/6-311+G(d,p) level, without using scaling factors or, when indicated, with reported scaling factors,¹⁰ to confirm whether the energy differences among the conformers were practically maintained or not. ΔG° values were also calculated for many exchange equilibria: G values with the CPCM method come from Spartan'20, unless otherwise indicated; those with the SMD method arise from Gaussian 16.

NMR Studies. Two representative exchange reactions were followed by ^1H NMR spectroscopy (400 MHz, CDCl_3), with the purpose of experimentally confirming the equilibrium position predicted by calculations; the spectra are reproduced in the Supporting Information. Samples of the two iminium salts involved in the first experiment were previously prepared in NMR tubes from pyrrolidinium tetrafluoroborate and commercially available cinnamaldehyde (**22**) and its 4-NMe₂ derivative (**44**), and used without isolation; the first cation (**im⁺·22**)^{9b} was reported as its chloride and both cations as perchlorates.^{9j} We also prepared **im⁺·22 TfO⁻**,^{9h} that is, the trifluoromethanesulfonate of **im⁺·22**, as a pure solid,^{9h} from **22**, trimethylsilylpyrrolidine, and trimethylsilyl triflate;⁹ after addition of **44** (up to 1.5 equiv), under strictly anhydrous conditions, no reaction occurred, but it sufficed to add to the NMR tube a drop of aqueous THF and shaking to observe the expected exchange (see the Supporting Information).

■ ASSOCIATED CONTENT

SI Supporting Information

The Supporting Information is available free of charge at <https://pubs.acs.org/doi/10.1021/acsomega.1c07020>.

Supporting data for selected figures and schemes of the main text; M06-2X equilibrium geometries; and NMR spectra (PDF)

■ AUTHOR INFORMATION

Corresponding Authors

Anna M. Costa – Organic Chemistry Section, Facultat de Química, Universitat de Barcelona, 08028 Barcelona, Catalonia, Spain; orcid.org/0000-0003-4345-4750; Email: amcosta@ub.edu

Jaume Vilarrasa – Organic Chemistry Section, Facultat de Química, Universitat de Barcelona, 08028 Barcelona, Catalonia, Spain; orcid.org/0000-0002-2522-8218; Email: jvilarrasa@ub.edu

Authors

Victor Cascales – Organic Chemistry Section, Facultat de Química, Universitat de Barcelona, 08028 Barcelona, Catalonia, Spain

Alejandro Castro-Alvarez – Organic Chemistry Section, Facultat de Química, Universitat de Barcelona, 08028 Barcelona, Catalonia, Spain; Present Address: Departamento de Ciencias Preclínicas, Facultad de Medicina, Universidad de La Frontera, 4810296 Temuco, Chile

Complete contact information is available at: <https://pubs.acs.org/10.1021/acsomega.1c07020>

Author Contributions

Gaussian'16 calculations were carried out by A.M.C. and A. C.-A., Spartan'18.2 and Spartan'20.0 by J.V., and ORCA by A.C.-A. Experimental work was performed by V.C. The manuscript was written by A.M.C. and J.V. All authors approved the final version of the manuscript.

Funding

Fundació Bosch Gimpera (UB) contract 310674.

Notes

The authors declare no competing financial interest.

■ ACKNOWLEDGMENTS

This study was started under the auspices of the CTQ2015-71506-R grant (Spanish Government + FEDER, Jan. 2016–Sept. 2019). Undergraduate students Alba Herrera (1st semester of 2019) and Maria Galofré (2nd semester of 2019) participated in preliminary calculations of some pyrrolidine and 2-*tert*-butylpyrrolidine derivatives, respectively. Expenses during 2020 and 2021 have been covered by the above-mentioned Fundació Bosch Gimpera contract.

■ REFERENCES

- (1) For some very recent reviews, see: (a) Han, B.; He, X.-H.; Liu, Y.-Q.; He, G.; Peng, C.; Li, J.-L. Asymmetric Organocatalysis: an Enabling Technology for Medicinal Chemistry. *Chem. Soc. Rev.* **2021**, *50*, 1522–1586. (b) Chevis, P. J.; Pyne, S. G. Synthesis of Enantioenriched α -Heteroatom Functionalized Aldehydes by Chiral Organocatalysis and Their Synthetic Applications. *Org. Chem. Front.* **2021**, *8*, 2287–2314. (c) Vachan, B. S.; Karuppusamy, M.; Vinoth, P.; Kumar, S. V.; Perumal, S.; Sridharan, V.; Menendez, J. C. Proline and its Derivatives as Organocatalysts for Multi-Component Reactions in Aqueous Media: Synergic Pathways to the Green Synthesis of Heterocycles. *Adv. Synth. Catal.* **2020**, *362*, 87–110. (d) Pawar, T. J.; Mitkari, S. B.; Peña-Cabrera, E.; Gómez, C. V.; Cruz, D. C. Polyenals and Polyenones in Aminocatalysis: A Decade Building Complex Frameworks from Simple Blocks. *Eur. J. Org. Chem.* **2020**, *2020*, 6044–6061. (e) Curti, C.; Battistini, L.; Sartori, A.; Zanardi, F. New Developments of the Principle of Vinylogy as Applied to π -Extended Enolate-Type Donor Systems. *Chem. Rev.* **2020**, *120*, 2448–2612. (f) Reyes-Rodríguez, G. J.; Rezayee, N. M.; Vidal-Albalat, A.; Jørgensen, K. A. Prevalence of Diarylprolinol Silyl Ethers as Catalysts in Total Synthesis and Patents. *Chem. Rev.* **2019**, *119*, 4221–4260. (g) Wang, L.; Liu, J. Recent Advances in Asymmetric Reactions Catalyzed by Proline and Its Derivatives. *Synthesis* **2016**, *49*, 960–972. (h) Heravi, M. M.; Zadsirjan, V.; Dehghani, M.; Hosseintash, N. Current Applications of Organocatalysts in Asymmetric Aldol Reactions: An Update. *Tetrahedron: Asymmetry* **2017**, *28*, 587–707. (i) Chauhan, P.; Mahajan, S.; Enders, D. Achieving Molecular Complexity via Stereoselective Multiple Domino Reactions Promoted by a Secondary Amine Organocatalyst. *Acc. Chem. Res.* **2017**, *50*, 2809–2821. (j) Reyes, E.; Uria, U.; Vicario, J. L.; Carrillo, L. Catalytic Enantioselective Michael Reaction. *Org. React.* **2016**, *90*, 1–898. (k) Lam, Y.-h.; Grayson, M. N.; Holland, M. C.; Simon, A.; Houk, K. N. Theory and Modeling of Asymmetric Catalytic Reactions. *Acc. Chem. Res.* **2016**, *49*, 750–762. (2) (a) Ahrendt, K. A.; Borths, C. J.; MacMillan, D. W. C. New Strategies for Organic Catalysis: The First Highly Enantioselective Organocatalytic Diels–Alder Reaction. *J. Am. Chem. Soc.* **2000**, *122*, 4243–4244. (b) Austin, J. F.; MacMillan, D. W. C. Enantioselective Organocatalytic Indole Alkylations. Design of a New and Highly Effective Chiral Amine for Iminium Catalysis. *J. Am. Chem. Soc.* **2002**, *124*, 1172–1173. (c) Lelais, G.; MacMillan, D. W. C. Modern Strategies in Organic Catalysis: The Advent and Development of Iminium Activation. *Aldrichimica Acta* **2006**, *39*, 79–87. (3) (a) Marigo, M.; Wabnitz, T. C.; Fielenbach, D.; Jørgensen, K. A. Enantioselective Organocatalyzed α -Sulfonylation of Aldehydes.

- Angew. Chem., Int. Ed.* **2005**, *44*, 794–797. (b) Hayashi, Y.; Gotoh, H.; Hayashi, T.; Shoji, M. Diphenylprolinol Silyl Ethers as Efficient Organocatalysts for the Asymmetric Michael Reaction of Aldehydes and Nitroalkenes. *Angew. Chem., Int. Ed.* **2005**, *44*, 4212–4215.
- (4) (a) Seebach, D.; Grošelj, U.; Badine, D. M.; Schweizer, W. B.; Beck, A. K. Isolation and X-Ray Structures of Reactive Intermediates of Organocatalysis with Diphenylprolinol Ethers and with Imidazolidinones. A Survey and Comparison with Computed Structures and with 1-Acyl-imidazolidinones: The 1,5-Repulsion and the Geminal-Diaryl Effect at Work. *Helv. Chim. Acta* **2008**, *91*, 1999–2034. (b) Hayashi, Y.; Okamura, D.; Yamazaki, T.; Ameda, Y.; Gotoh, H.; Tsuzuki, S.; Uchimaru, T.; Seebach, D. A Theoretical and Experimental Study of the Effects of Silyl Substituents in Enantioselective Reactions Catalyzed by Diphenylprolinol Silyl Ether. *Chem. - Eur. J.* **2014**, *20*, 17077–17088. (c) Halskov, K. S.; Donslund, B. S.; Paz, B. M.; Jørgensen, K. A. Computational Approach to Diarylprolinol-Silyl Ethers in Aminocatalysis. *Acc. Chem. Res.* **2016**, *49*, 974–986. (d) Seebach, D.; Grošelj, U.; Schweizer, W. B.; Grimme, S.; Muck-Lichtenfeld, C. Experimental and Theoretical Conformational Analysis of 5-Benzylimidazolidin-4-one Derivatives – a “Playground” for Studying Dispersion Interactions and a “Windshield Wiper” Effect in Organocatalysis. *Helv. Chim. Acta* **2010**, *93*, 1–16. (e) Krenske, E. H.; Houk, K. N.; Harmata, M. Computational Analysis of the Stereochemical Outcome in the Imidazolidinone-Catalyzed Enantioselective (4 + 3)-Cycloaddition Reaction. *J. Org. Chem.* **2015**, *80*, 744–750. (f) Nielsen, M.; Worgull, D.; Zweifel, T.; Gschwend, B.; Bertelsen, S.; Jørgensen, K. A. Mechanisms in Aminocatalysis. *Chem. Commun.* **2011**, *47*, 632–649. (g) Cheong, P. H.-Y.; Legault, C. Y.; Um, J. M.; Çelebi-Ölçüm, N.; Houk, K. N. Quantum Mechanical Investigations of Organocatalysis: Mechanisms, Reactivities, and Selectivities. *Chem. Rev.* **2011**, *111*, 5042–5137. (h) Yang, H.; Wong, M. W. (S)-Proline-Catalyzed Nitro-Michael Reactions: Towards a Better Understanding of the Catalytic Mechanism and Enantioselectivity. *Org. Biomol. Chem.* **2012**, *10*, 3229–3235. (i) Ribas-Ariño, J.; Carvajal, M. A.; Chaumont, A.; Masia, M. Unraveling the Role of Water in the Stereoselective Step of Aqueous Proline-Catalyzed Aldol Reactions. *Chem. - Eur. J.* **2012**, *18*, 15868–15874. (j) Walden, D. M.; Ogbay, O. M.; Johnston, R. C.; Cheong, P. H. Computational Insights into the Central Role of Nonbonding Interactions in Modern Covalent Organocatalysis. *Acc. Chem. Res.* **2016**, *49*, 1279–1291. (k) Hooper, J. F.; James, N. C.; Bozkurt, E.; Aviyente, V.; White, J. M.; Holland, M. C.; Gilmour, R.; Holmes, A. B.; Houk, K. N. Medium-Ring Effects on the Endo/Exo Selectivity of the Organocatalytic Intramolecular Diels–Alder Reaction. *J. Org. Chem.* **2015**, *80*, 12058–12075. (l) Świderek, K.; Nödling, A. R.; Tsai, Y.-H.; Luk, L. Y. P.; Moliner, V. Reaction Mechanism of Organocatalytic Michael Addition of Nitromethane to Cinnamaldehyde: A Case Study on Catalyst Regeneration and Solvent Effects. *J. Phys. Chem. A* **2018**, *122*, 451–459. (m) Zhang, J.; Chen, Q.; Mayer, R. J.; Yang, J.-D.; Ofial, A. R.; Cheng, J.-P.; Mayr, H. Predicting Absolute Rate Constants for Huisgen Reactions of Unsaturated Iminium Ions with Diazoalkanes. *Angew. Chem., Int. Ed.* **2020**, *59*, 12527–12533.
- (5) (a) Maas, W.; Janssen, M. J.; Stamhuis, E. J.; Wynberg, H. Mechanism of Enamine Reactions. IV. The Hydrolysis of Tertiary Enamines in Acidic Medium. *J. Org. Chem.* **1967**, *32*, 1111–1115. (b) Sollenberger, P. Y.; Martin, R. B. Mechanism of Enamine Hydrolysis. *J. Am. Chem. Soc.* **1970**, *92*, 4261–4270.
- (6) For examples of very recent reviews, see: (a) Rey, Y. P.; Hepburn, H. B.; Melchiorre, P. Organocatalysis with Amines in Photocatalysis. In *Science of Synthesis: Photocatalysis in Organic Synthesis*, König, B., Ed.; Thieme: Stuttgart, 2019; Vol. 1, pp 243–270. (b) Liu, Y.-Y.; Liu, J.; Lu, L.-Q.; Xiao, W.-J. Organocatalysis Combined with Photocatalysis. *Top. Curr. Chem.* **2019**, *377*, No. 37. (c) Zou, Y.-Q.; Hoermann, F. M.; Bach, T. Iminium and Enamine Catalysis in Enantioselective Photochemical Reactions. *Chem. Soc. Rev.* **2018**, *47*, 278–290. (d) Zhu, L.; Wang, D.; Jia, Z.; Lin, Q.; Huang, M.; Luo, S. Catalytic Asymmetric Oxidative Enamine Transformations. *ACS Catal.* **2018**, *8*, 5466–5484.
- (7) (a) Zhao, Y.; Truhlar, D. G. The M06 Suite of Density Functionals for Main Group Thermochemistry, Thermochemical Kinetics, Noncovalent Interactions, Excited States, and Transition Elements: Two New Functionals and Systematic Testing of Four M06-Class Functionals and 12 Other Functions. *Theor. Chem. Acc.* **2008**, *120*, 215–241. (b) Zhao, Y.; Truhlar, D. G. Density Functionals with Broad Applicability in Chemistry. *Acc. Chem. Res.* **2008**, *41*, 157–167.
- (8) (a) Grimme, S. Improved Second-Order Møller–Plesset Perturbation Theory by Separate Scaling of Parallel- and Antiparallel-Spin Pair Correlation Energies. *J. Chem. Phys.* **2003**, *118*, 9095–9102. (b) Fink, R. F. Spin-Component-Scaled Møller–Plesset (SCS-MP) Perturbation Theory: A Generalization of the MP Approach with Improved Properties. *J. Chem. Phys.* **2010**, *133*, No. 174113. (c) Grimme, S.; Goerigk, L.; Fink, R. F. Spin Component Scaled Electron Correlation Methods. *Wiley Interdiscip. Rev.: Comput. Mol. Sci.* **2012**, *2*, 886–906.
- (9) For reported iminium salts of pyrrolidine derivatives, see: (a) Evans, G. J. S.; White, K.; Platts, J. A.; Tomkinson, N. C. O. Computational Study of Iminium Ion Formation: Effects of Amine Structure. *Org. Biomol. Chem.* **2006**, *4*, 2616–2627. (b) Leonard, N. J.; Jann, K. Small Charged Rings. II. The Synthesis of Aziridinium Salts. *J. Am. Chem. Soc.* **1962**, *84*, 4806–4813. (c) Leonard, N. J.; Paukstelis, J. V. Direct Synthesis of Ternary Iminium Salts by Combination of Aldehydes or Ketones with Secondary Amine Salts. *J. Org. Chem.* **1963**, *28*, 3021–3024. (d) de Nie-Sarink, M. J.; Pandit, U. K. NADH models. Part XII. Chemoselectivity of the Reduction of Phenyl-Substituted α,β -Unsaturated Iminium Salts by an NADH Model. *Tetrahedron Lett.* **1979**, *26*, 2449–2452. (e) Ahlbrecht, H.; Schmitt, C. Lithium *N*-Lithiomethylthiocarbamates: New *N*-Alkylaminomethyl Anion Equivalents; III. 2-Imidazolidinethiones and 1,2-Diamines via Electrophilic Aminoalkylation with Imines and Iminium Salts. *Synthesis* **1994**, 719–722. (f) Schroth, W.; Jahn, U.; Stroehl, D. New Syntheses of Methyleniminium Salts from Carbonyl Compounds and from α -Chloro Ethers; an Access to Vinylogous Viehe Salts. *Chem. Ber.* **1994**, *127*, 2013–2022. (g) Saba, S.; Vrkić, D.; Cascella, C.; DaSilva, I.; Carta, K.; Kojtari, A. One-Pot Preparation of Ternary and Quaternary Iminium Salts from Aldehydes and Ketones. *J. Chem. Res.* **2008**, 301–304. (h) Lakhdar, S.; Tokuyasu, T.; Mayr, H. Electrophilic Reactivities of α,β -Unsaturated Iminium Ions. *Angew. Chem., Int. Ed.* **2008**, *47*, 8723–8726. (i) Fleischer, I.; Pfaltz, A. Enantioselective Michael Addition to α,β -Unsaturated Aldehydes: Combinatorial Catalyst Preparation and Screening, Reaction Optimization, and Mechanistic Studies. *Chem. - Eur. J.* **2010**, *16*, 95–99. (j) Lasogga, L.; Rettig, W.; Otto, H.; Wallat, I.; Bricks, J. Model System for the Investigation of the Opsin Shift in Bacteriorhodopsin. *J. Phys. Chem. A* **2010**, *114*, 2179–2188. (k) Tanzer, E.-M.; Zimmer, L. E.; Schweizer, W. B.; Gilmour, R. Fluorinated Organocatalysts for the Enantioselective Epoxidation of Enals: Molecular Preorganization by the Fluorine-Iminium Ion Gauche Effect. *Chem. - Eur. J.* **2012**, *18*, 11334–11342. (l) Georgieva, M. K.; Duarte, F. J. S.; Santos, A. G. Directed Electrostatic Activation in Enantioselective Organocatalytic Cyclopropanation Reactions: A Computational Study. *Org. Biomol. Chem.* **2016**, *14*, 5965–5982. (m) Spitz, C.; Giuglio-Tonolo, A. G.; Terme, T.; Vanelle, P. Metal-Free Regiodivergent Addition of Carbon Nucleophiles to α,β -Unsaturated Electrophiles. *Molecules* **2017**, *22*, No. 1178. (n) Ghosh, A.; Biju, A. T. Revealing the Similarities of α,β -Unsaturated Iminiums and Acylazoliums in Organocatalysis. *Angew. Chem., Int. Ed.* **2021**, *60*, 13712–13724. For entries to DFT calculations of imidazolium tetrafluoroborates (ionic liquids), see: (o) Thomas, E.; Vijayalakshmi, K. P.; George, B. K. Imidazolium Based Energetic Ionic Liquids for Monopropellant Applications: A Theoretical Study. *RSC Adv.* **2015**, *5*, 71896–71902. (p) López-López, J. A.; Ayala, R. Assessment of the Performance of Commonly Used DFT Functionals vs. MP2 in the Study of IL-Water, IL-Ethanol and IL-(H₂O)₃ Clusters. *J. Mol. Liq.* **2016**, *220*, 970–982.
- (10) (a) Kanchanakungwankul, S.; Bao, J. L.; Zheng, J.; Alecu, I. M.; Linch, B. J.; Zhao, Y.; Truhlar, D. G. *Database of Frequency Scale Factors for Electronic Model Chemistries*, Version 5, 2021. (b) Únal, Y.;

Nassif, W.; Özyaydin, B. C.; Sayin, K. Scale Factor Database for the Vibration Frequencies Calculated in M06-2X, One of the DFT Methods. *Vib. Spectrosc.* **2021**, *112*, No. 103189, For correcting vibrational frequencies, a factor of 0.9569 has been determined.

(11) (a) Poe, S. L.; Bogdan, A. R.; Mason, B. P.; Steinbacher, J. L.; Opalka, S. M.; McQuade, D. T. Use of Bifunctional Ureas to Increase the Rate of Proline-Catalyzed α -Aminoxylations. *J. Org. Chem.* **2009**, *74*, 1574–1580. (b) Seebach, D.; Yoshinari, T.; Beck, A. K.; Ebert, M.-O.; Castro-Alvarez, A.; Vilarrasa, J.; Reiher, M. How Small Amounts of Impurities Are Sufficient to Catalyze the Interconversion of Carbonyl Compounds and Iminium Ions, or Is There a Metathesis through 1,3-Oxazetidinium Ions? Experiments, Speculations, and Calculations. *Helv. Chim. Acta* **2014**, *97*, 1177–1203. (c) The 1,3-oxazetidinium intermediate from pyrrolidine and two molecules of ethanal is predicted to be 1.0 and 16.0 kcal/mol [ΔH° and ΔG° , respectively, at the M06-2X/6-311+G(d,p) level] and 5.7 and 20.6 kcal/mol (idem, in water as the implicit solvent) above the initial iminium ion. The issue is that the energy barrier was calculated to be very high. This has now been corroborated, since for the corresponding reaction of *N*-ethylidenepyrrolidinium ion with ethanal at the M06-2X/6-311+G(d,p) level, the barrier appears to be 24 kcal/mol ($\Delta G^\ddagger \approx 40$ kcal/mol). Other reaction mechanisms, such as the exchange of pyrrolidine via partial hydrolysis, are more probable. (d) Exchange of pyrrolidine between two carbonyl compounds according to the chemical equations shown in the main text, catalyzed by a trace amount of water, seems more likely.

(12) For other studies including DFT calculations, see: (a) Grošelj, U.; Seebach, D.; Badine, D. M.; Schweizer, W. B.; Beck, A. K.; Krossing, I.; Klose, P.; Hayashi, Y.; Uchamaru, T. Structures of the Reactive Intermediates in Organocatalysis with Diarylprolinol Ethers. *Helv. Chim. Acta* **2009**, *92*, 1225–1259. (b) Gotoh, H.; Uchamaru, T.; Hayashi, Y. Two Reaction Mechanisms via Iminium Ion Intermediates: The Different Reactivities of Diphenylprolinol Silyl Ether and Trifluoromethyl-Substituted Diarylprolinol Silyl Ether. *Chem. - Eur. J.* **2015**, *21*, 12337–12346.

(13) For other DFT calculations of iminium salts from the MacMillan catalysts, see: (a) Brazier, J. B.; Evans, G.; Gibbs, T. J. K.; Coles, S. J.; Hursthouse, M. B.; Platts, J. A.; Tomkinson, N. C. O. Solution Phase, Solid State, and Theoretical Investigations on the MacMillan Imidazolidinone. *Org. Lett.* **2009**, *11*, 133–136. (b) Holland, M. C.; Paul, S.; Schweizer, W. B.; Bergander, K.; Mueck-Lichtenfeld, C.; Lakhdar, S.; Mayr, H.; Gilmour, R. Noncovalent Interactions in Organocatalysis: Modulating Conformational Diversity and Reactivity in the MacMillan Catalyst. *Angew. Chem., Int. Ed.* **2013**, *52*, 7967–7971. (c) Holland, M. C.; Metternich, J. B.; Mück-Lichtenfeld, C.; Gilmour, R. Cation- π Interactions in Iminium Ion Activation: Correlating Quadrupole Moment and Enantioselectivity. *Chem. Commun.* **2015**, *51*, 5322–5325.

(14) For examples of aminocatalyzed additions of nucleophiles to cinnamaldehyde, see: (a) Zu, L.; Xie, H.; Li, H.; Wang, J.; Wang, W. Highly Enantioselective Organocatalytic Conjugate Addition of Nitromethane to α,β -Unsaturated Aldehydes: Three-Step Synthesis of Optically Active Baclofen. *Adv. Synth. Catal.* **2007**, *349*, 2660–2664. (b) Cid, M. B.; Duce, S.; Morales, S.; Rodrigo, E.; García-Ruano, J. L. Nitrophenylacetone nitriles as Versatile Nucleophiles in Enantioselective Organocatalytic Conjugate Additions. *Org. Lett.* **2010**, *12*, 3586–3589. (c) Świderek, K.; Nödling, A. R.; Tsai, Y.-H.; Luk, L. Y. P.; Moliner, V. Reaction Mechanism of Organocatalytic Michael Addition of Nitromethane to Cinnamaldehyde: A Case Study on Catalyst Regeneration and Solvent Effects. *J. Phys. Chem. A* **2018**, *122*, 451–459. For related additions: (d) Oliva, C. G.; Silva, A. M. S.; Resende, D. I. S. P.; Paz, F. A. A.; Cavaleiro, J. A. S. Highly Enantioselective 1,4-Michael Additions of Nucleophiles to Unsaturated Aryl Ketones with Organocatalysis by Bifunctional Cinchona Alkaloids. *Eur. J. Org. Chem.* **2010**, *2010*, 3449–3458. (e) Hayashi, Y.; Okamura, D.; Umemiya, S.; Uchamaru, T. Organocatalytic 1,4-Addition Reaction of $\alpha,\beta,\gamma,\delta$ -Diunsaturated Aldehydes versus 1,6-Addition Reaction. *ChemCatChem* **2012**, *4*, 959–962.

(15) For kinetic studies of the electrophilicity of iminium ions ($\text{McM2}\cdot\text{im}^+\cdot\text{22} > \text{McM1}\cdot\text{im}^+\cdot\text{22} > \text{JH}\cdot\text{im}^+\cdot\text{22} > \text{im}^+\cdot\text{22}$), see: (a) Ref 9h. (b) Lakhdar, S.; Ofial, A. R.; Mayr, H. Reactivity Parameters for Rationalizing Iminium-Catalyzed Reactions. *J. Phys. Org. Chem.* **2010**, *23*, 886–892. (c) Lakhdar, S.; Ammer, J.; Mayr, H. Generation of α,β -Unsaturated Iminium Ions by Laser Flash Photolysis. *Angew. Chem., Int. Ed.* **2011**, *50*, 9953–9956. (d) The reaction rates of $\text{McM2}\cdot\text{im}^+\cdot\text{22 PF}_6^-$ with several nucleophiles in CH_3CN are higher than those of $\text{McM1}\cdot\text{im}^+\cdot\text{22 PF}_6^-$, which is explained by the lower steric hindrance around the C_β Si face of the first cation.

(16) Frisch, M. J.; Trucks, G. W.; Schlegel, H. B.; Scuseria, G. E.; Robb, M. A.; Cheeseman, J. R.; Scalmani, G.; Barone, V.; Petersson, G. A.; Nakatsuji, H.; Li, X.; Caricato, M.; Marenich, A. V.; Bloino, J.; Janesko, B. G.; Gomperts, R.; Mennucci, B.; Hratchian, H. P.; Ortiz, J. V.; Izmaylov, A. F.; Sonnenberg, J. L.; Williams-Young, D.; Ding, F.; Lipparini, F.; Egidi, F.; Goings, J.; Peng, B.; Petrone, A.; Henderson, T.; Ranasinghe, D.; Zakrzewski, V. G.; Gao, J.; Rega, N.; Zheng, G.; Liang, W.; Hada, M.; Ehara, M.; Toyota, K.; Fukuda, R.; Hasegawa, J.; Ishida, M.; Nakajima, T.; Honda, Y.; Kitao, O.; Nakai, H.; Vreven, T.; Throssell, K.; Montgomery, J. A., Jr.; Peralta, J. E.; Ogliaro, F.; Bearpark, M. J.; Heyd, J. J.; Brothers, E. N.; Kudin, K. N.; Staroverov, V. N.; Keith, T. A.; Kobayashi, R.; Normand, J.; Raghavachari, K.; Rendell, A. P.; Burant, J. C.; Iyengar, S. S.; Tomasi, J.; Cossi, M.; Millam, J. M.; Klene, M.; Adamo, C.; Cammi, R.; Ochterski, J. W.; Martin, R. L.; Morokuma, K.; Farkas, O.; Foresman, J. B.; Fox, D. J. *Gaussian 16*, Revision C.01; Gaussian, Inc.: Wallingford, CT, 2016.

(17) Deppmeier, B.; Driessen, A.; Hehre, T.; Hehre, W.; Klunzinger, P.; Ohlinger, S.; Schnitker, J. *Spartan'18*, (18 2, v 1.4.6); Wavefunction, Inc.: Irvine, CA, 2019.

(18) Neese, F.; Wennmohs, F.; Becker, U.; Riplinger, C. The ORCA Quantum Chemistry Program Package. *J. Chem. Phys.* **2020**, *152*, No. 224108.

(19) (a) Castro-Alvarez, A.; Carneros, H.; Sánchez, D.; Vilarrasa, J. Importance of the Electron Correlation and Dispersion Corrections in Calculations Involving Enamines, Hemiaminals, and Aminals. Comparison of B3LYP, M06-2X, MP2, and CCSD Results with Experimental Data. *J. Org. Chem.* **2015**, *80*, 11977–11985. (b) Castro-Alvarez, A.; Carneros, H.; Costa, A. M.; Vilarrasa, J. Computer-Aided Insight into the Relative Stability of Enamines. *Synthesis* **2017**, *49*, 5285–5306. (a review requested by the Editor) (c) Castro-Alvarez, A.; Carneros, H.; Calafat, J.; Costa, A. M.; Marco, C.; Vilarrasa, J. NMR and Computational Studies on the Reactions of Enamines with Nitroalkenes that May Pass through Cyclobutanes. *ACS Omega* **2019**, *4*, 18167–18194.

(20) The performance of the implicit solvent models is a hot topic, with criticisms often addressed to the SMD and related methods in special cases such as those that follow: (a) Lian, P.; Johnston, R. C.; Parks, J. M.; Smith, J. C. Quantum Chemical Calculation of pK_a s of Environmentally Relevant Functional Groups: Carboxylic Acids, Amines and Thiols in Aqueous Solution. *J. Phys. Chem. A* **2018**, *122*, 4366–4374. (b) Chen, J.; Shao, Y.; Ho, J. Are Explicit Solvent Models More Accurate than Implicit Solvent Models? A Case Study on the Menschutkin Reaction. *J. Phys. Chem. A* **2019**, *123*, 5580–5589. (c) Xu, L.; Coote, M. L. Methods to Improve the Calculations of Solvation Model Density Solvation Free Energies and Associated Aqueous pK_a Values: Comparison between Choosing an Optimal Theoretical Level, Solute Cavity Scaling, and Using Explicit Solvent Molecules. *J. Phys. Chem. A* **2019**, *123*, 7430–7438.