

***GÈNESI I EVOLUCIÓ DE L'ESTRUCTURA  
DEL POBLAMENT IBÈRIC EN EL CURS  
INFERIOR DEL RIU EBRE:  
LA ILERCAVÒNIA SEPTENTRIONAL***

***VOLUM II***

***JAUME NOGUERA GUILLÉN***

**LÀMINES:**

**LÀM. 1-84. MATERIALS MOBLES**

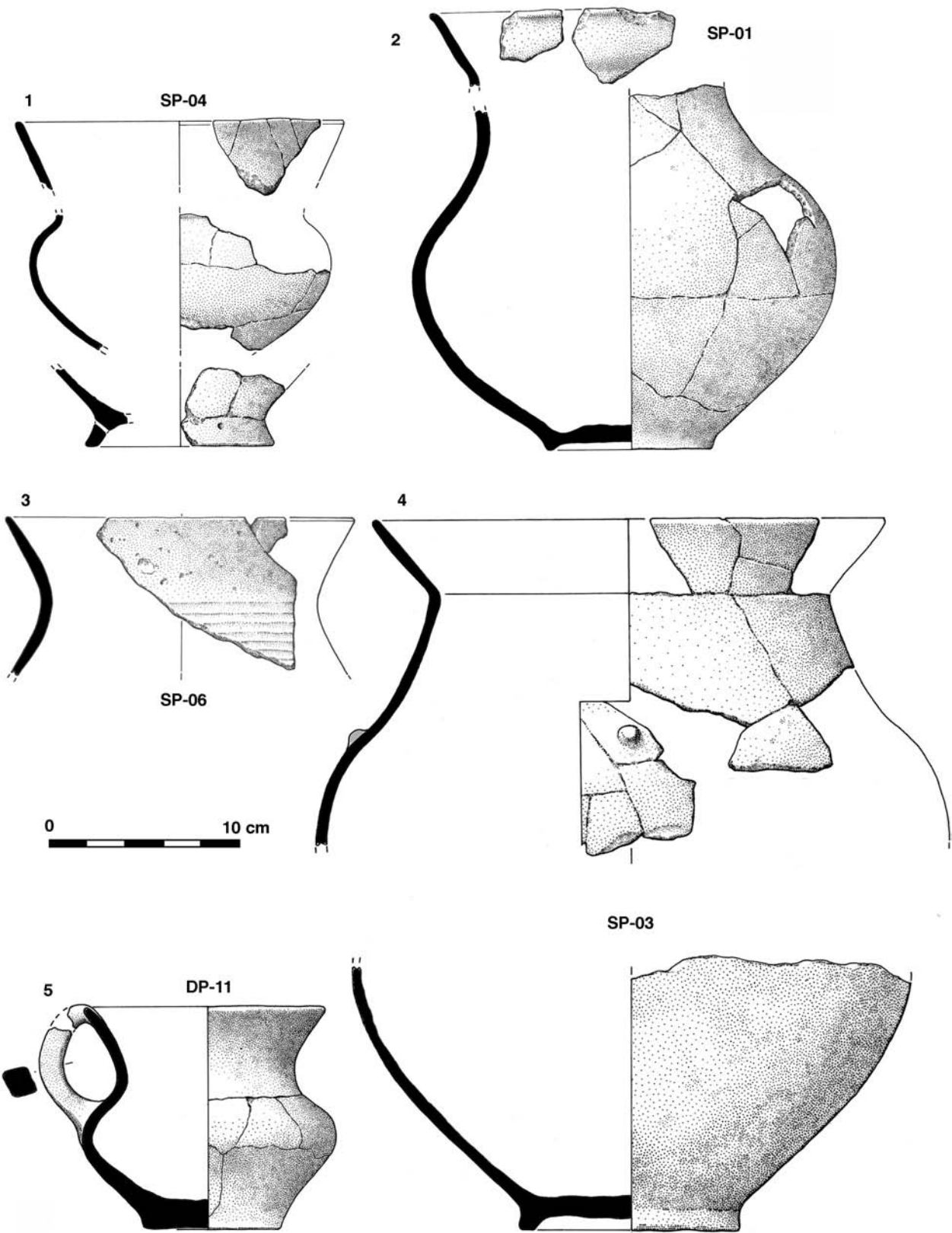

Làm. 1: Material ceràmic a mà de la necròpolis de Santa Madrona [5]. Riba-roja. (dibuixos R. Alvarez).



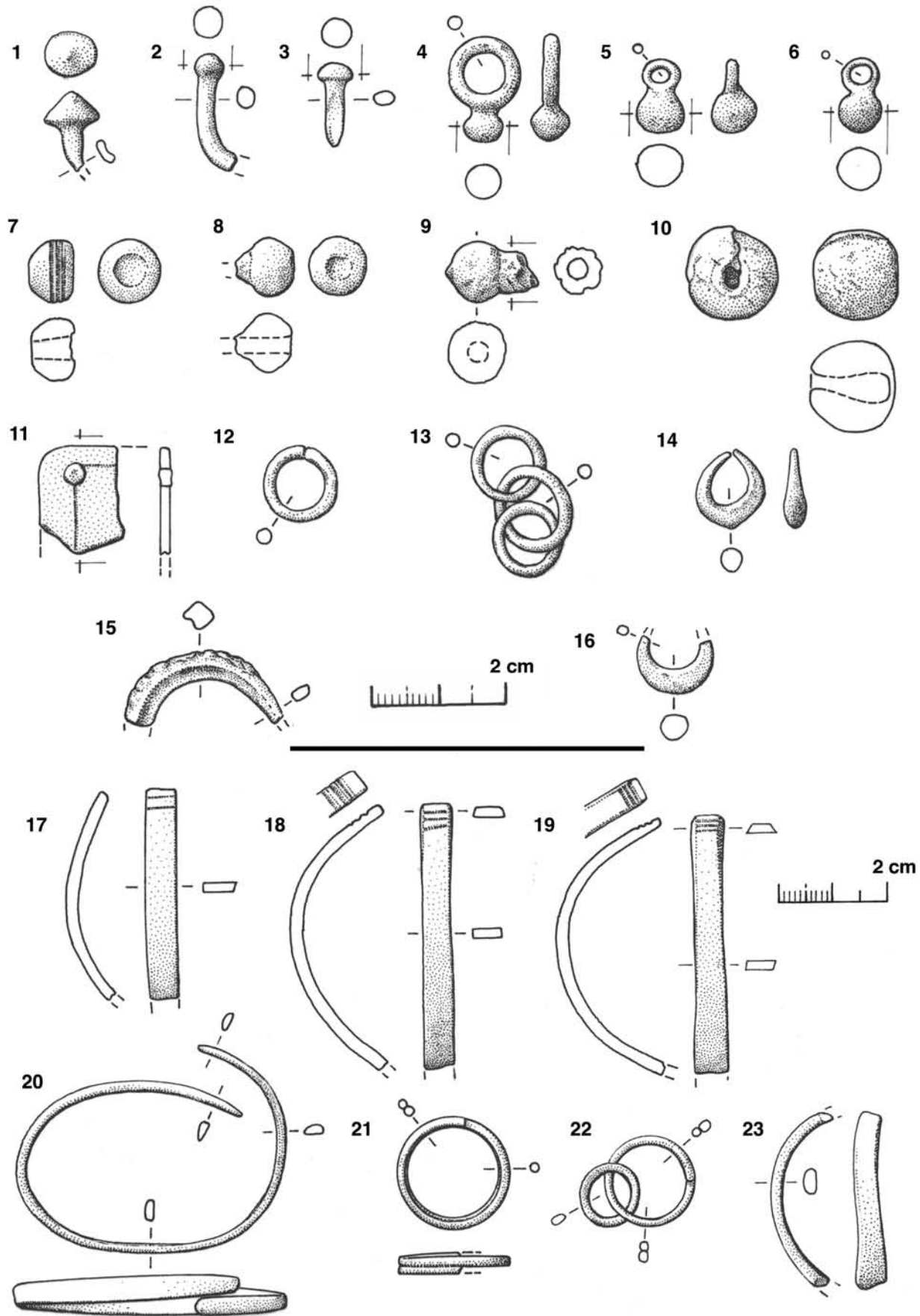

Làm. 2 : Material metàl·lic de la necròpolis de Santa Madrona [5]. Riba-roja.

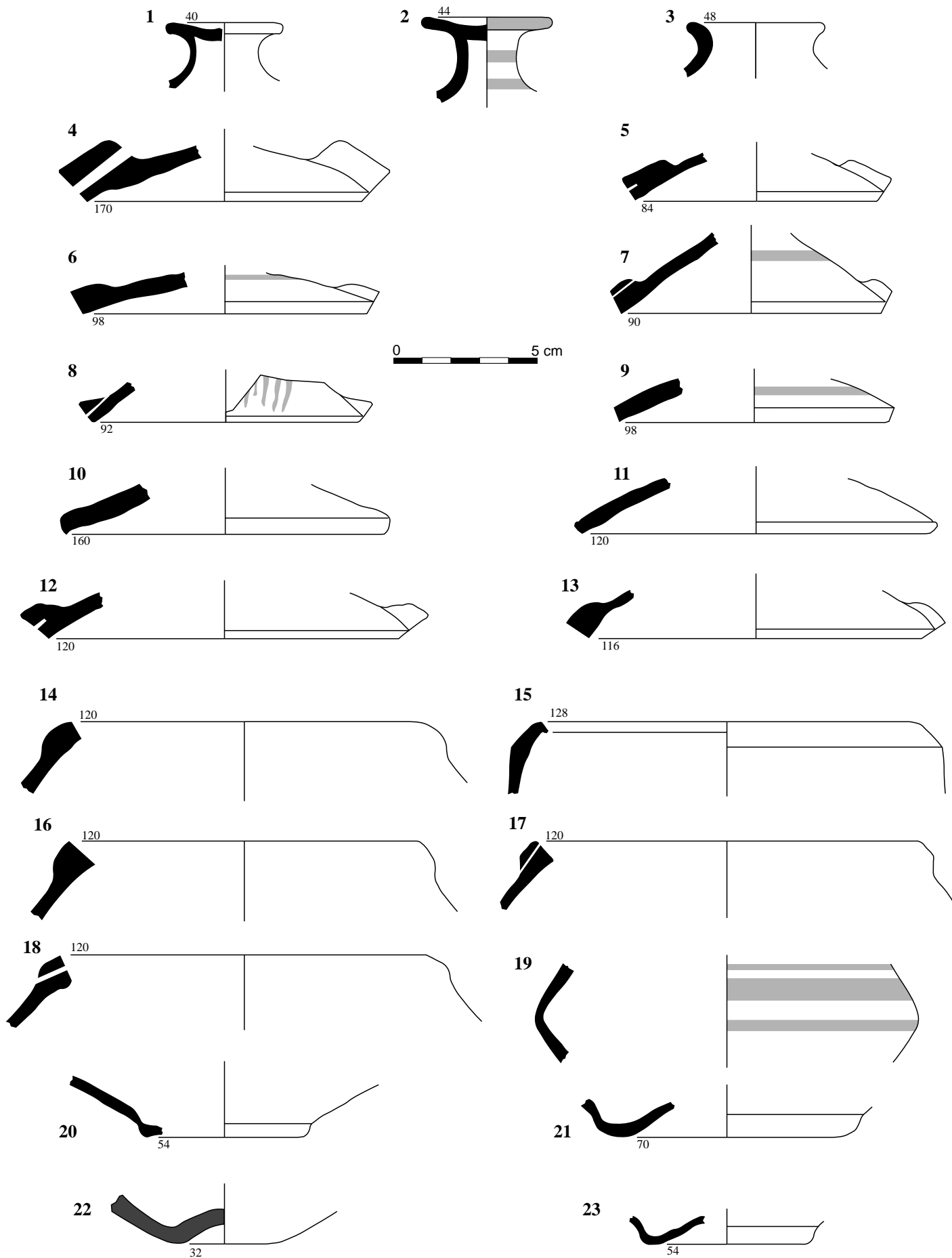

Làm. 3: Fragments de tapadores, vores i bases d'urnes de tancament hermètic de la necròpolis ibèrica de Santa Madrona [5] (Riba-roja). Material superficial.

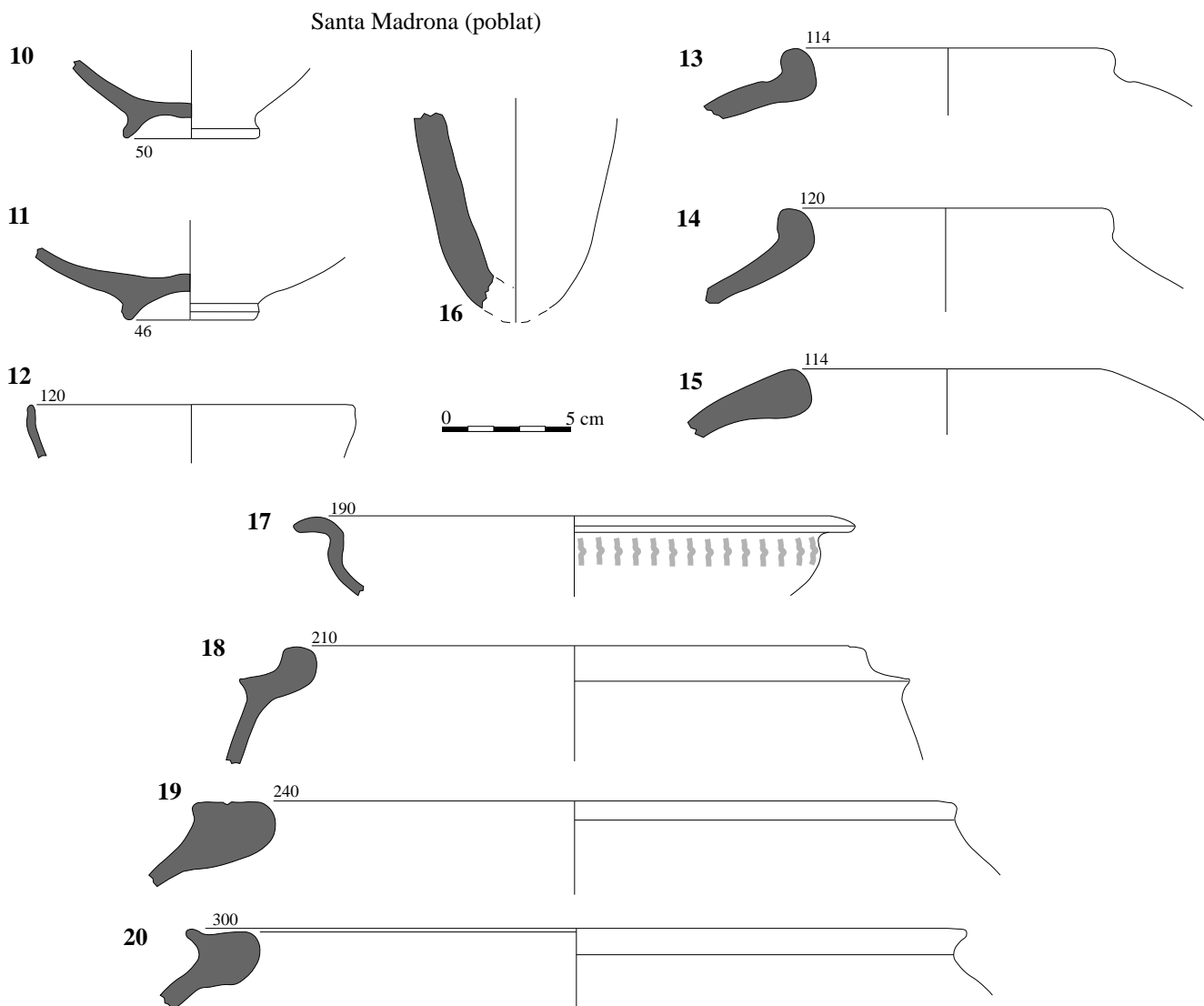
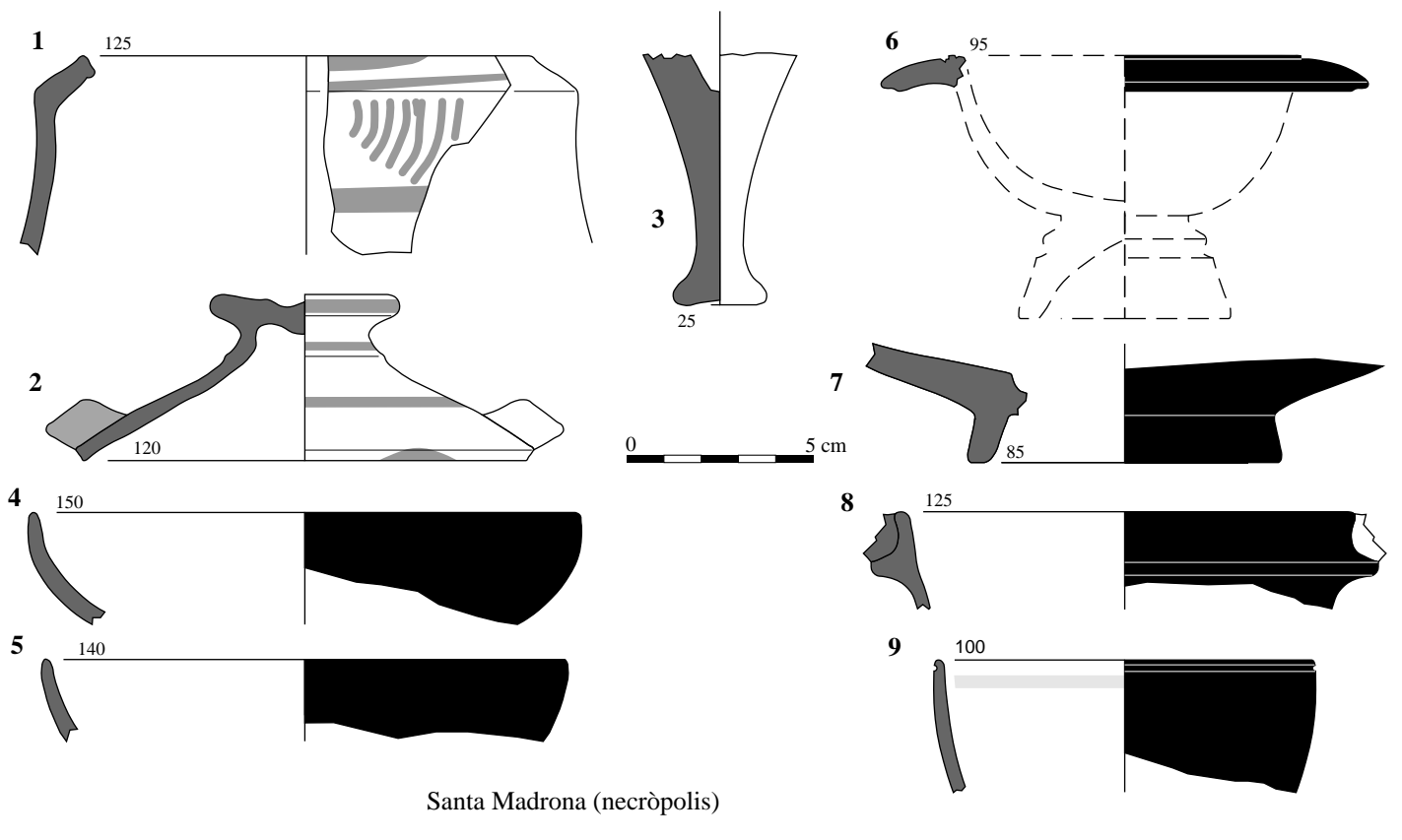

Làm. 4: Material ceràmic a torn de Santa Madrona. 1-9: Material superficial de la necròpolis [5]. 10-20: Material superficial del poblat [4]. (Riba-roja).

Vall de Porcs

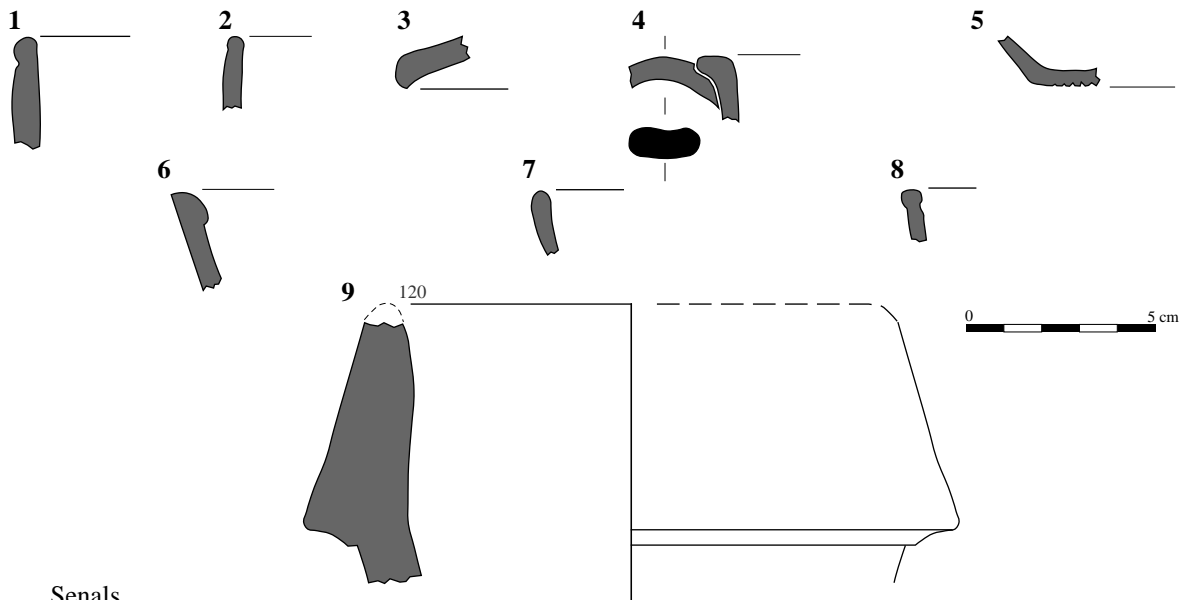

Senals

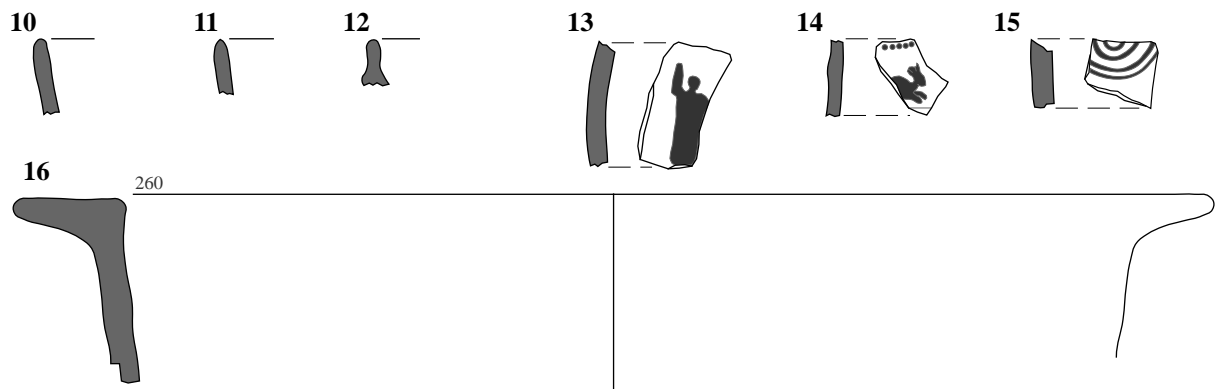

Paladell

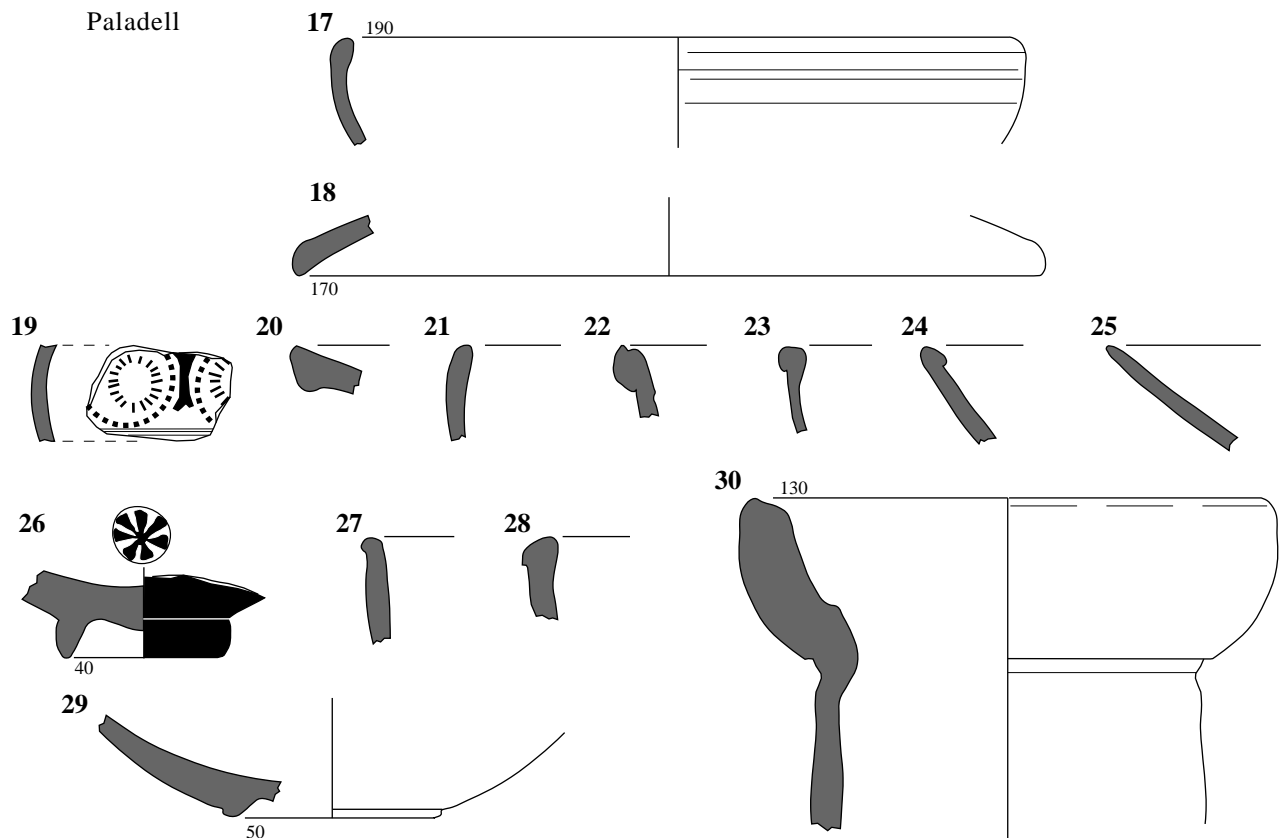

Làm. 5: Material ceràmic d'època tardorepublicana i imperial dels jaciments de Senals [3], Vall de Porcs [7] i Paladell [8] (Riba-roja).

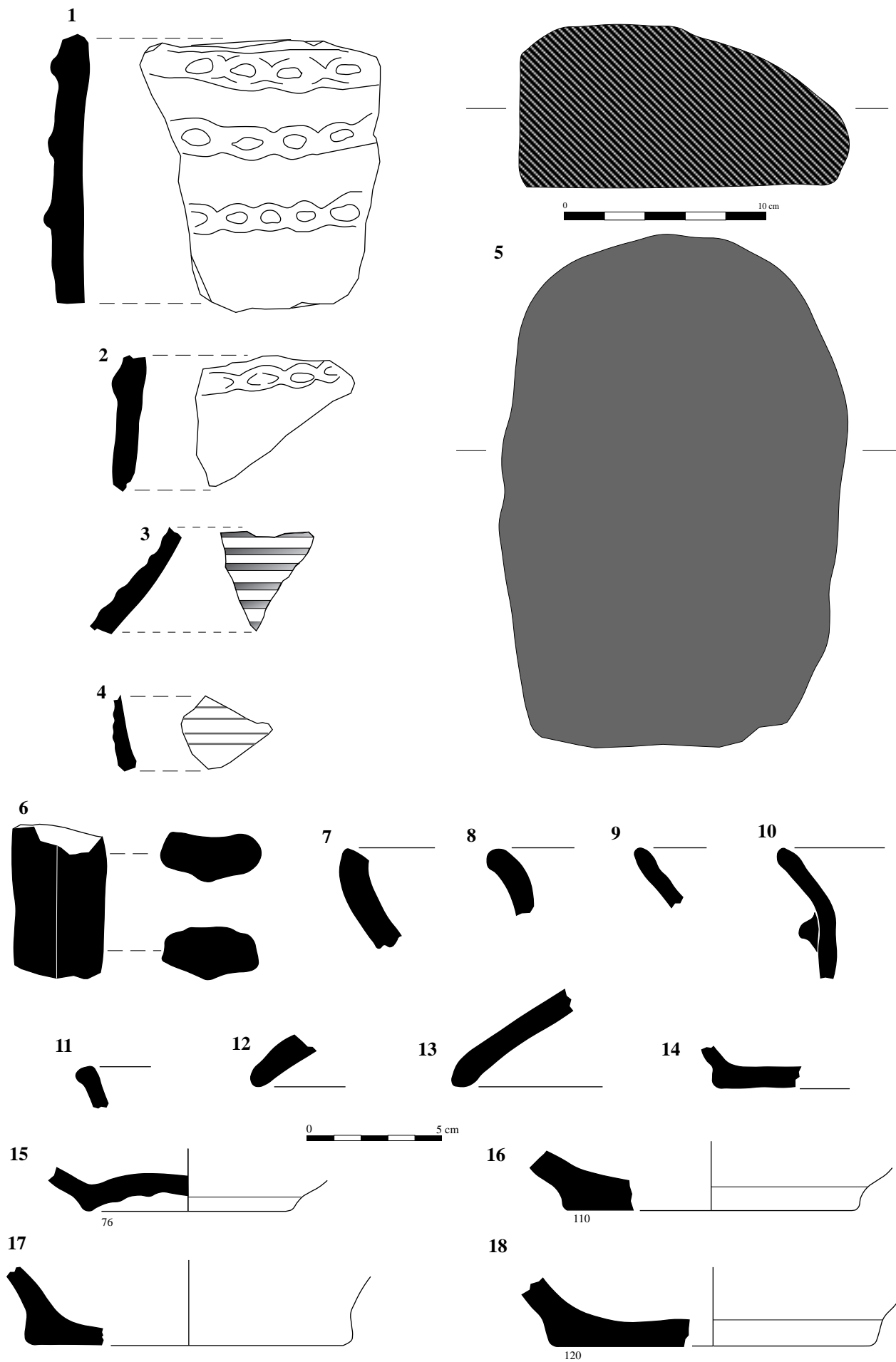

Làm. 6: Ceràmica a mà i moli de granit dels Castellons 2 [1] (Riba-roja).



Magalanya

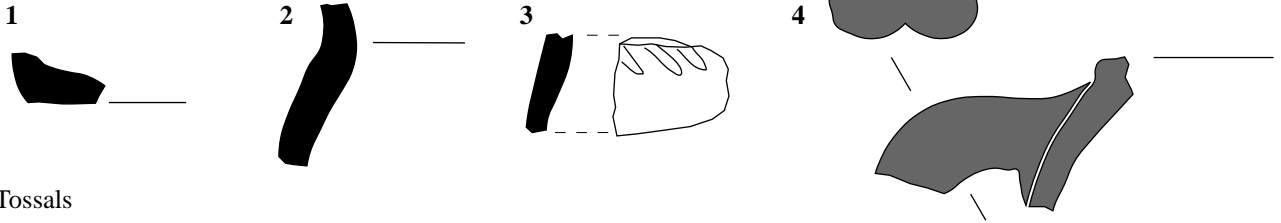

Tossals

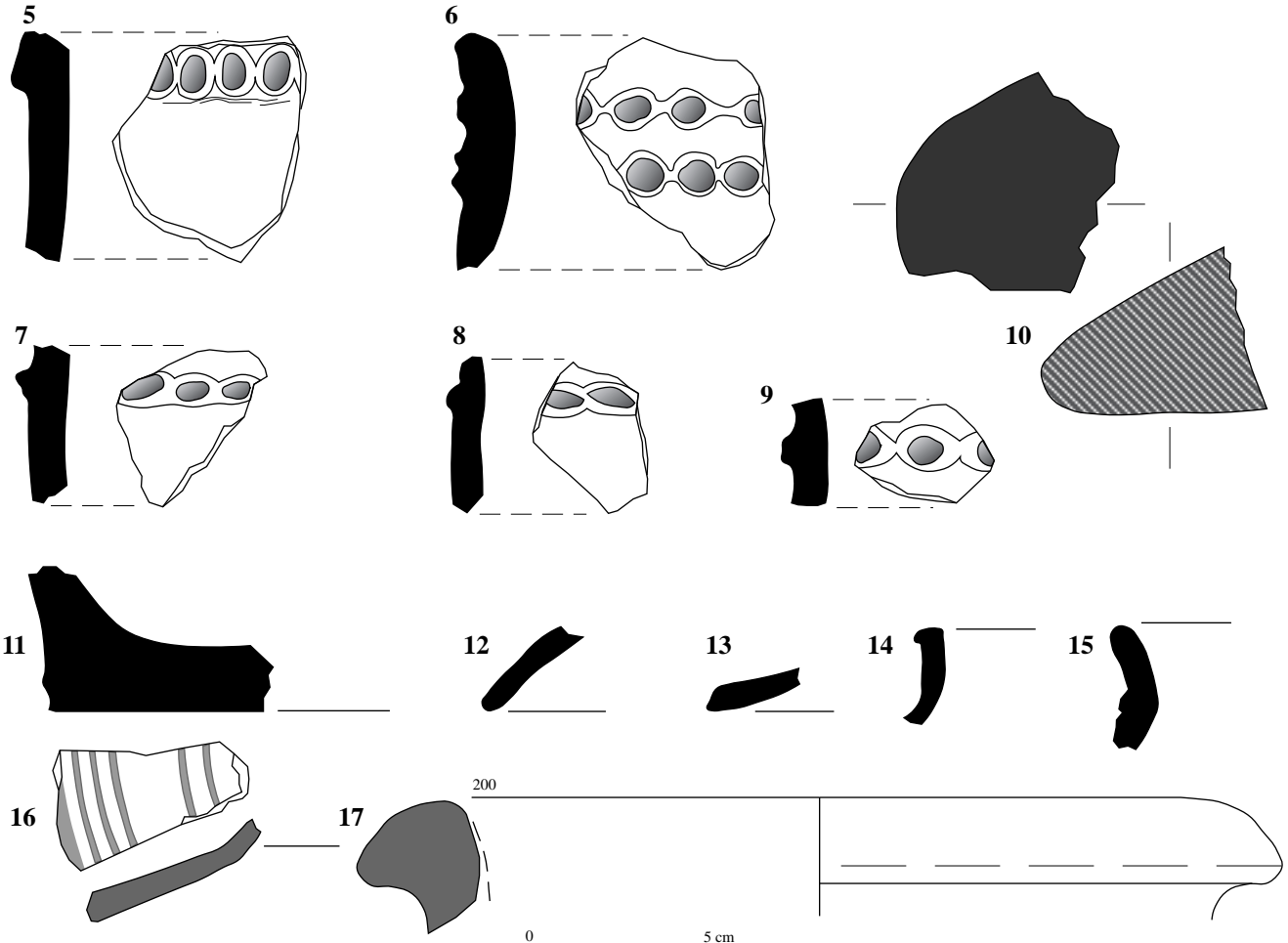

Roca de la Bruixeta

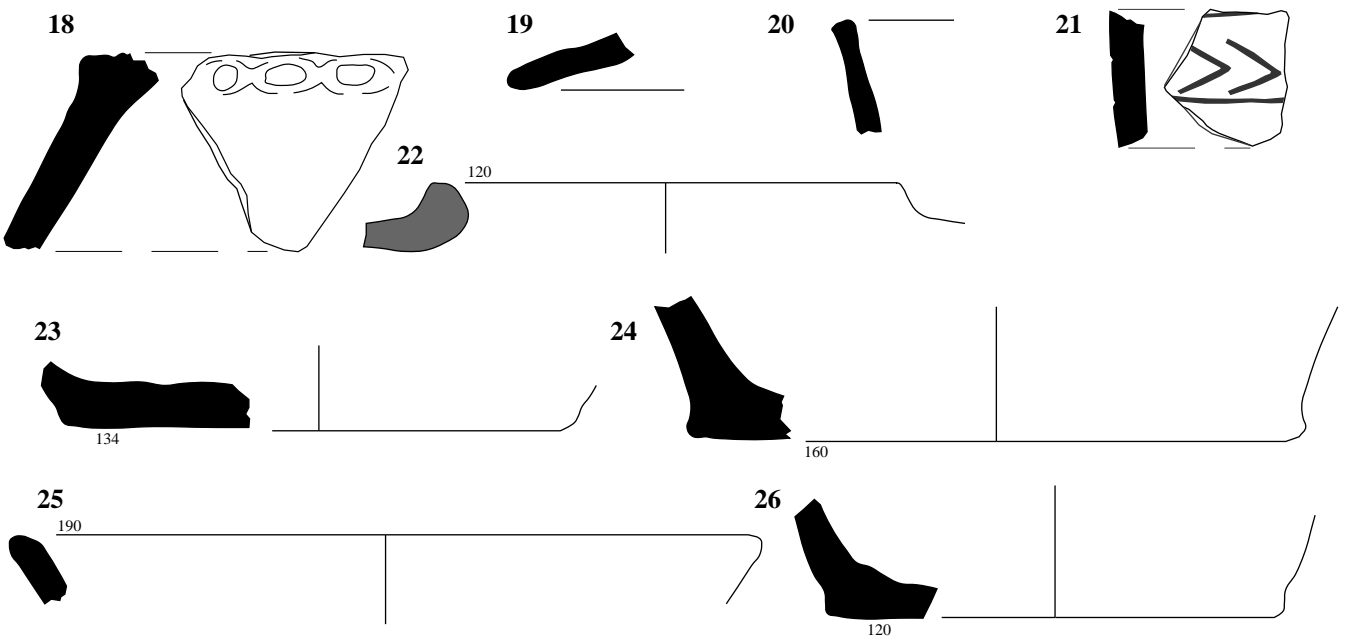

Làm. 7: Materials arqueològics dels jaciments de Magalanya [6] (Riba-roja), Tossals [18] (Vinebre), i Roca de la Bruixeta [20] (Vinebre).

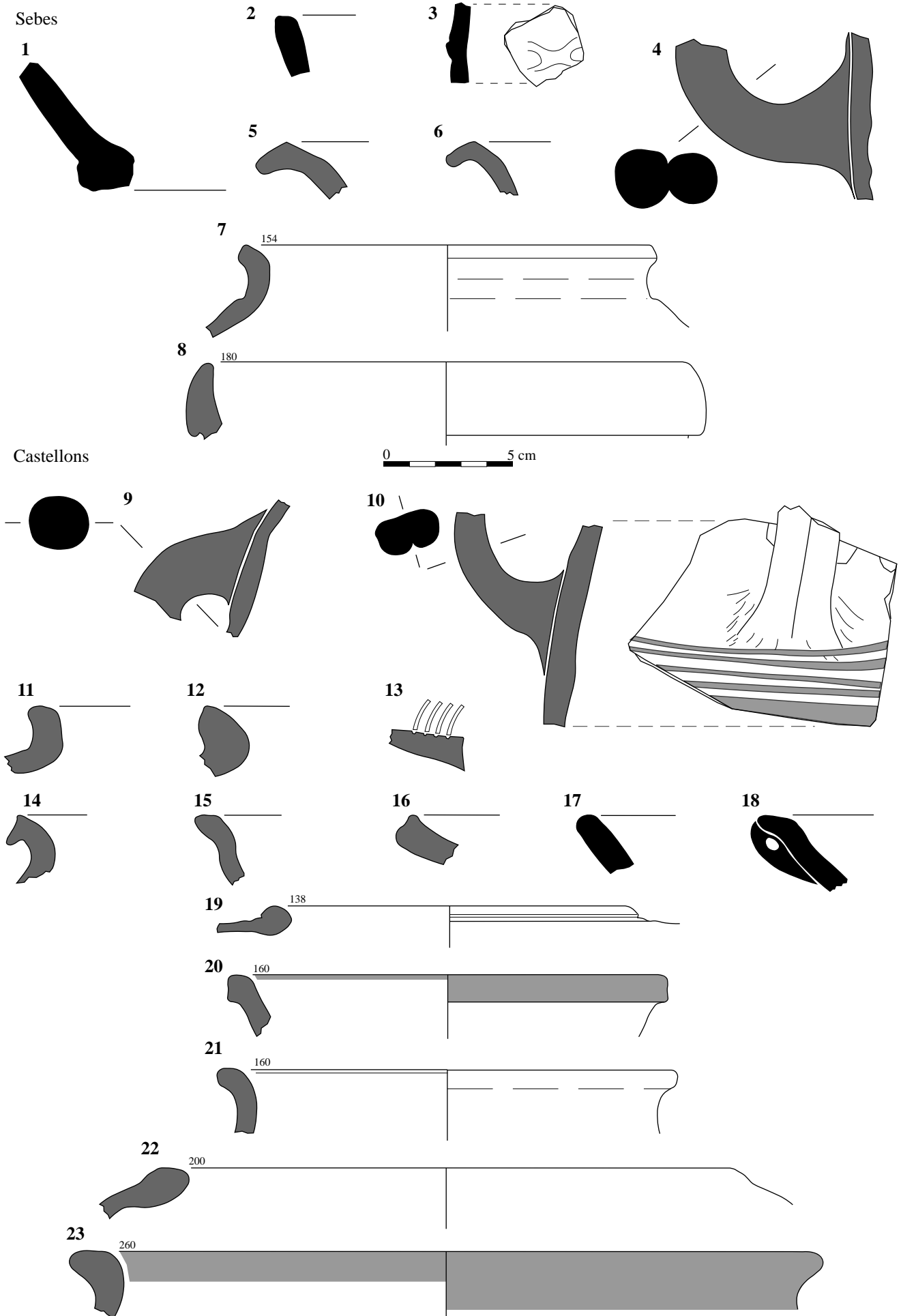

Làm. 8: Materials ceràmics a mà i a torn dels jaciments de Sebes [12] i Castellons [14] (Flix).

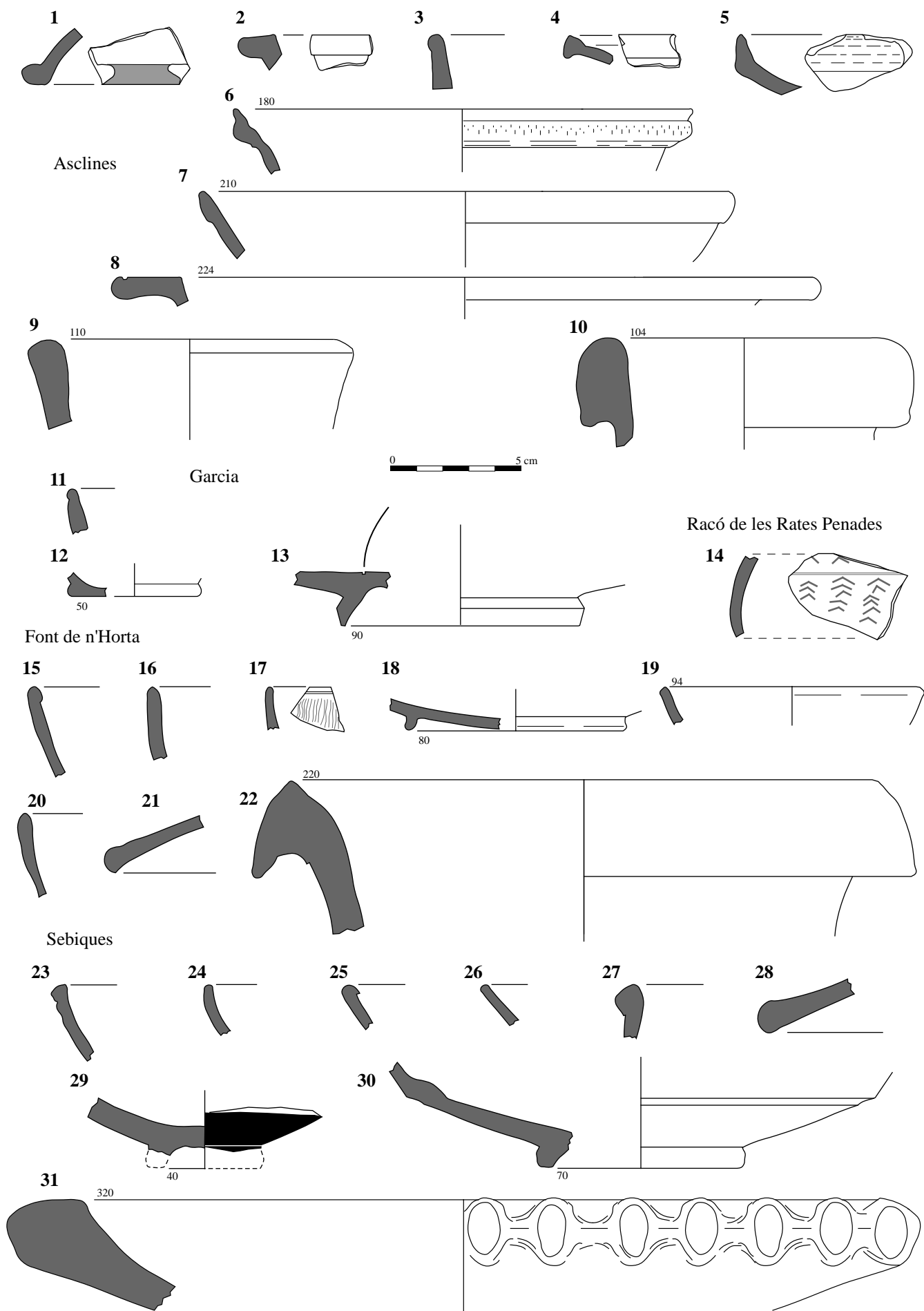

Làm. 9: Materials ceràmics tardorepublicans i imperials dels jaciments d'Asclines [29] (Ascó), Garcia [40] (Garcia), Racó de les Rates Penades [19] (Vinebre), Font de n'Horta [21] (Torre de l'Espanyol), i Sebiques [22] (Vinebre).

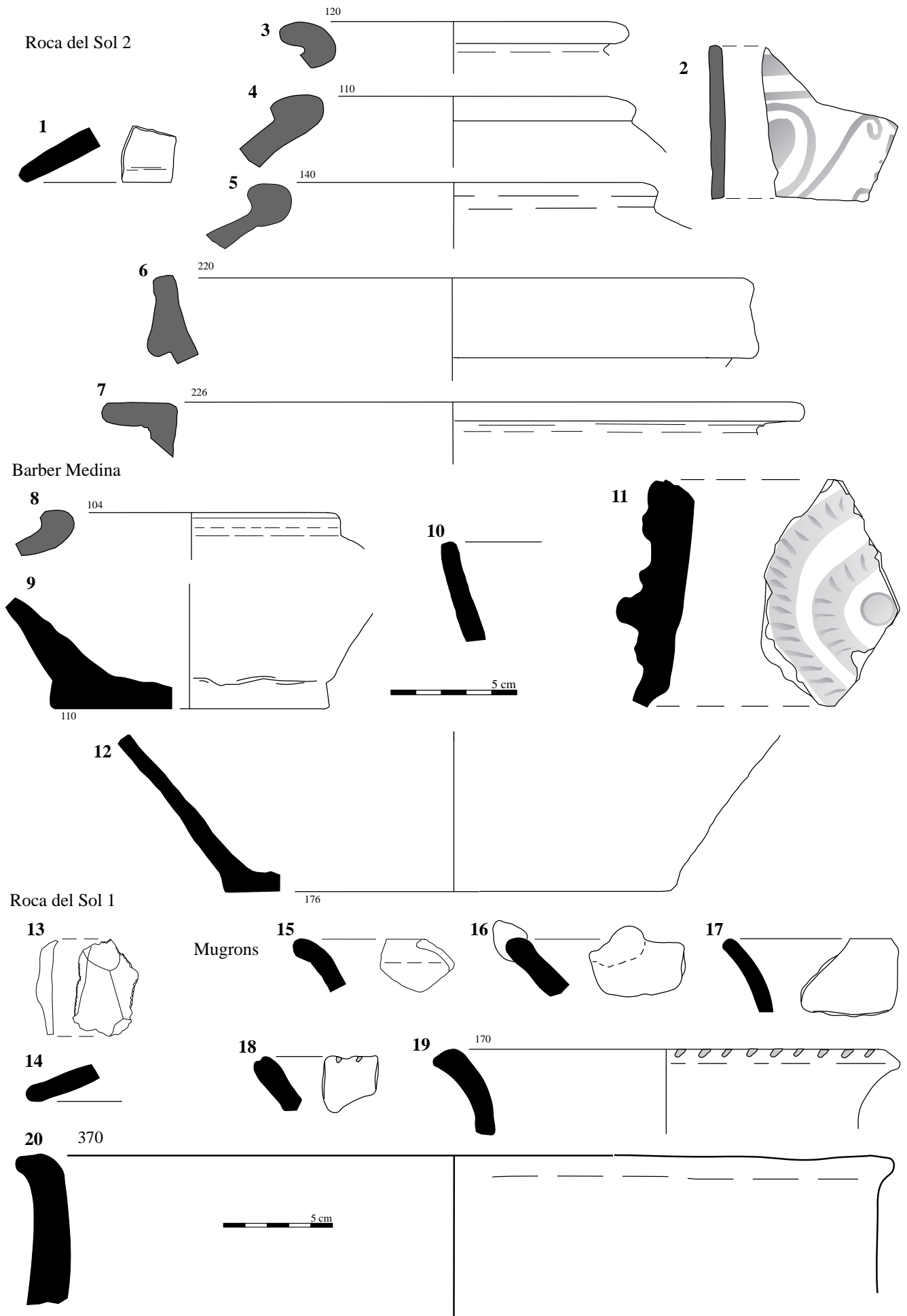

Làm. 10: Materials arqueològics dels jaciments de la Roca del Sol 2 [26], Roca del Sol 1 [25] (Garcia), Barber Medina [31] i els Mugrons [32] (Ascó).

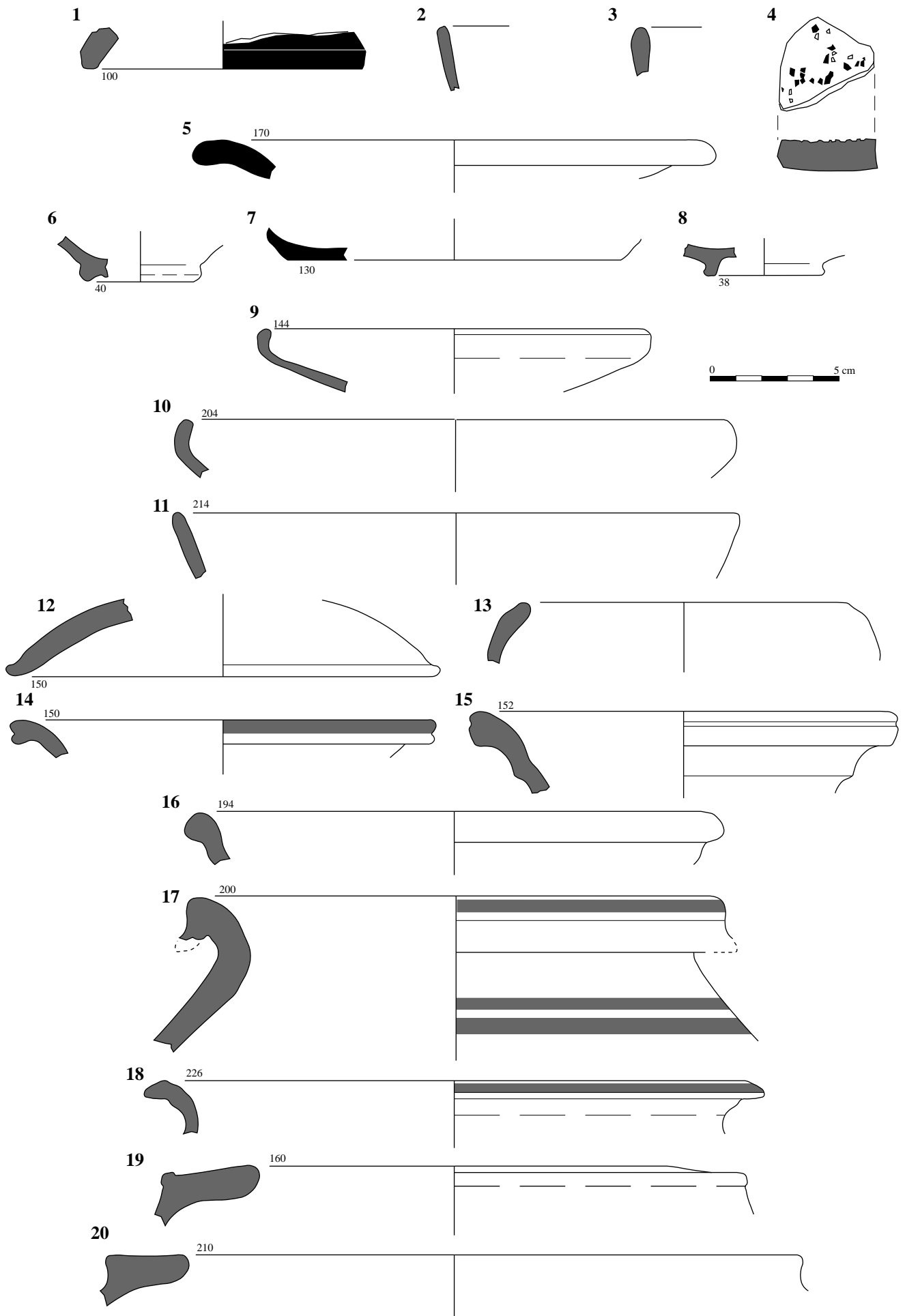

Làm. 11: Ceràmica a torn i a mà del jaciment de Forn Teuler [28] (Ascó).

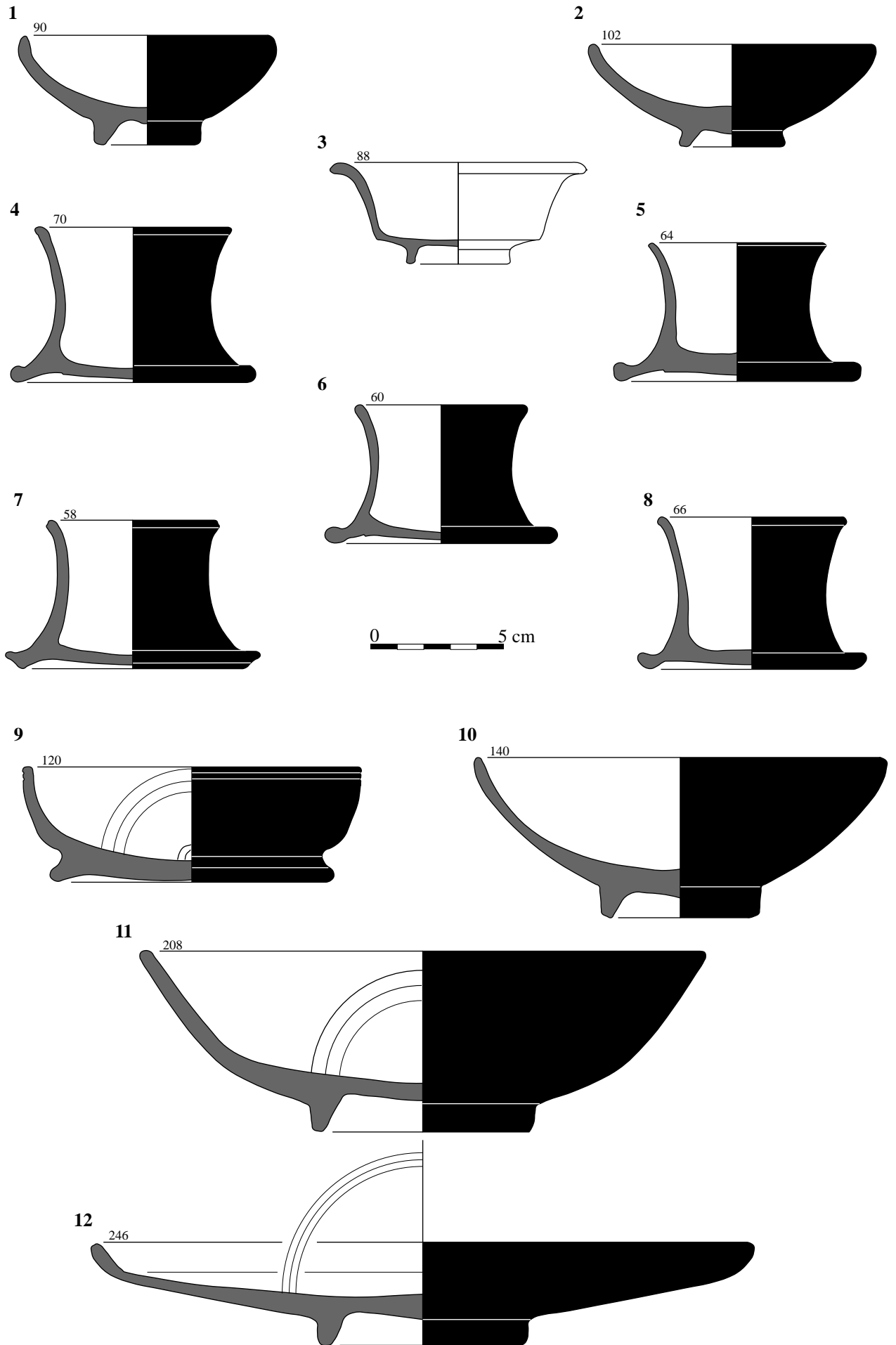

Làm. 12: Ceràmiques campanianes i imitació ibèrica del jaciment de la Serra de l'Espasa [39] (Capçanes).



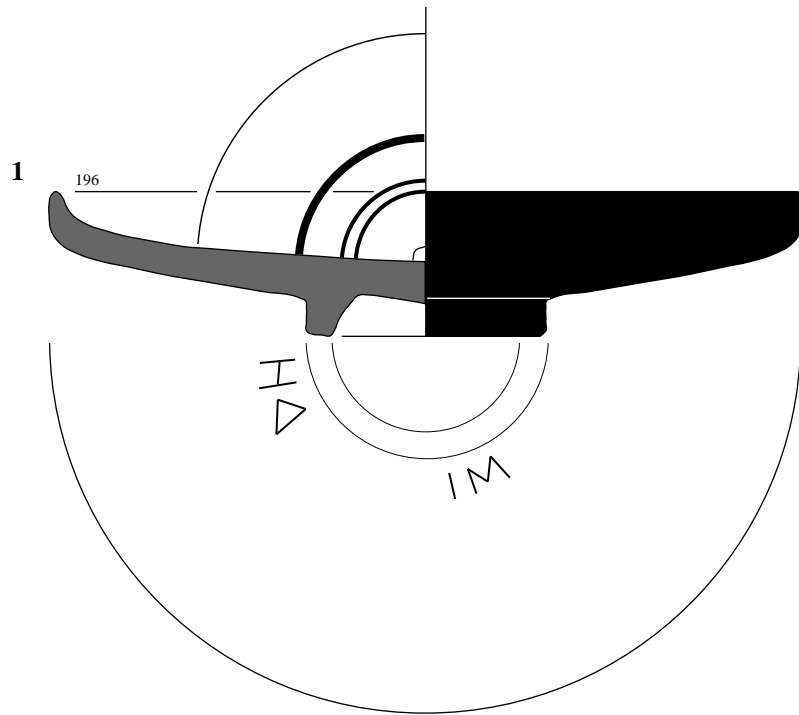

0 5 cm

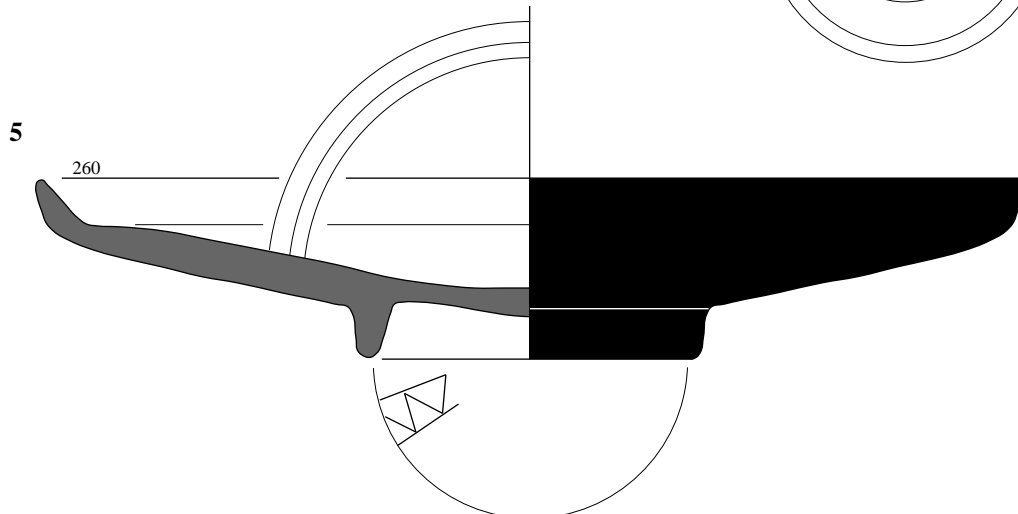
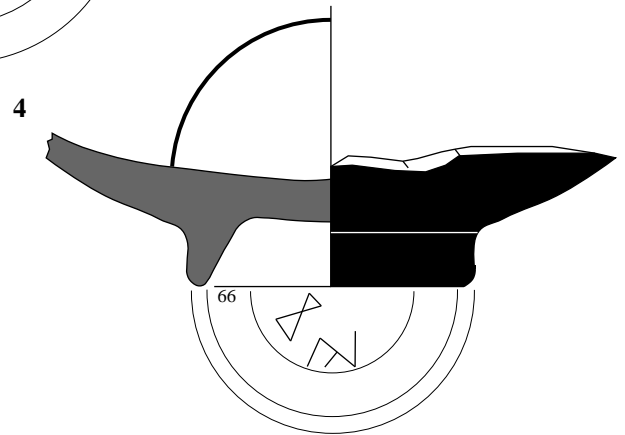
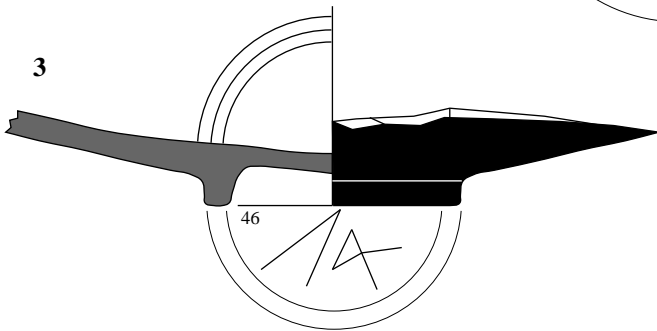
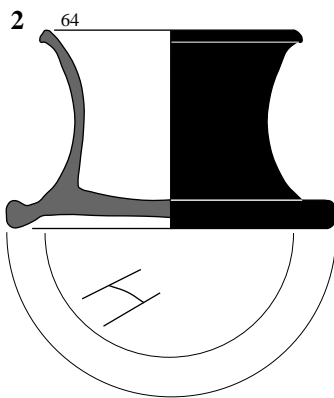

Làm. 13: Ceràmiques campanianes amb grafitis ibèrics de la Serra de l'Espasa [39] (Capçanes).

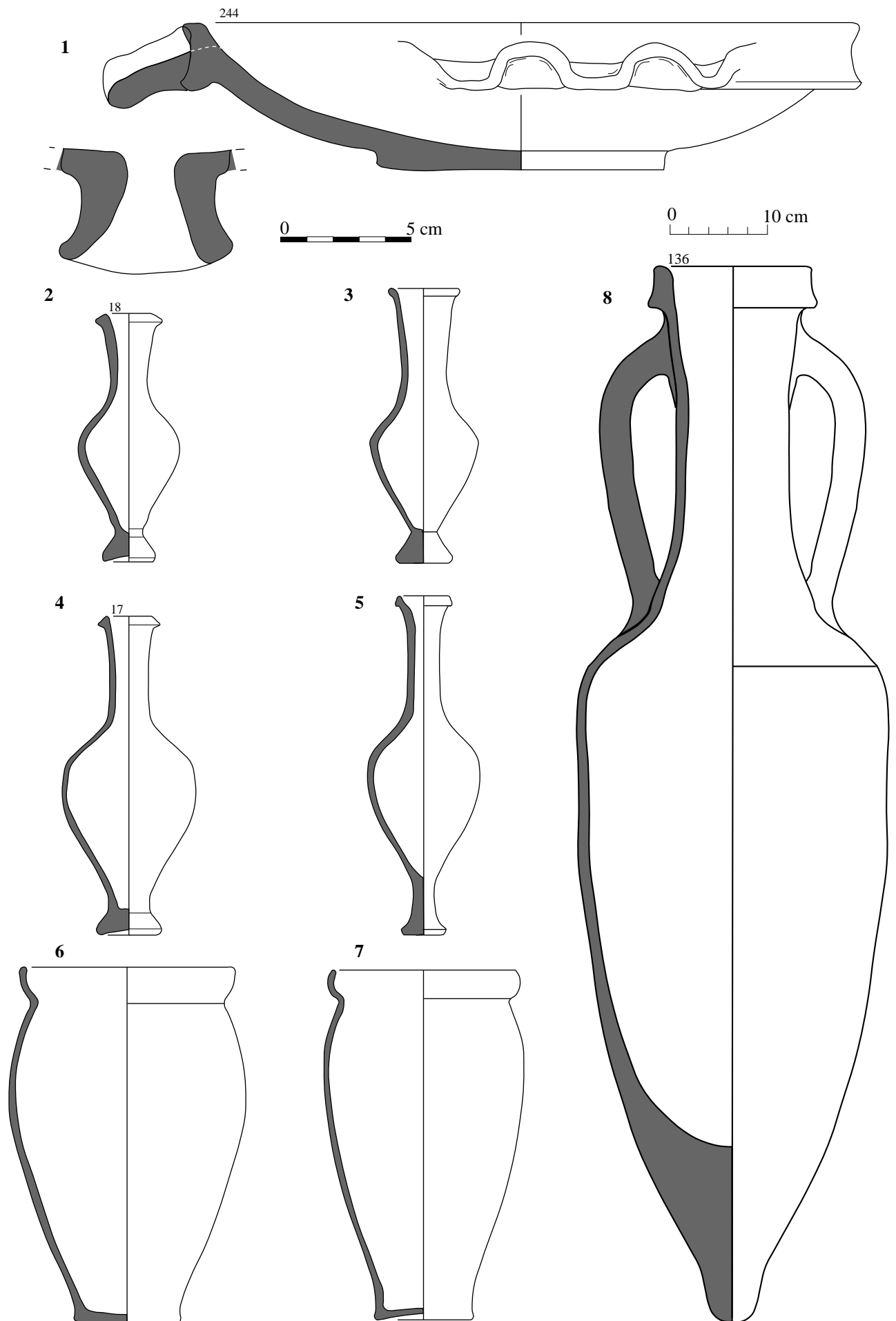

Làm. 14: Morter i àmfora itàlics, ungüentaris i ceràmica de parets fines del jaciment de la Serra de l'Espasa [39] (Capçanes).

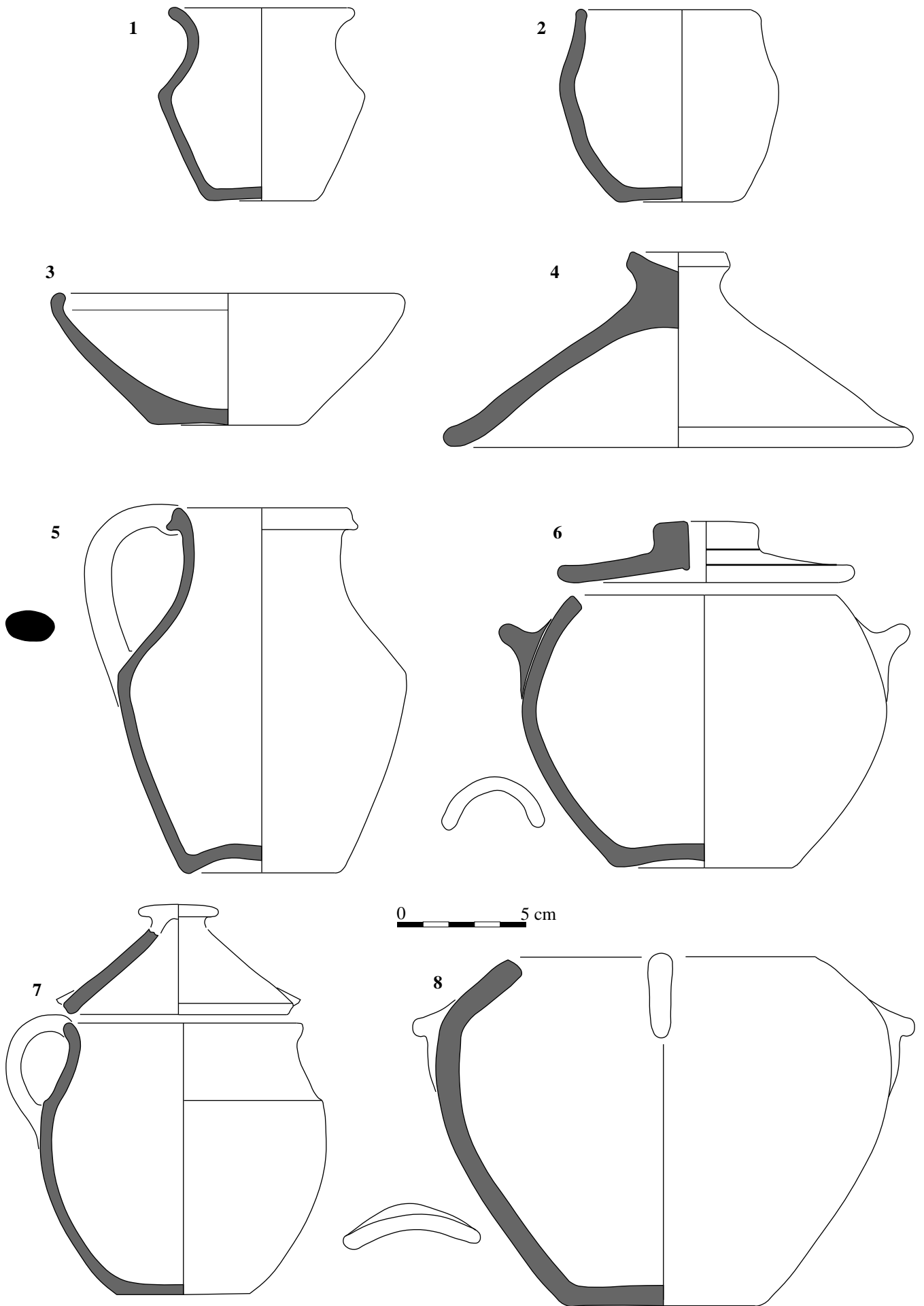

Làm. 15: Ceràmiques de cuina del jaciment de la Serra de l'Espasa [39] (Capçanes).

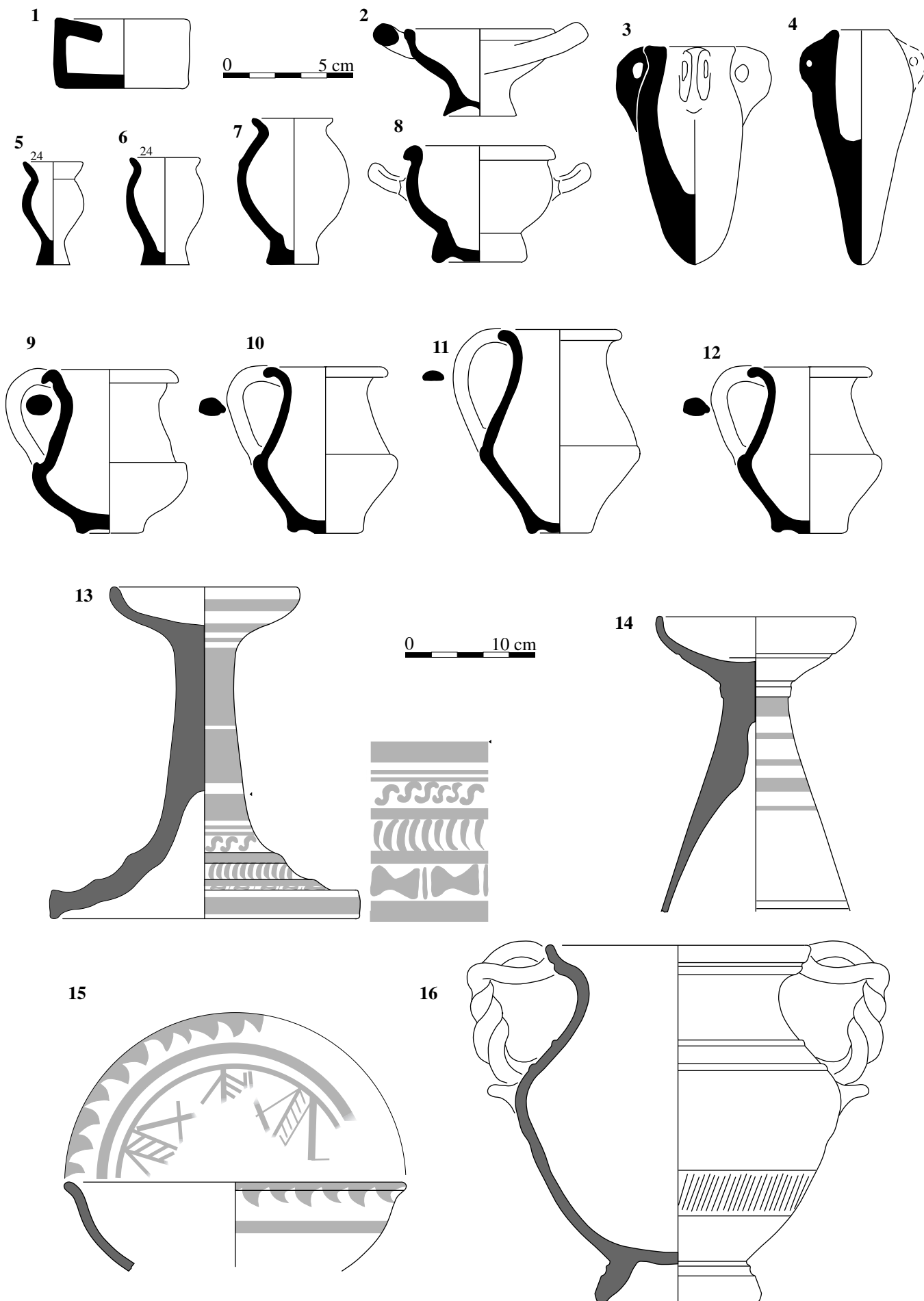

Lam. 16: Peces petites a mà, ceràmica grisa i ceràmica ibèrica oxidada del jaciment de la Serra de l'Espasa [39] (Capçanes).

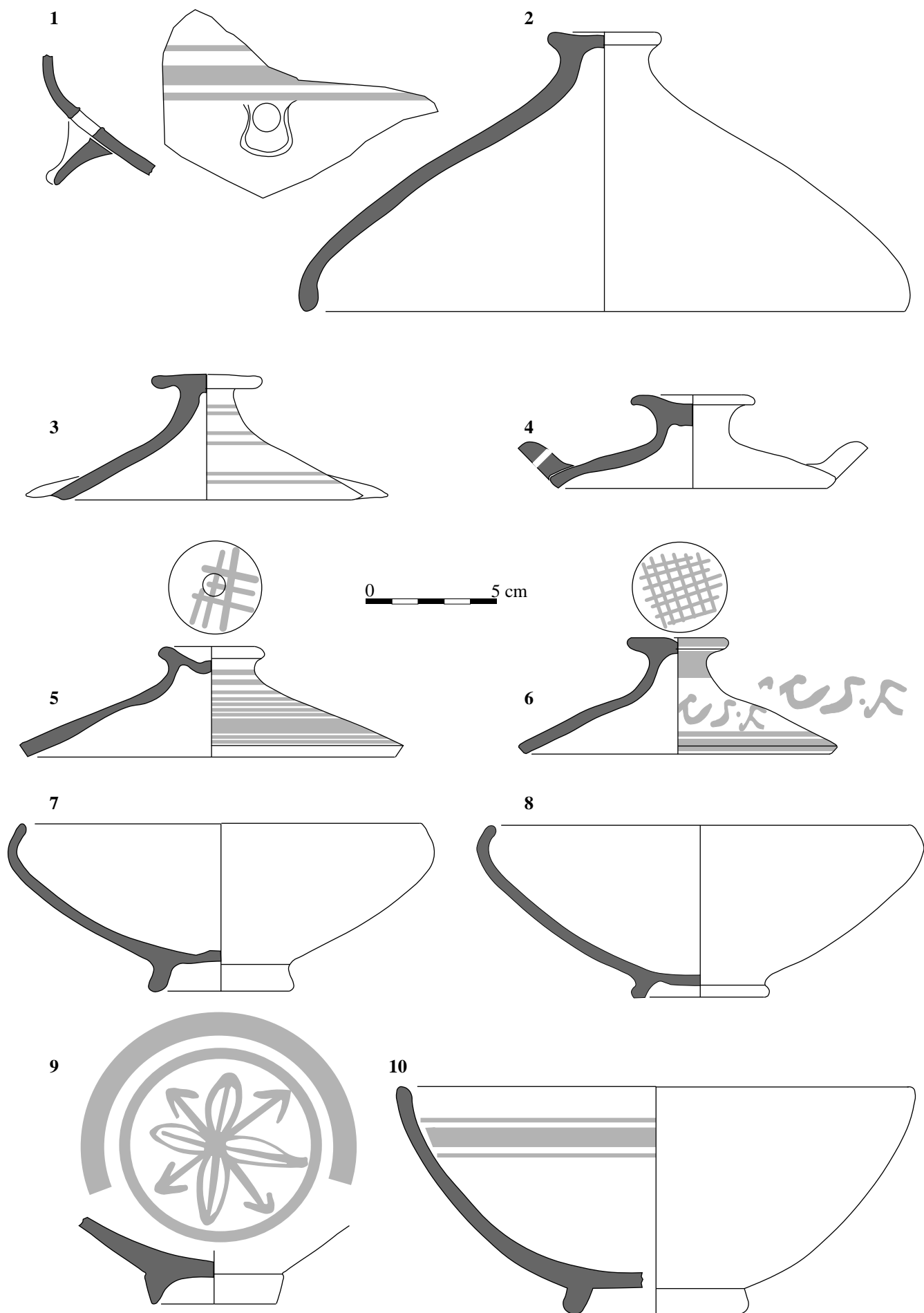

Làm. 17: Ceràmica ibèrica oxidada del jaciment de la Serra de l'Espasa [39] (Capçanes).

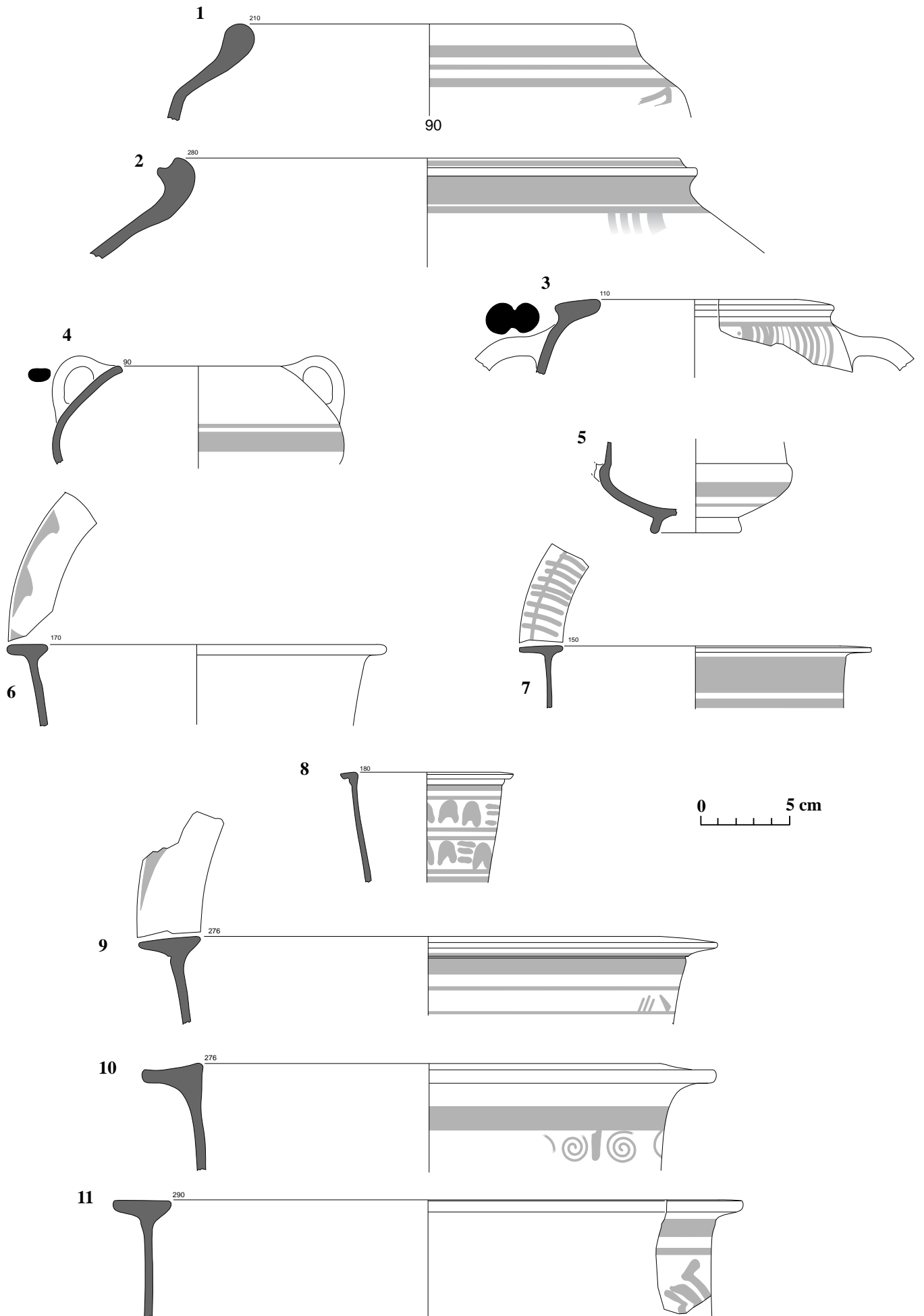

Làm. 18: Ceràmica ibèrica pintada de la Serra de l'Espasa [39] (Capçanes).



1:2

0 10 cm

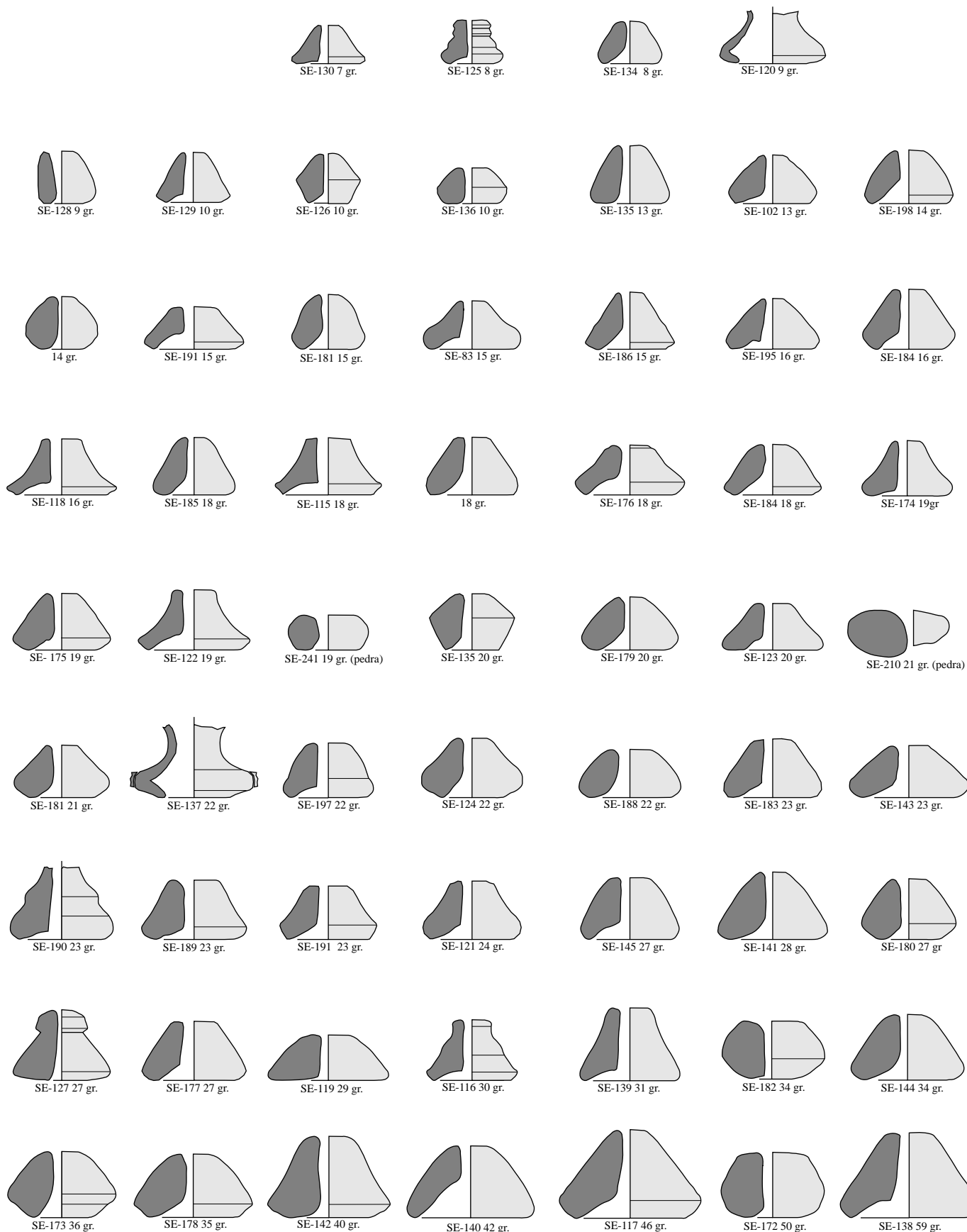

Làm. 19: Fusaioles de la Serra de l'Espasa [39] Capçanes.

1:2

0

10 cm

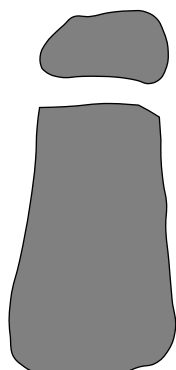

SE-85 495 gr.

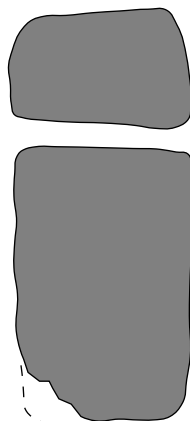

SE-100 500 gr.

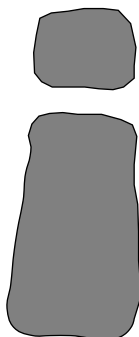

SE-102 290 gr.

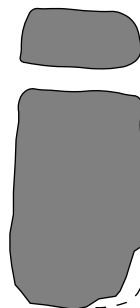

SE-87 230 gr.

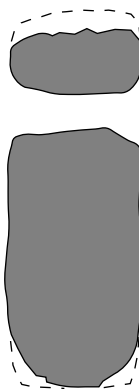

SE-99 400 gr.

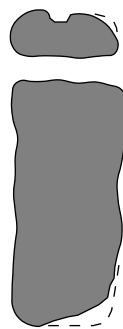

SE-86 217 gr.

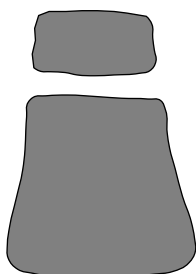

SE-79 280 gr.

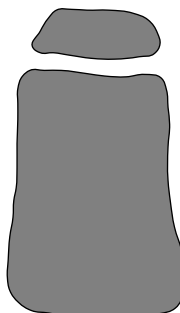

SE-178 275 gr.



Làm. 20: *Pondera* de la Serra de l'Espasa [39] Capçanes.



SE-103 440 gr.

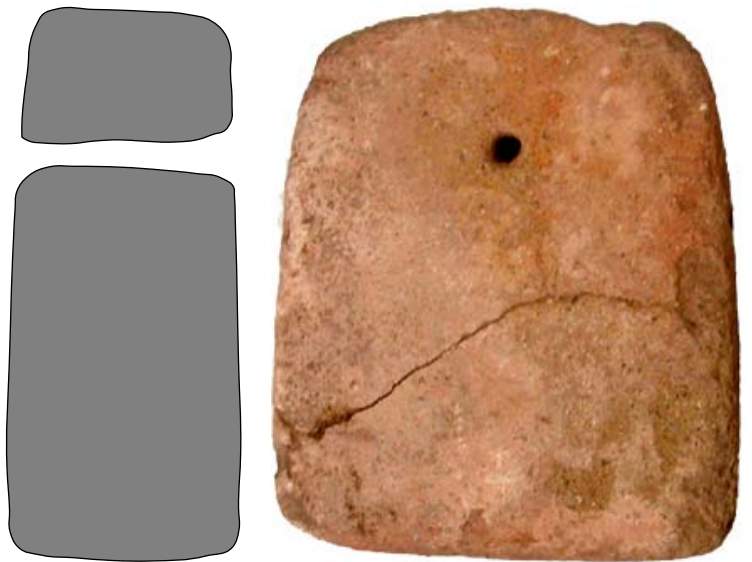

SE-46 3180 gr.



SE-112 2690 gr.

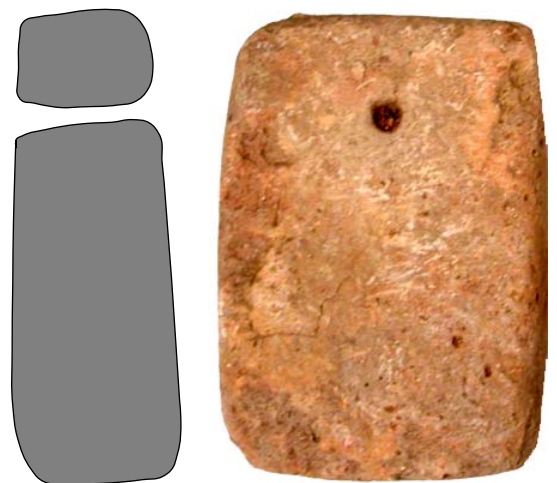

SE-104 2155 gr.

1:2 0 10 cm



SE-114



SE-193

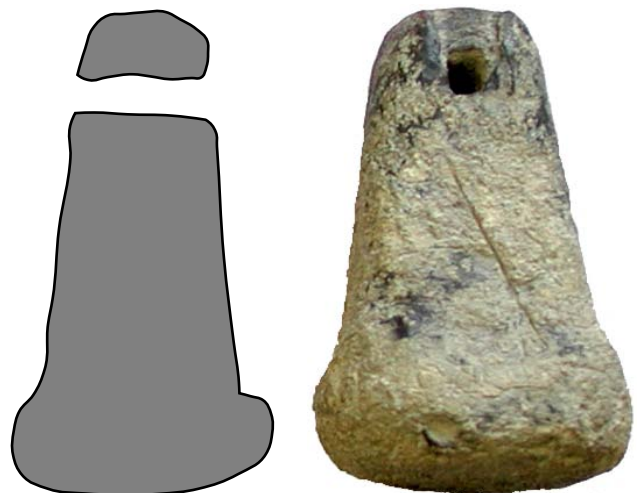

SE-229 440 gr.

Làm. 21: *Pondera* de la Serra de l'Espasa [39] Capçanes.



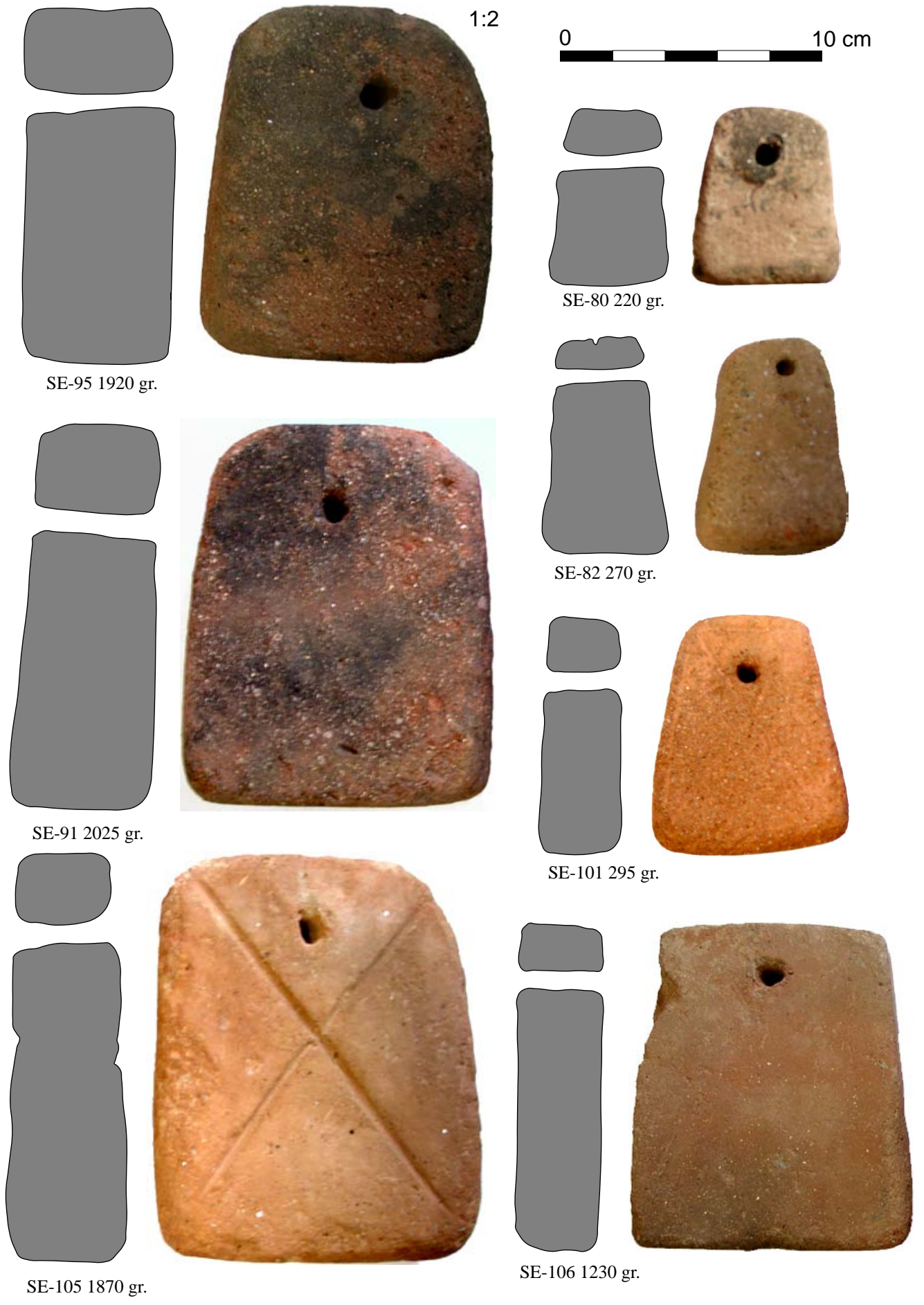

Làm. 22: Pondera de la Serra de l'Espasa [39] Capçanes.

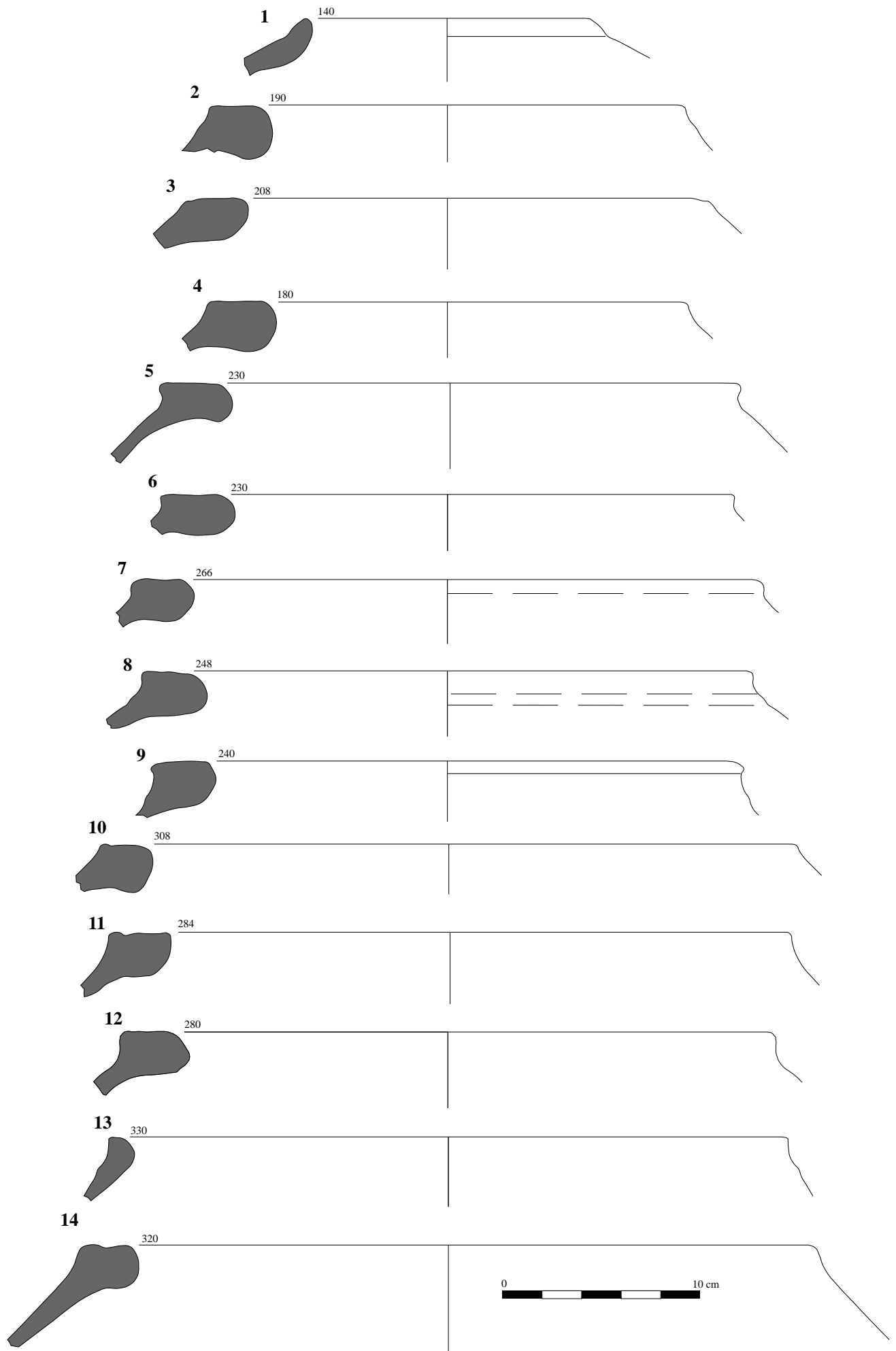

Làm. 23: Vores de grans tenalles a torn de la Serra de l'Espasa [39] Capçanes.

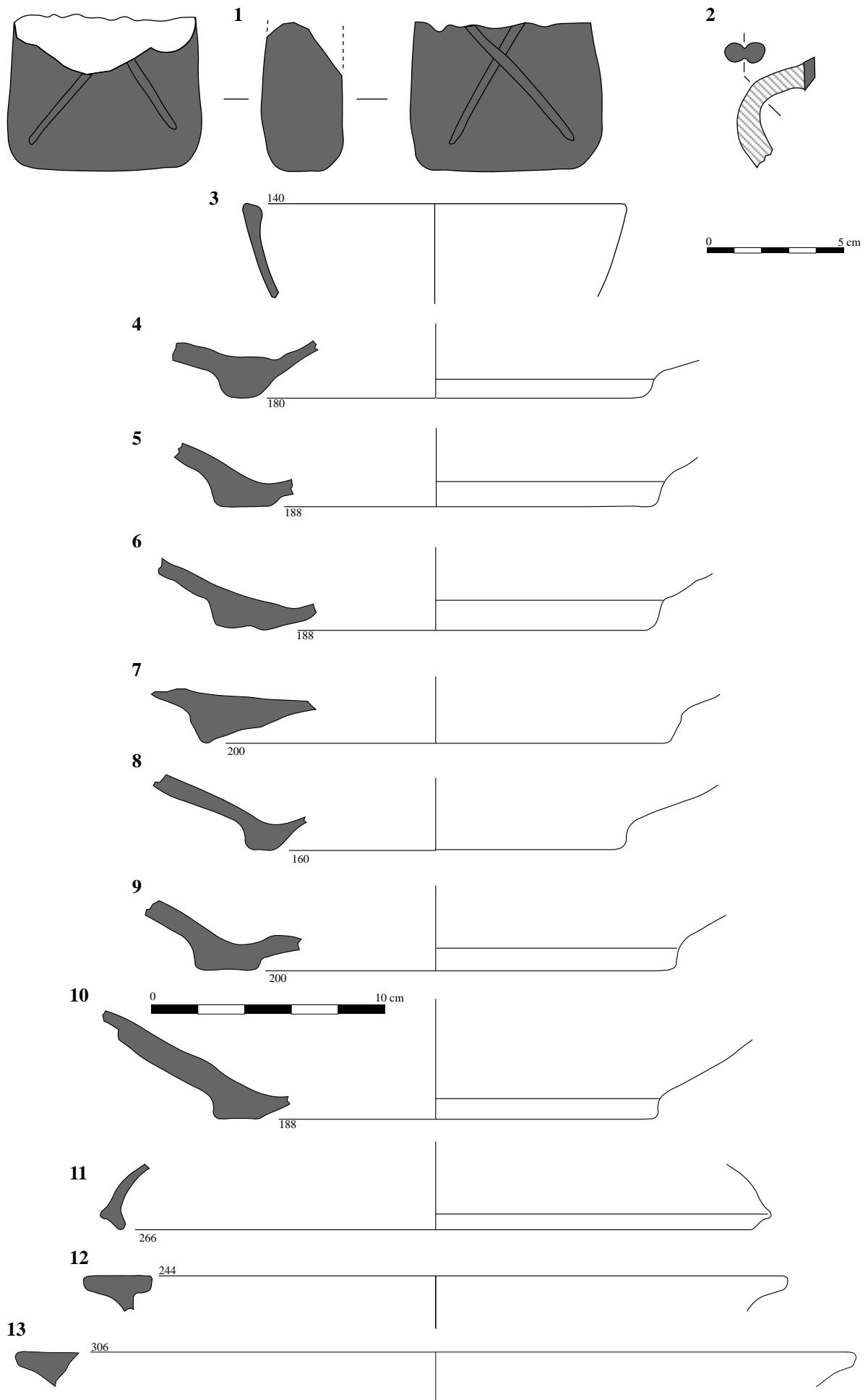

Làm. 24: *Pondus*, nansa de campaniana A, bases de grans tenalles i vores de *kalathoi* de la Serra de l'Espasa [39] Capçanes.



Serra de l'Espasa (dalt)

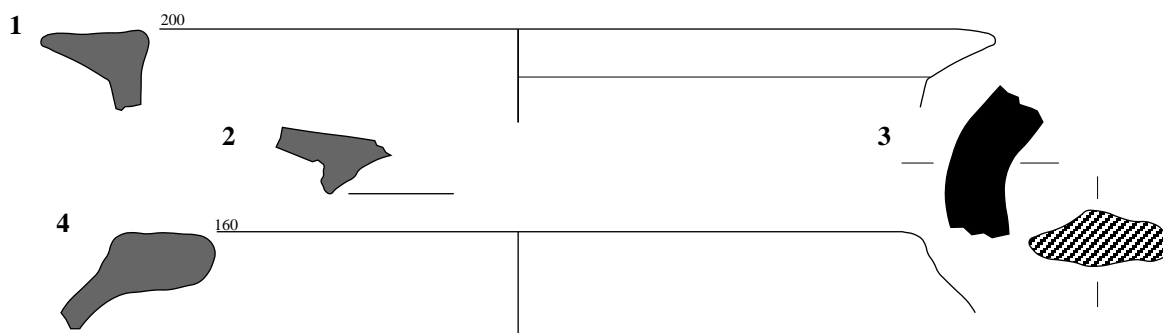

Quatre Camins

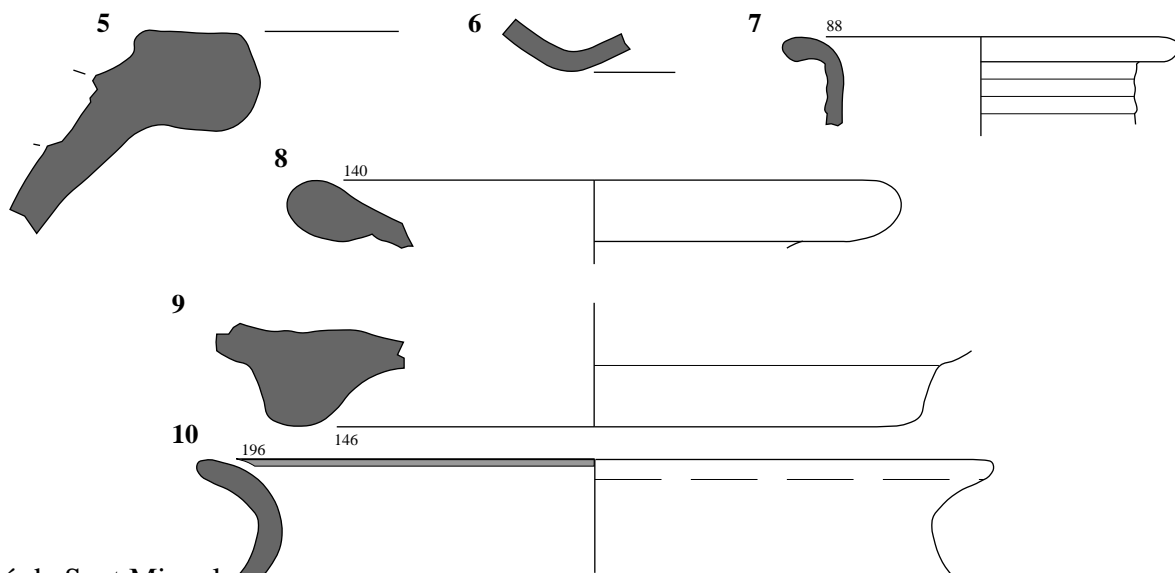

Racó de Sant Miquel

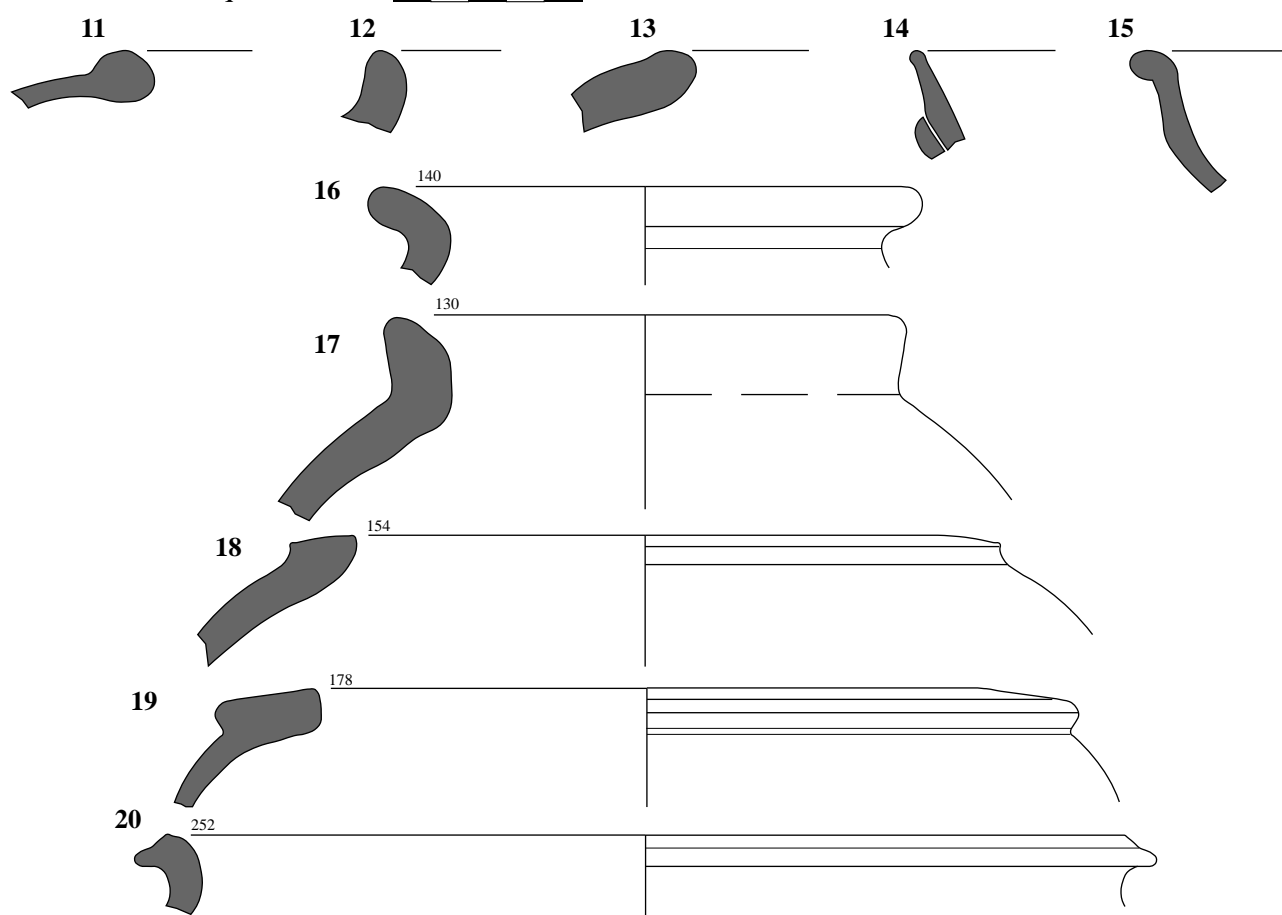

Làm. 25: Material arqueològic de la zona superior de la Serra de l'Espasa [39] (Capçanes), de Quatre Camins [45] (Benissanet), i del Racó de Sant Miquel [27] (Vinebre).

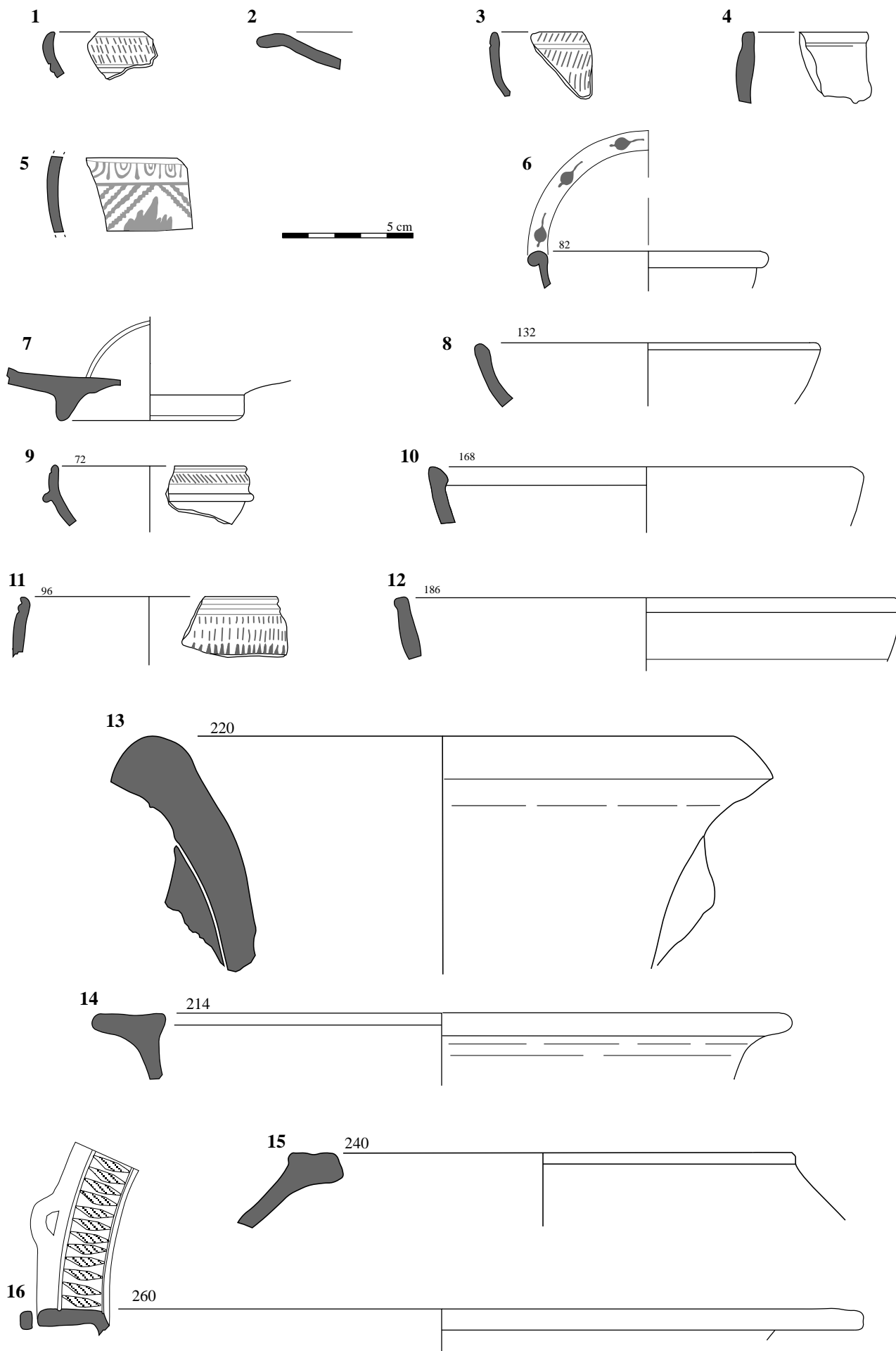

Làm. 26: Ceràmiques de l'Alt Imperi de les Planes [41] Móra la Nova.

Cases Barates

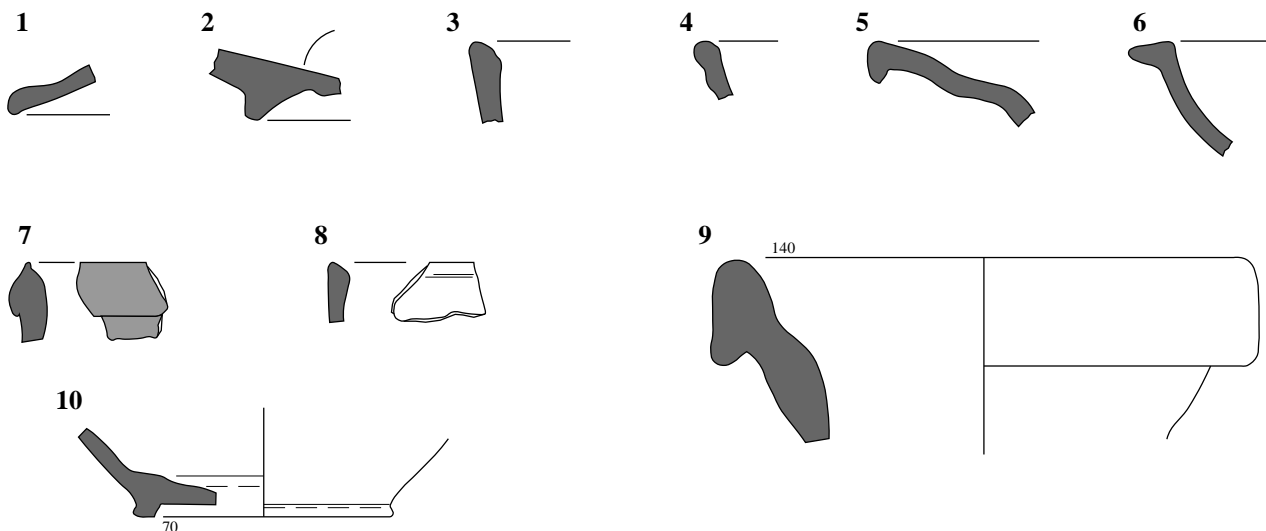

Les Pedres

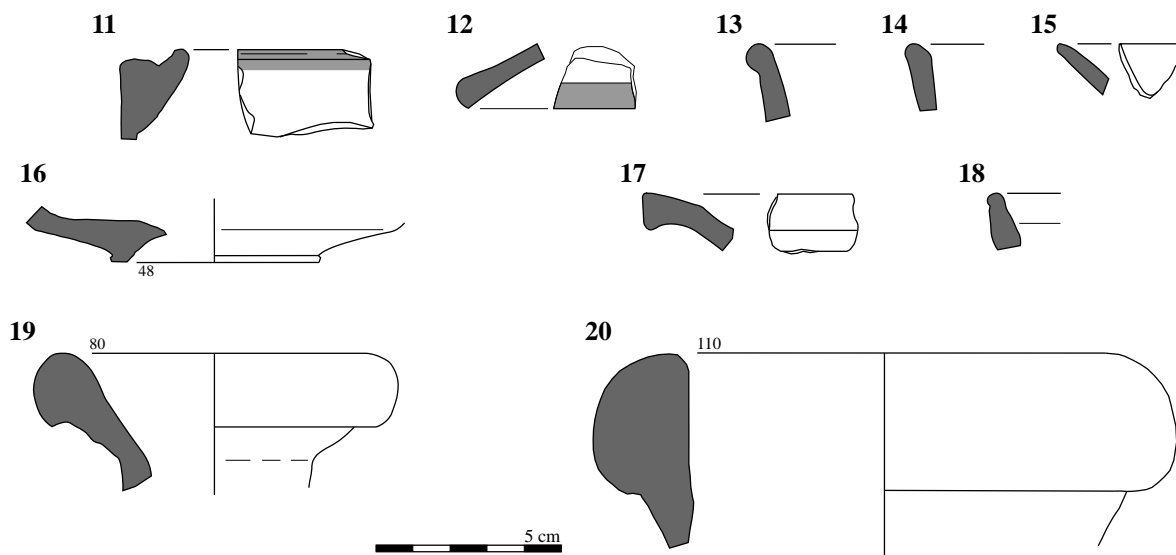

Barranc Fondo

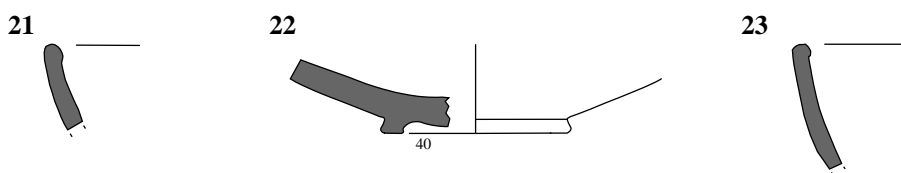

Sant Vicenç

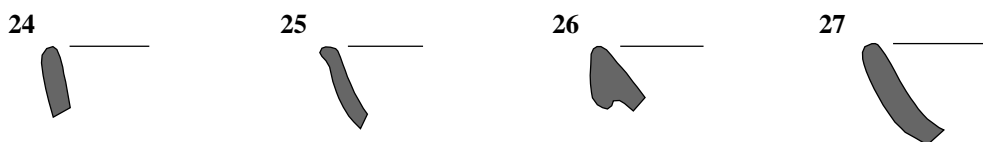

Les Deveses



Làm. 27: Material imperial dels jaciments de les Cases Barates [42] (Móra la Nova), les Pedres [73] (Ginestar), Barranc Fondo [52] (Tivissa), Sant Vicenç [74] (Ginestar) i les Deveses 2 [68] (Ginestar).

Ligallo de Lixem

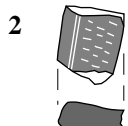
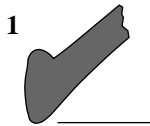

Emportells

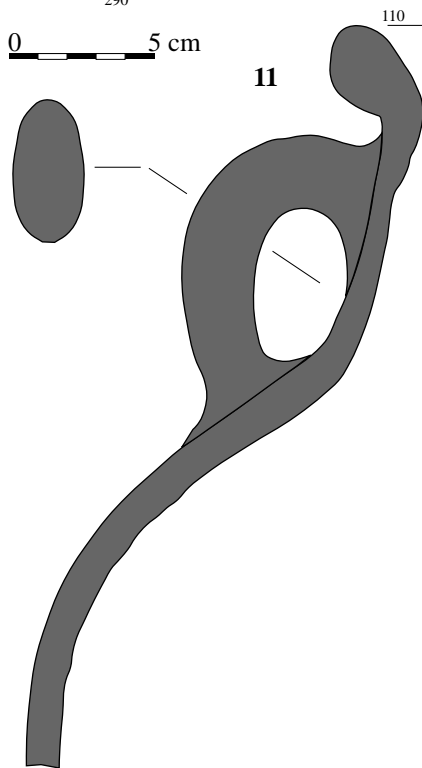
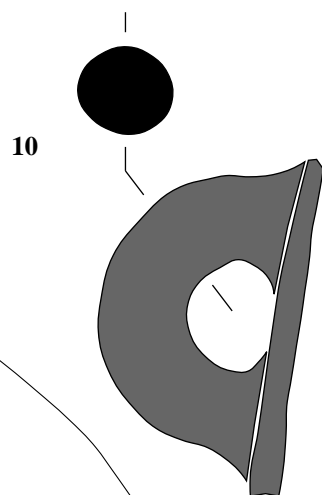
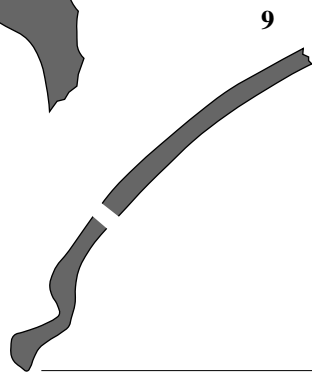
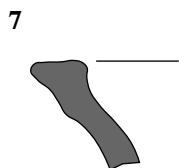
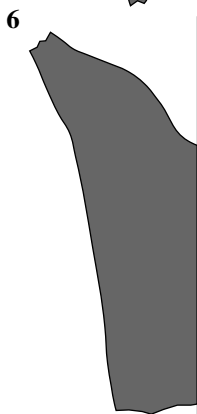
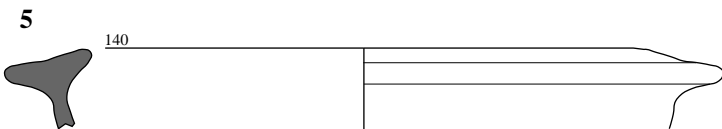
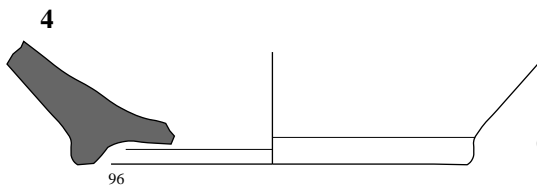

Làm. 28: Ceràmiques altimperials del Ligallo de Lixem [91] (Benifallet) i dels Emportells [44] (Benissanet).

Barranc de Gàfols 2



1

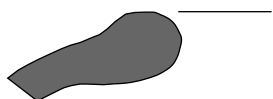

2

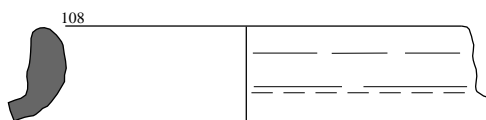

3

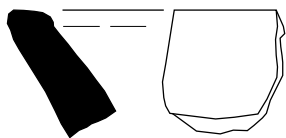

4

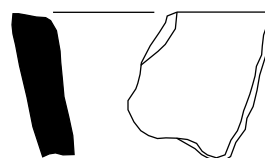

Lo Quiquet

Granges de Ginestar

5



6



Mas de Giralt

7

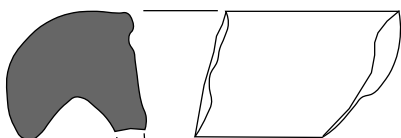

8

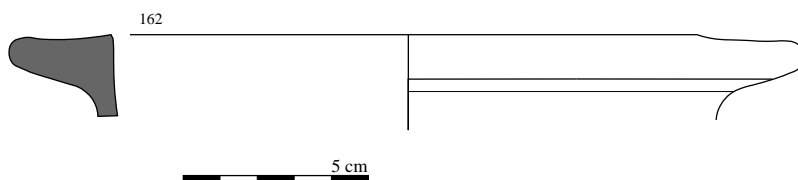

Les Deveses 1

9

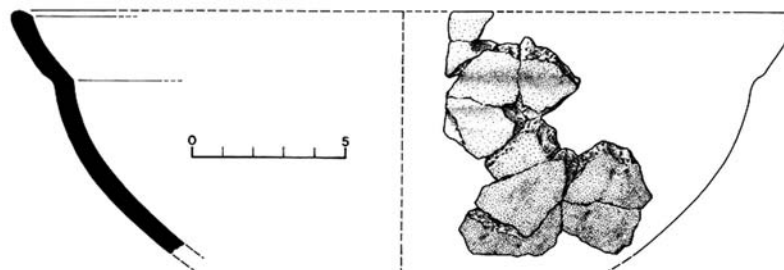

10

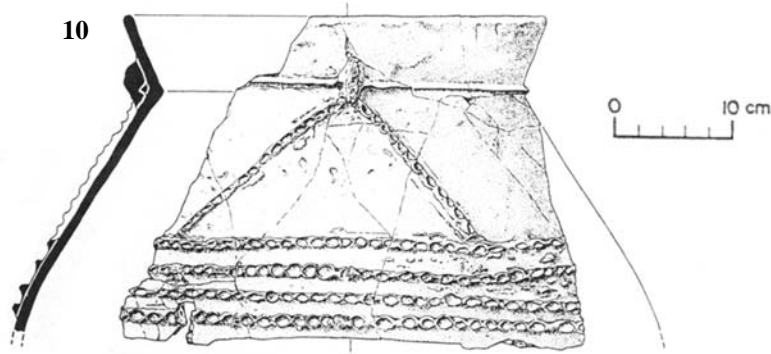

Làm. 29: Material ceràmic a mà i a torn dels jaciments del Barranc de Gàfols 2 [66] (Ginestar), lo Quiquet [75] (Tivissa), mas de Giralt [46] (Móra la Nova), Granges de Ginestar [64] i les Deveses 1 [67] (Ginestar).



Làm. 30: Grans contenidors ceràmics ibèrics del Mas de Molló 1 [48] (Móra la Nova).



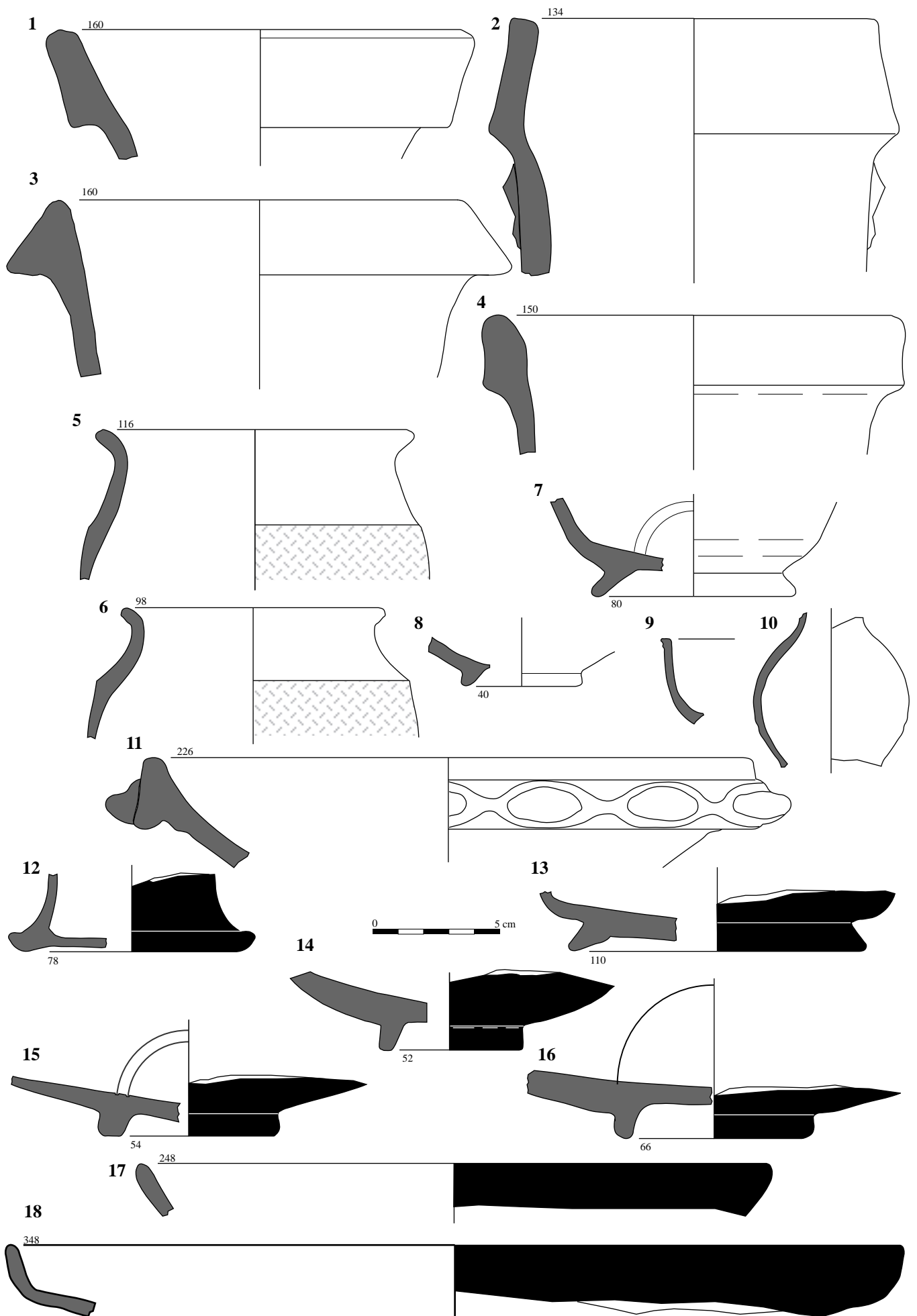

Làm. 31: Àmfores romanes, vaixel·la campaniana, ceràmica de cuina, i ceràmica ibèrica del Mas de Molló 1 [48] (Móra la Nova).

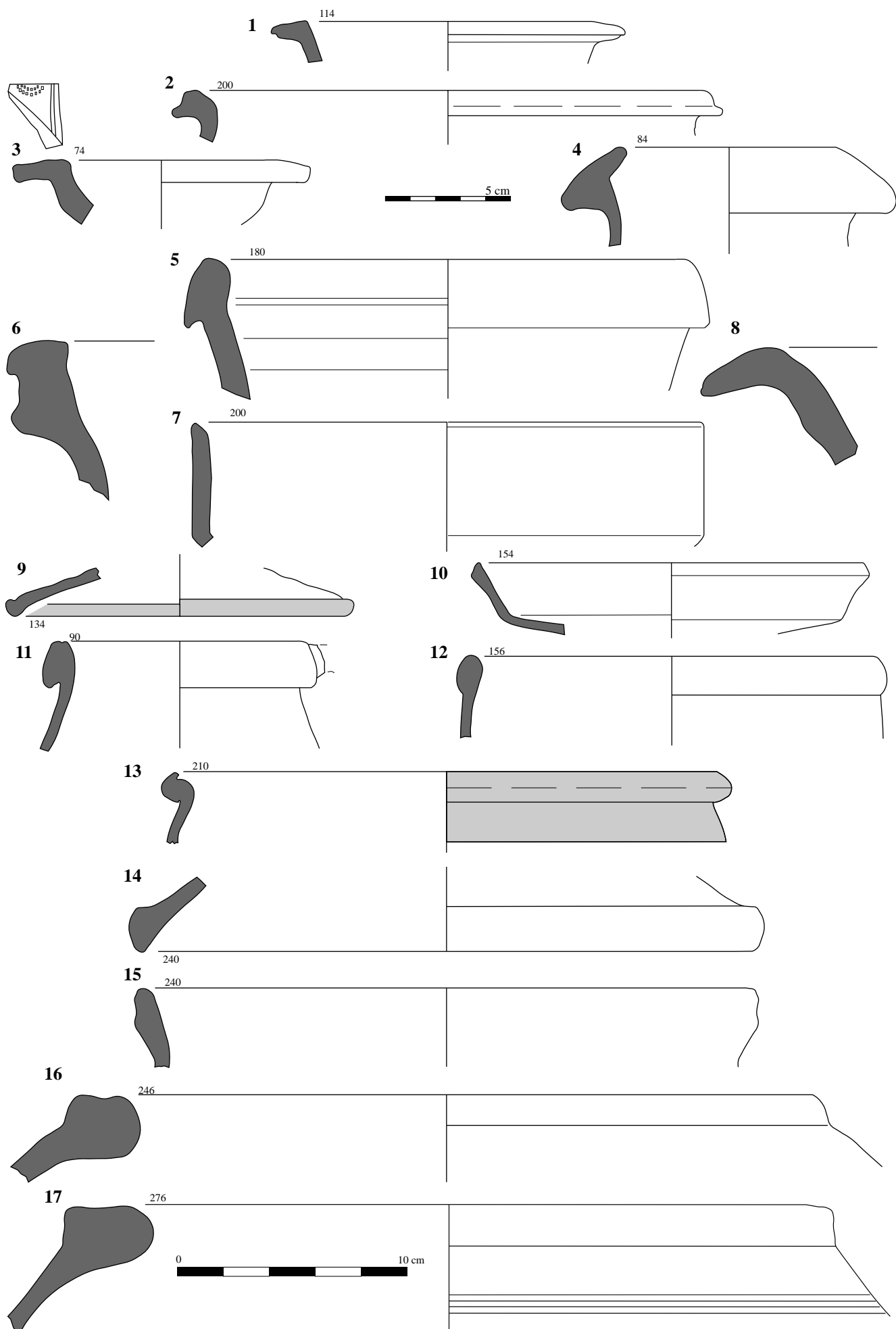

Làm. 32: Ceràmica imperial del Mas de Molló 2 [49] (Móra la Nova).

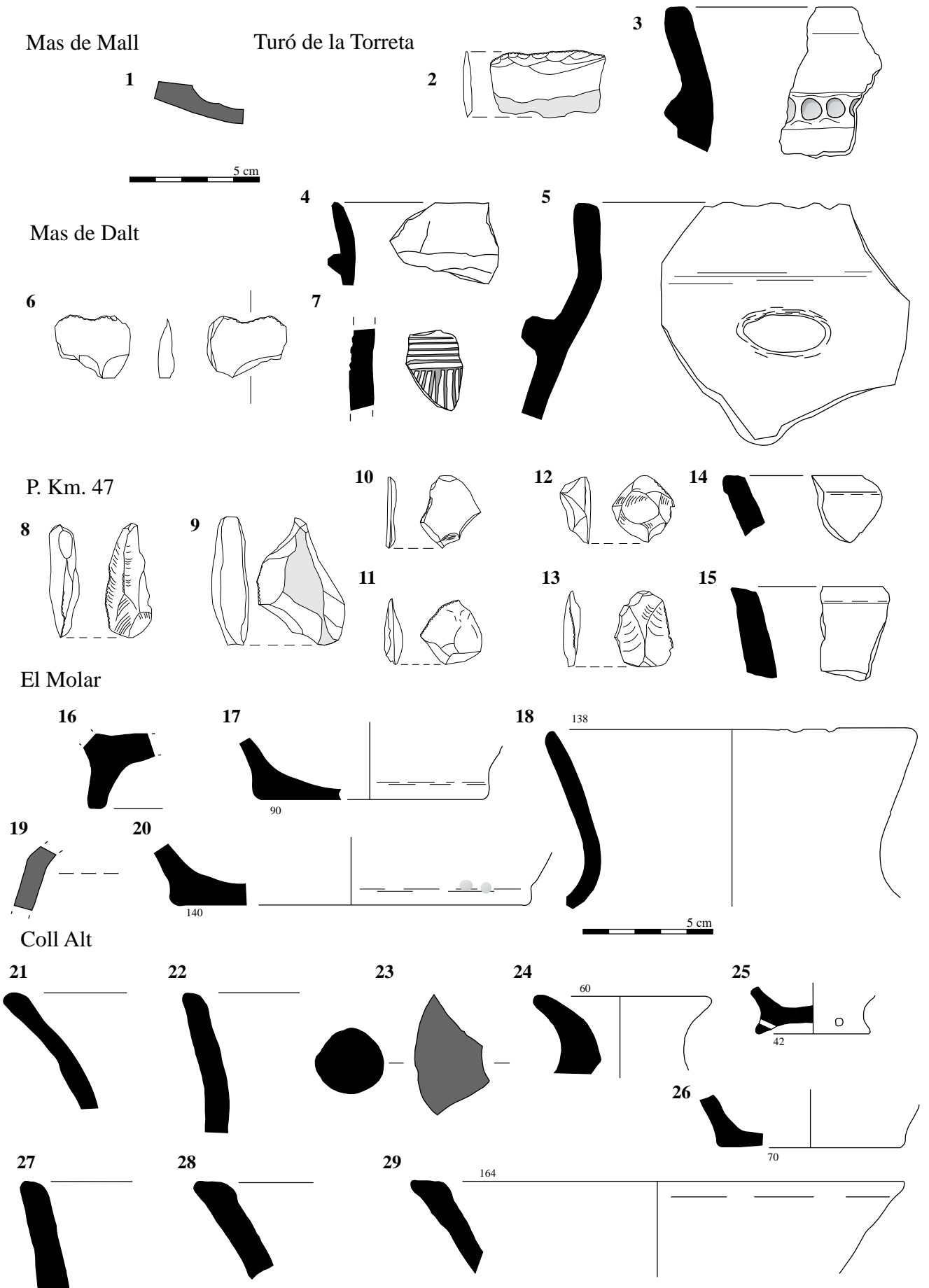

Làm. 33: Fragments d'àmfores fenícies, ceràmica a mà i sílex del Mas de Mall [50] (Tivissa), Turó de la Torreta [79] (Miravet), Mas de Dalt [61] (Tivissa), Punt km 47 [62] (Ginestar), el Calvari [33] (el Molar) i el Coll Alt [56] (Tivissa).

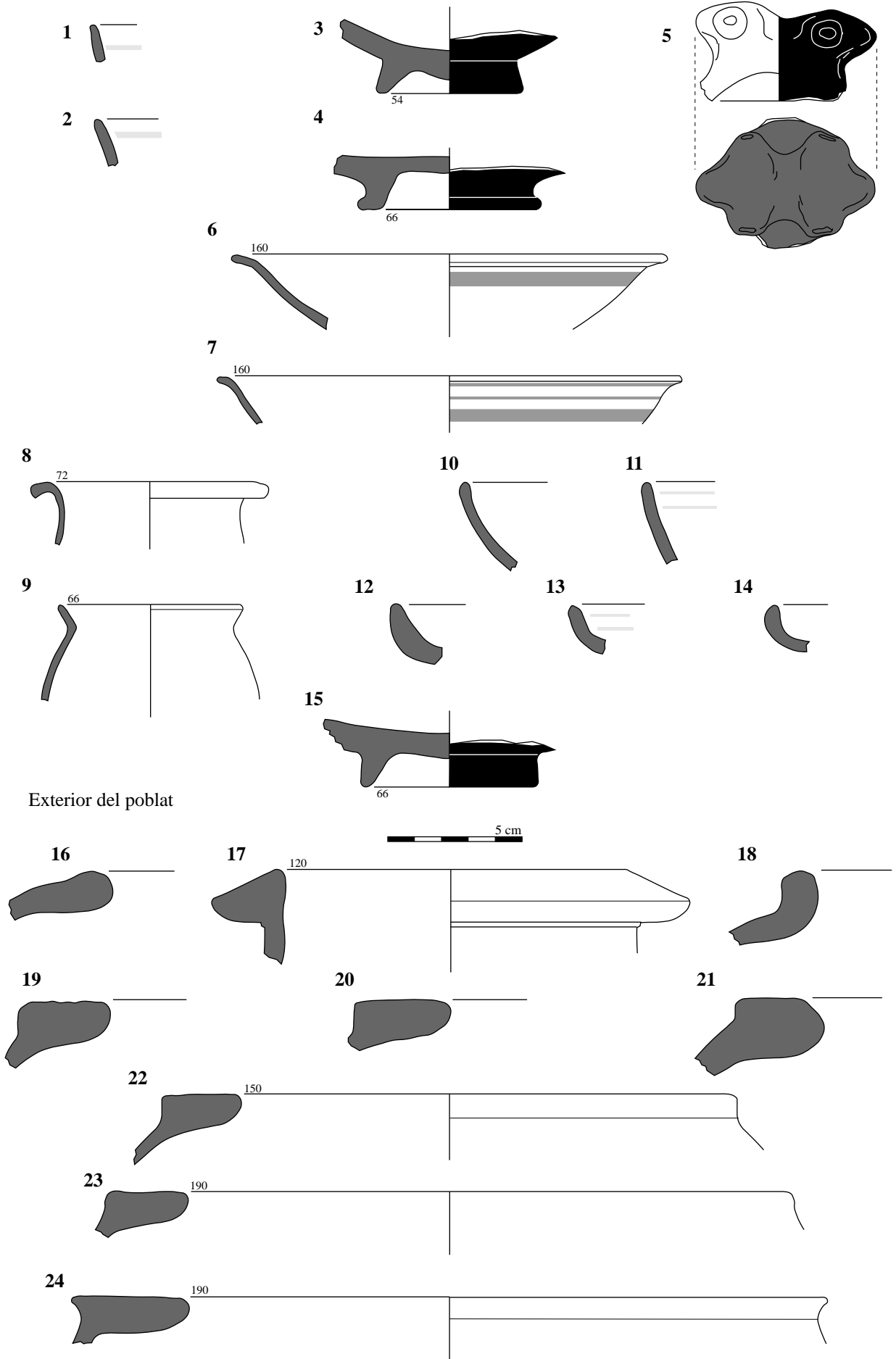

Làm. 34: Materials del Castellet de Banyoles [51] (Tivissa), dipositats en el Museu Comarcal del Montsià, i ceràmiques recuperades a l'exterior del poblat.

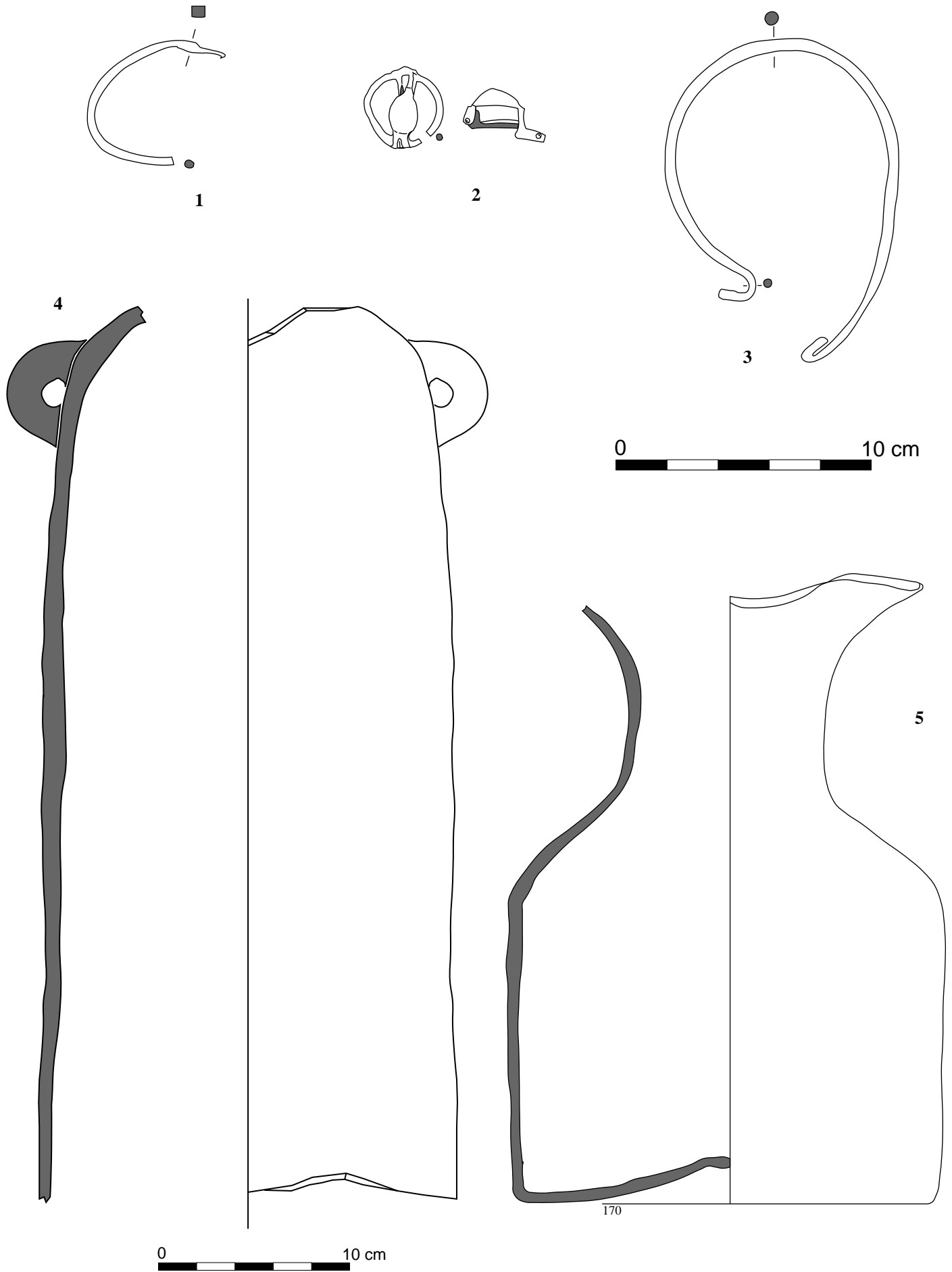

Làm. 35: Material de bronze, àmfora i gerra oinochoe ibèrics procedents del Castellet de Banyoles [51], Tivissa (campanya de 1999). Dibuixos D. Asensio i J. Sanmartí.

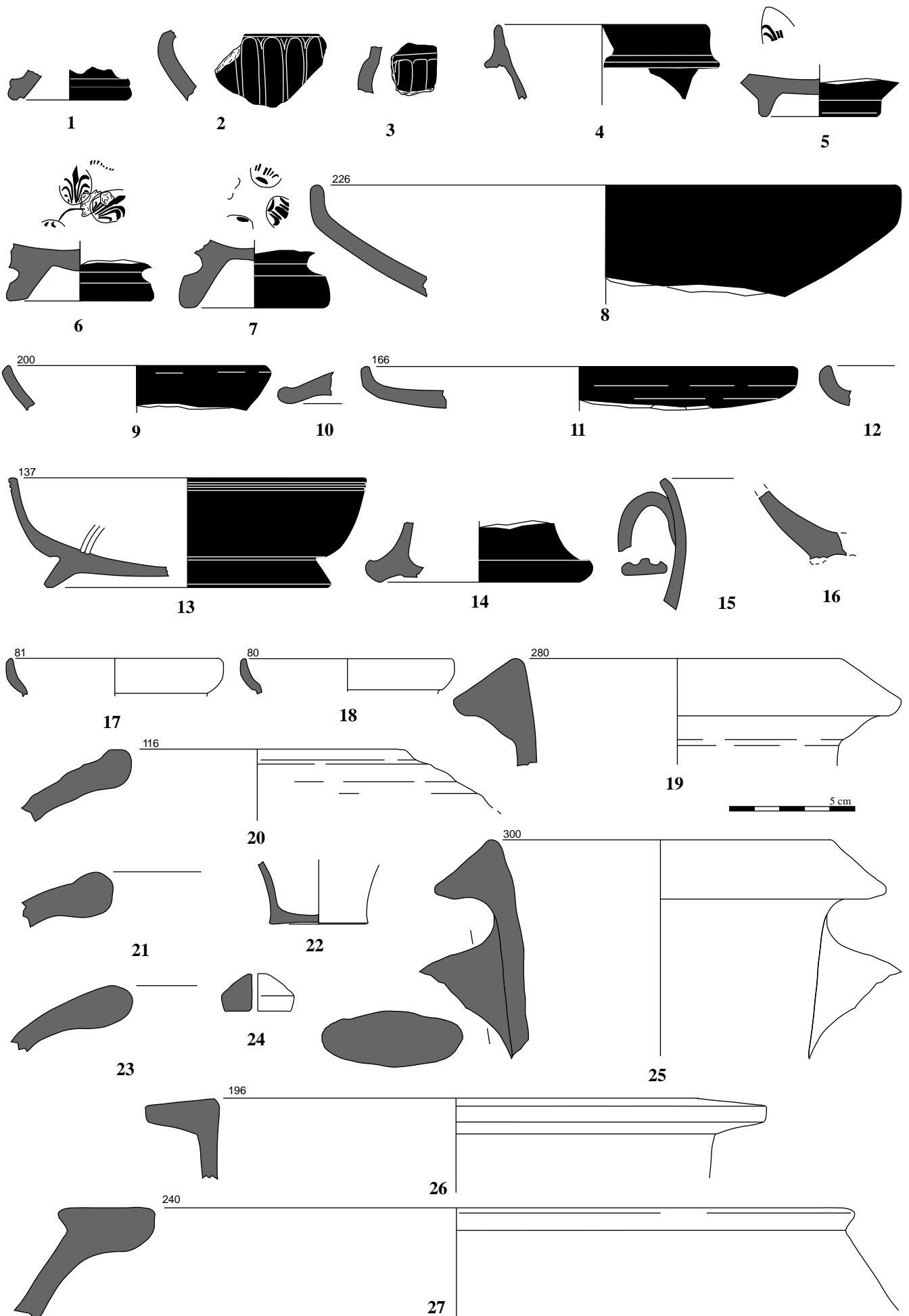

Làm. 36: Material ceràmic del Castellot de Banyoles [51] (Tivissa). Campanya de 1999. Dibuixos D. Asensio i J. Sanmartí.

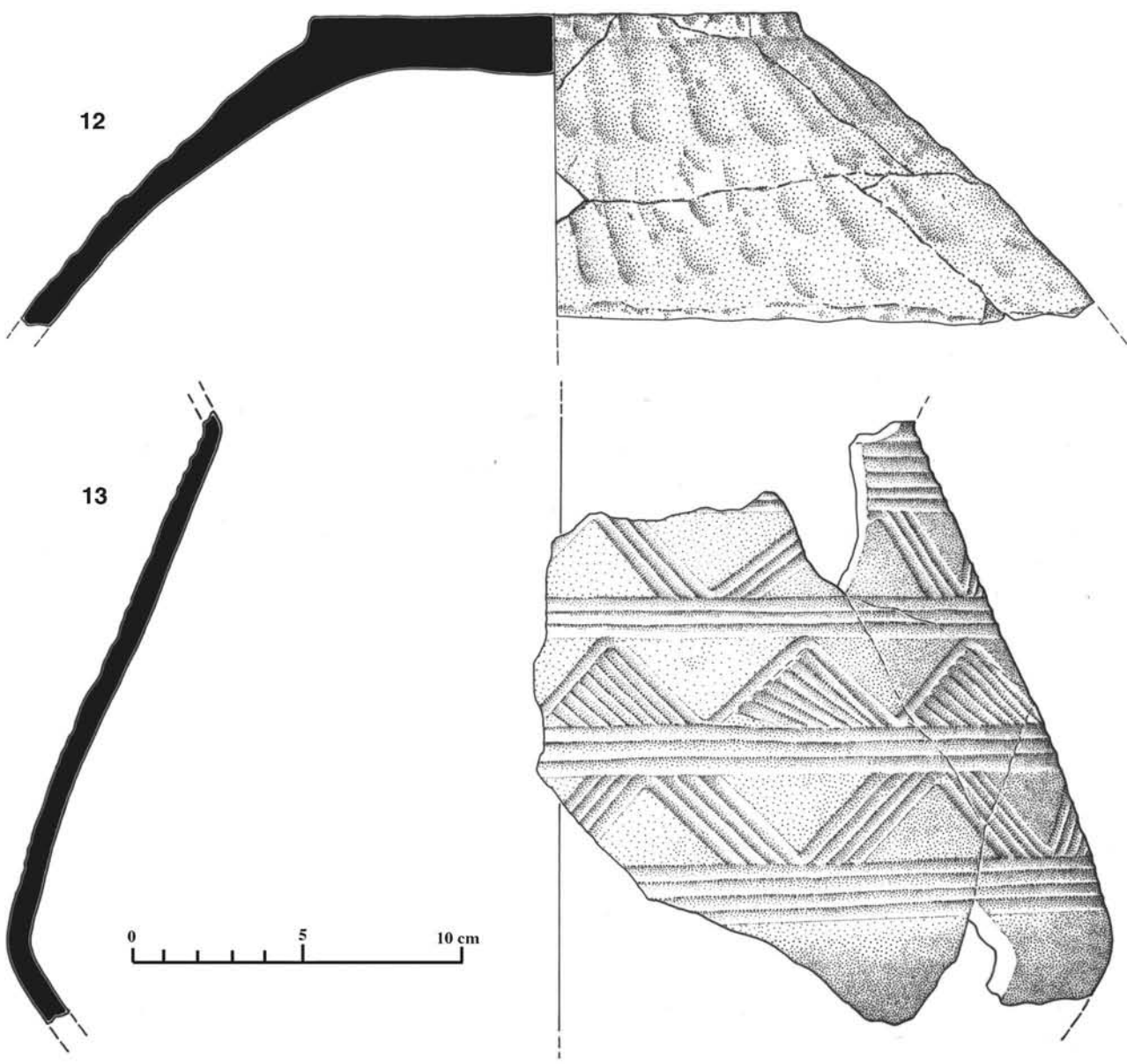
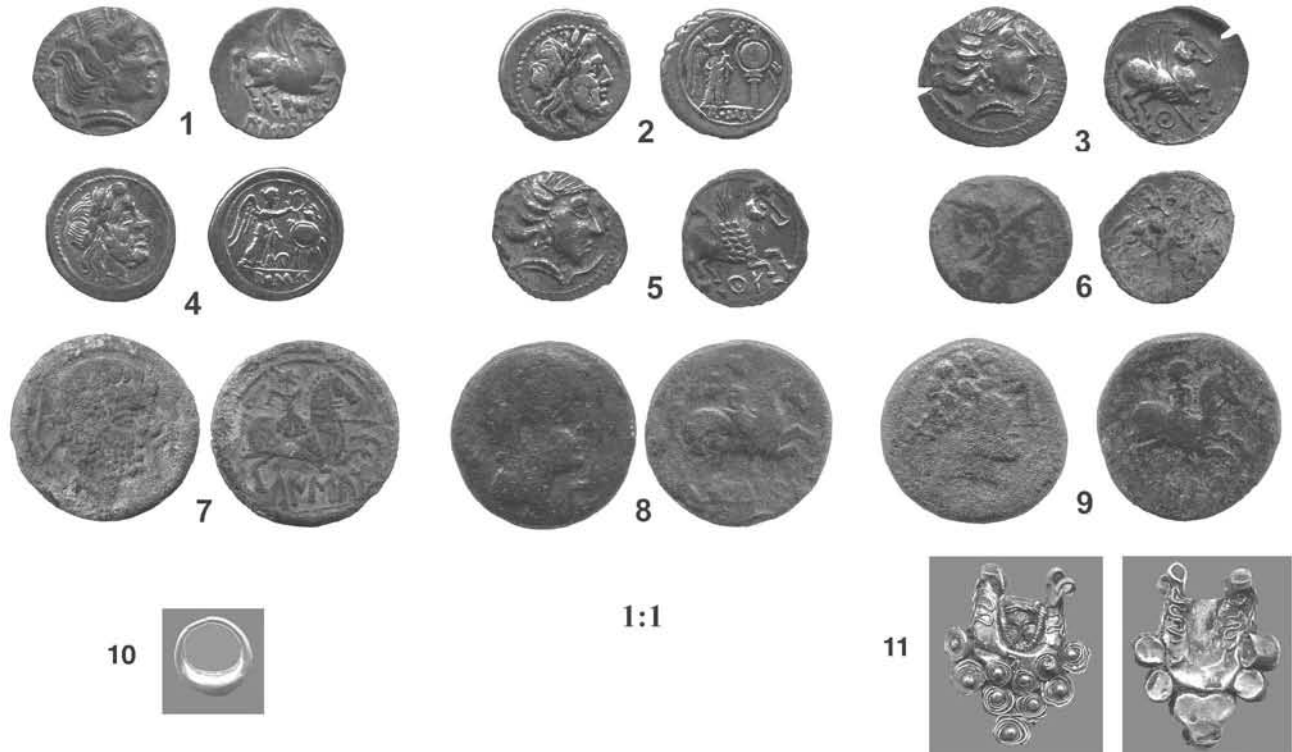

Làm. 37 : Monedes i joies d'or d'època ibèrica, i ceràmica a mà acanalada del bronze final recuperats en el Castellet de Banyoles durant les excavacions de 1998-99.



Làm.38 . Pàteres d'argent del Castellet de Banyoles, Tivissa [51]



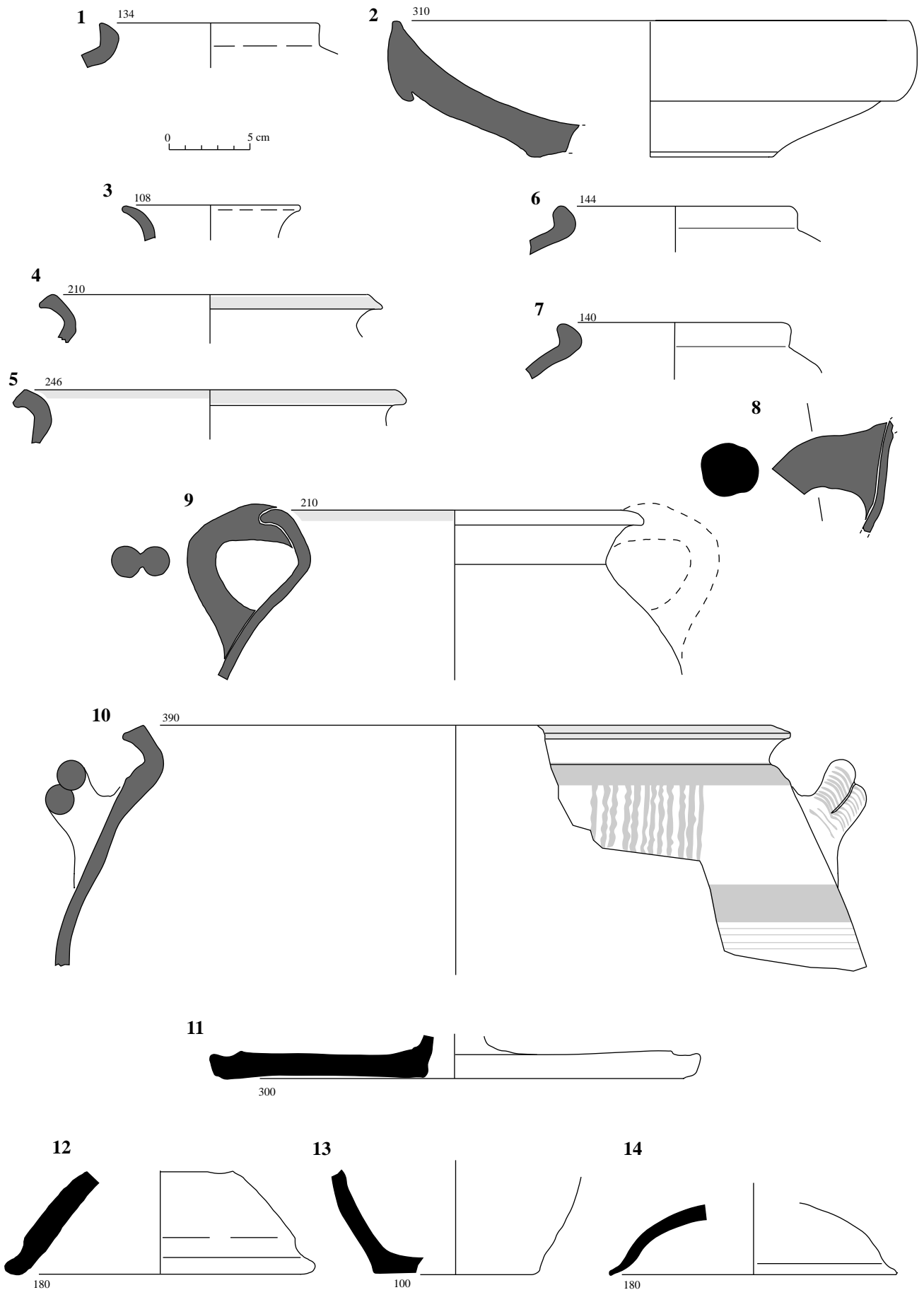

Làm. 39: Materials ceràmics a mà i a torn del Coll del Moro de la Serra d'Almos [55] (Tivissa), procedents de prospeccions.

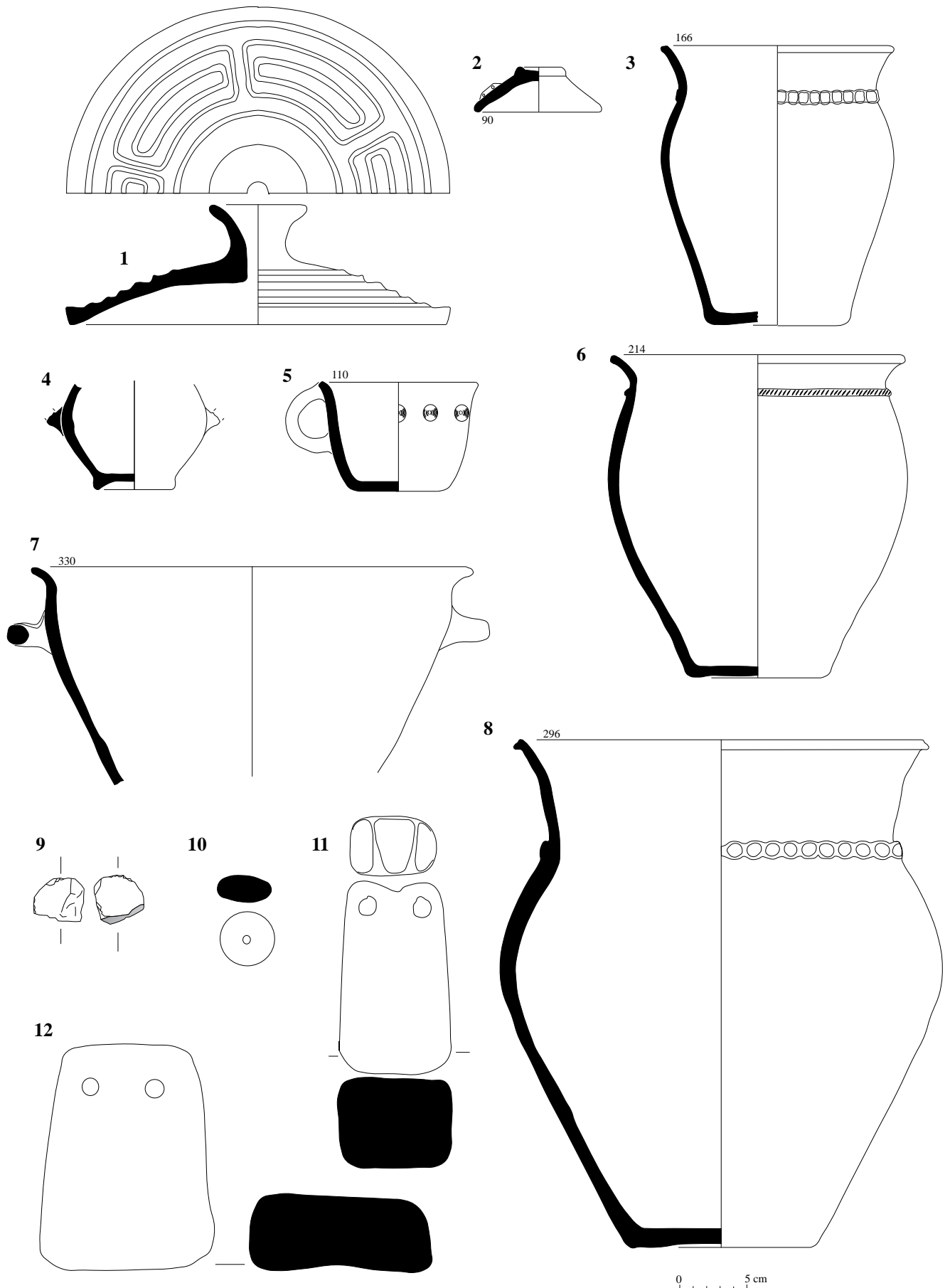

Làm. 40: Material ceràmic a mà, sílex i *pondera* procedent del túmul del Coll del Moro de la Serra d'Almos [55] (Tivissa).

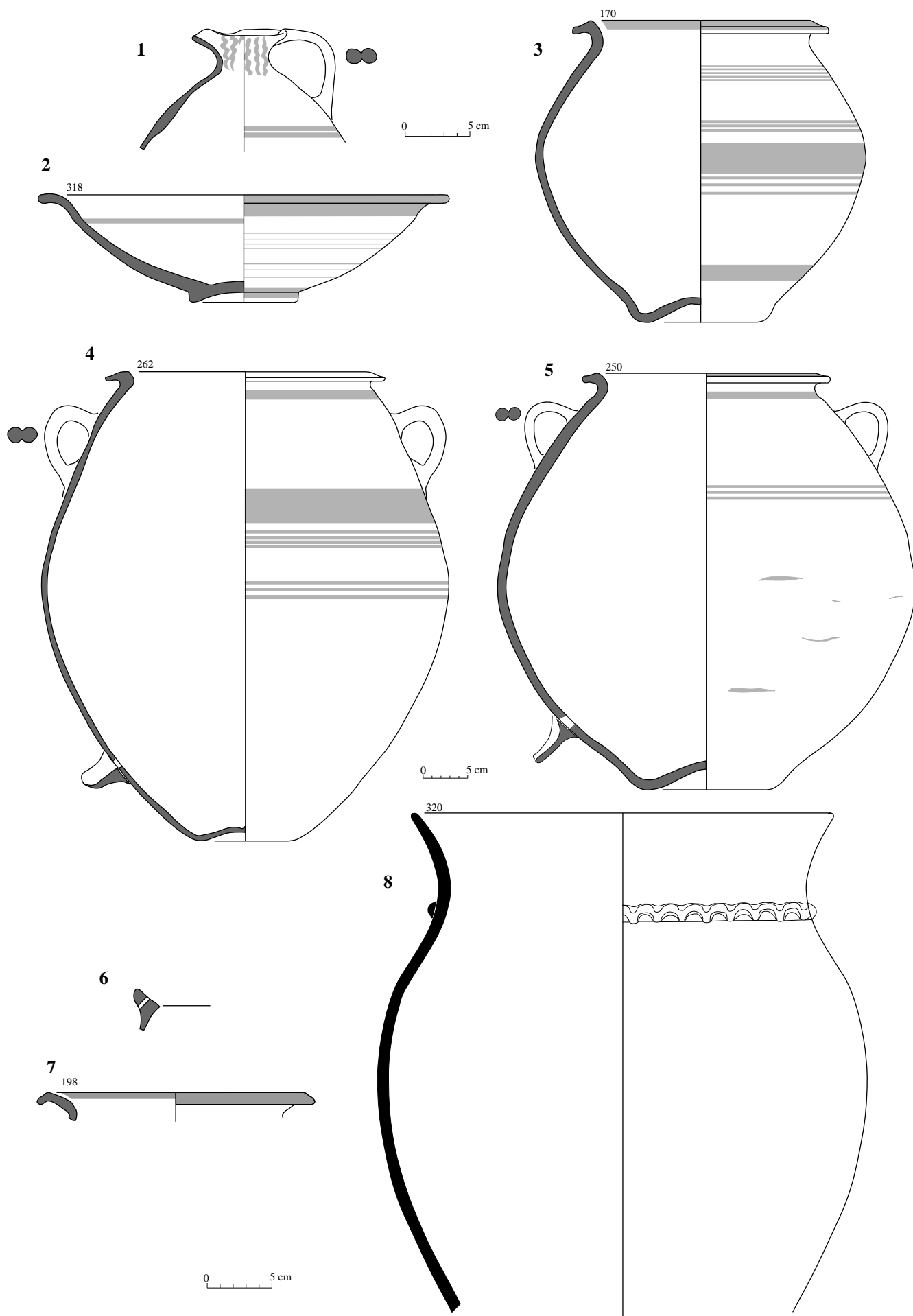

Làm. 41: Ceràmica ibèrica a torn i a mà procedent de la zona del túmul del Coll del Moro de la Serra d'Almos [55] (Tivissa).

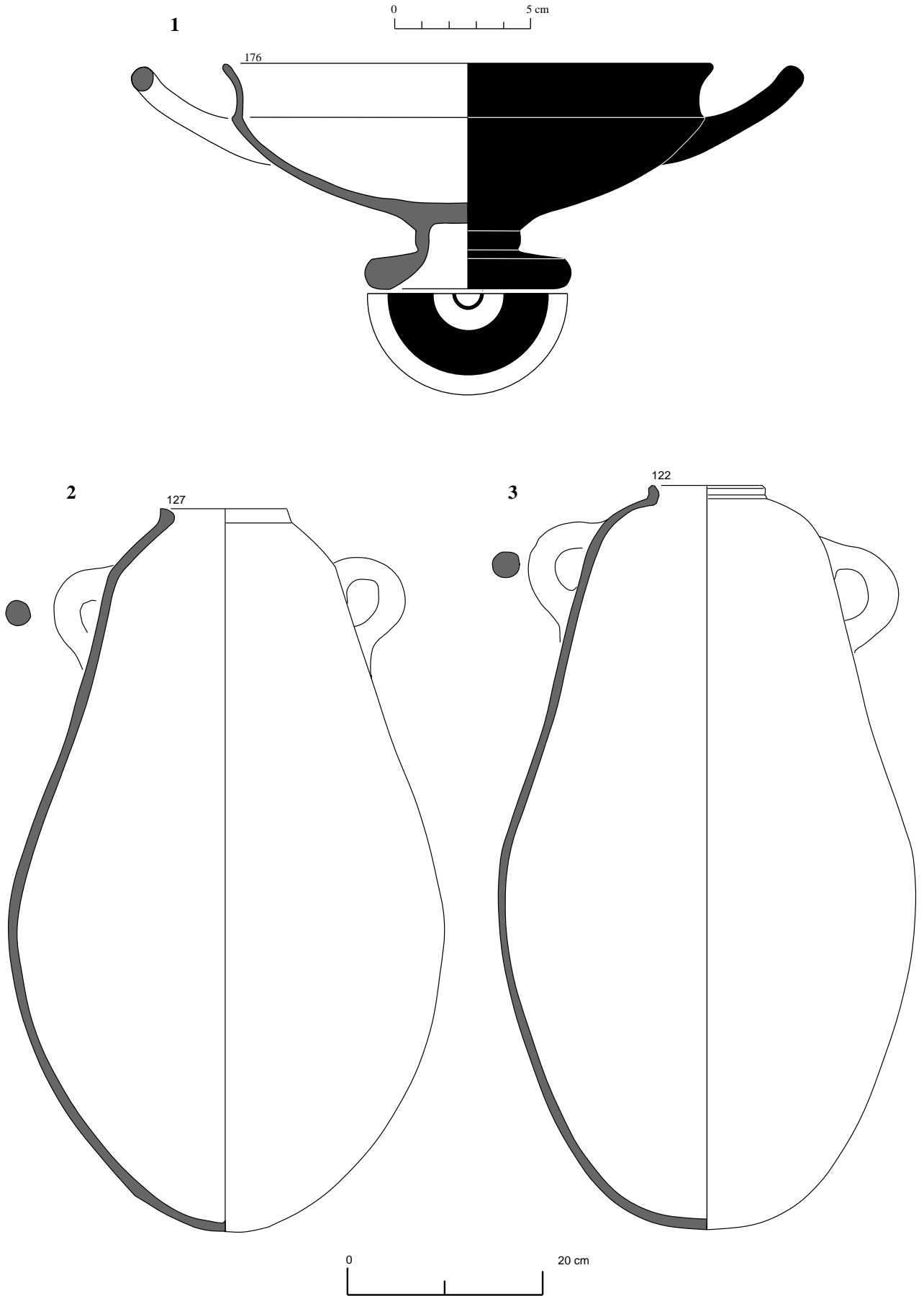

Làm. 42: *Kylix* àtica i àmfores ibèriques procedents de la zona del túmul del Coll del Moro de la Serra d'Almos [55] Tivissa.

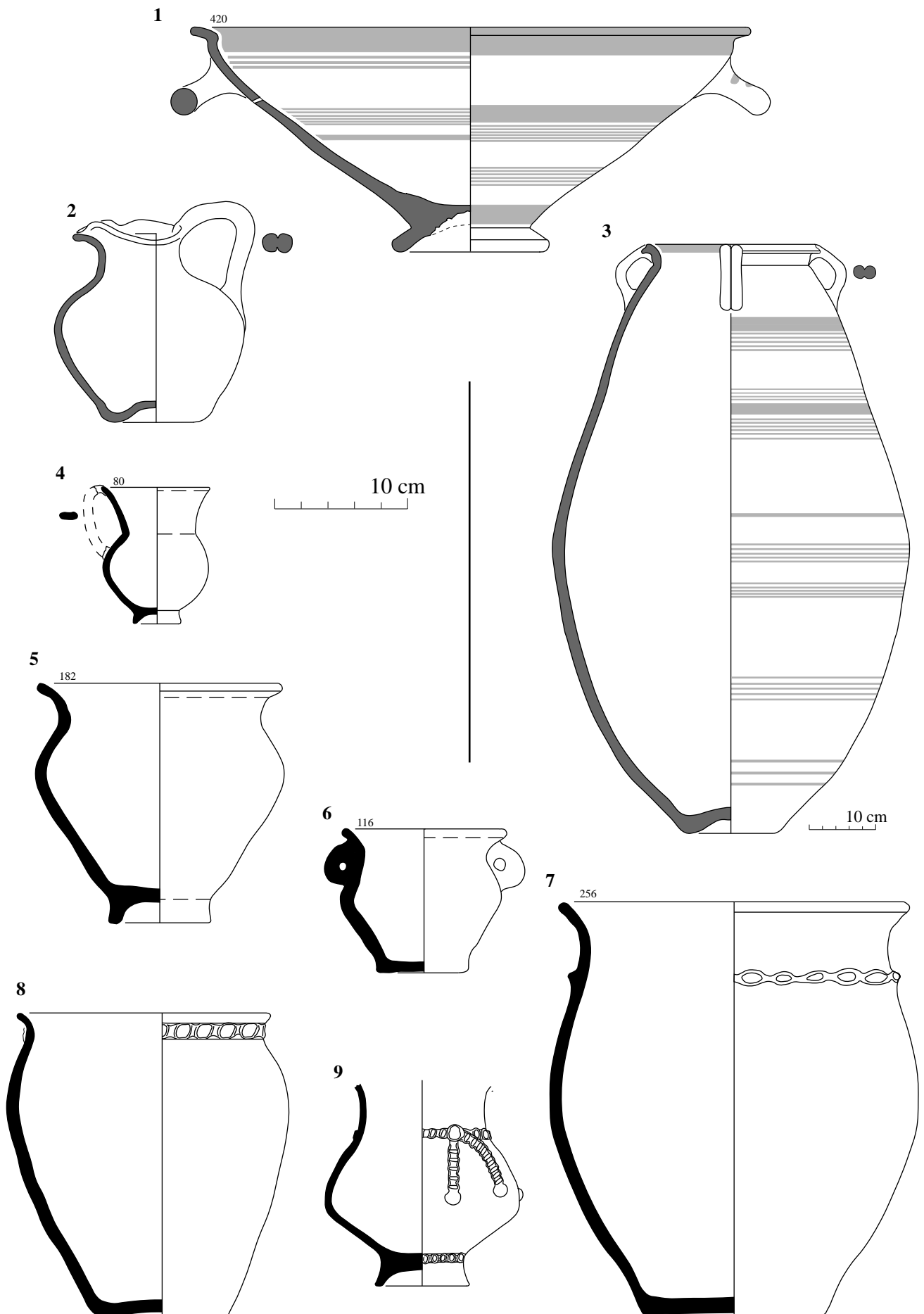

Làm. 43: Material ceràmic procedent de les remocions prèvies a les excavacions de S. Vilaseca en el jaciment del Coll del Moro de la Serra d'Almos [55] (Tivissa).

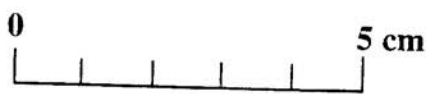
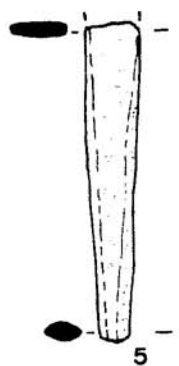
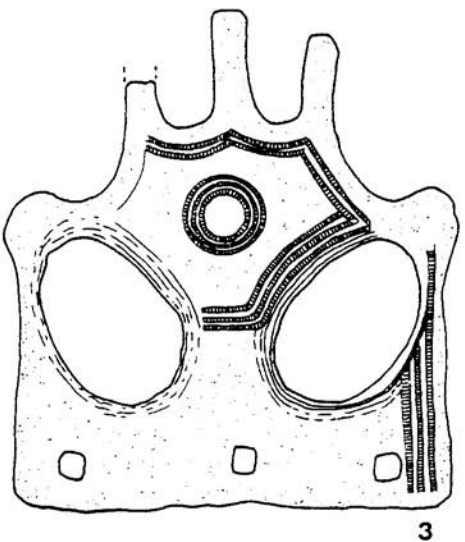
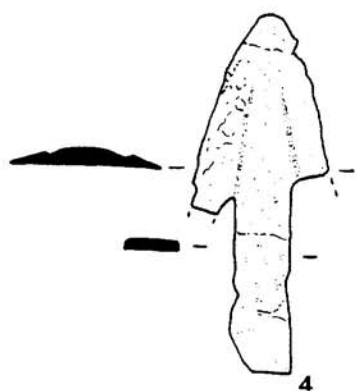
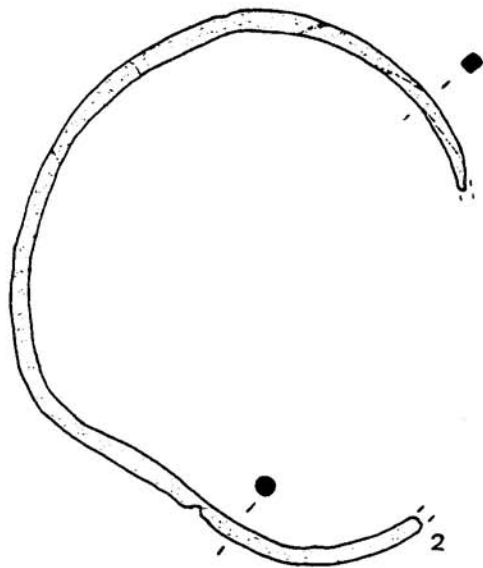
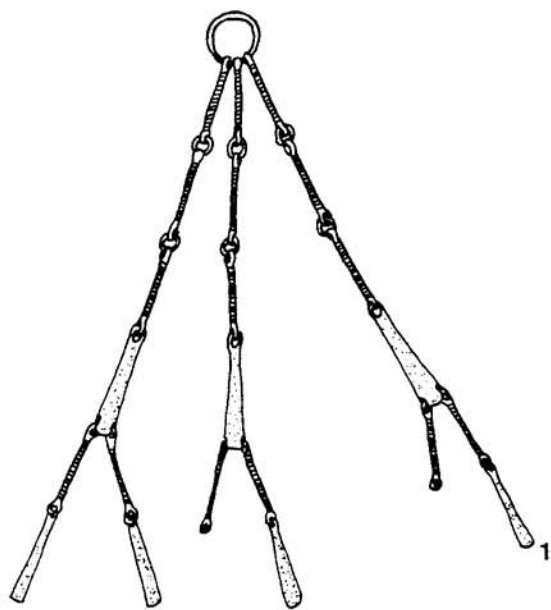

Làm. 44: Objectes de bronze localitzats en el poblat del Coll del Moro de la Serra d'Almos [55] (Tivissa).

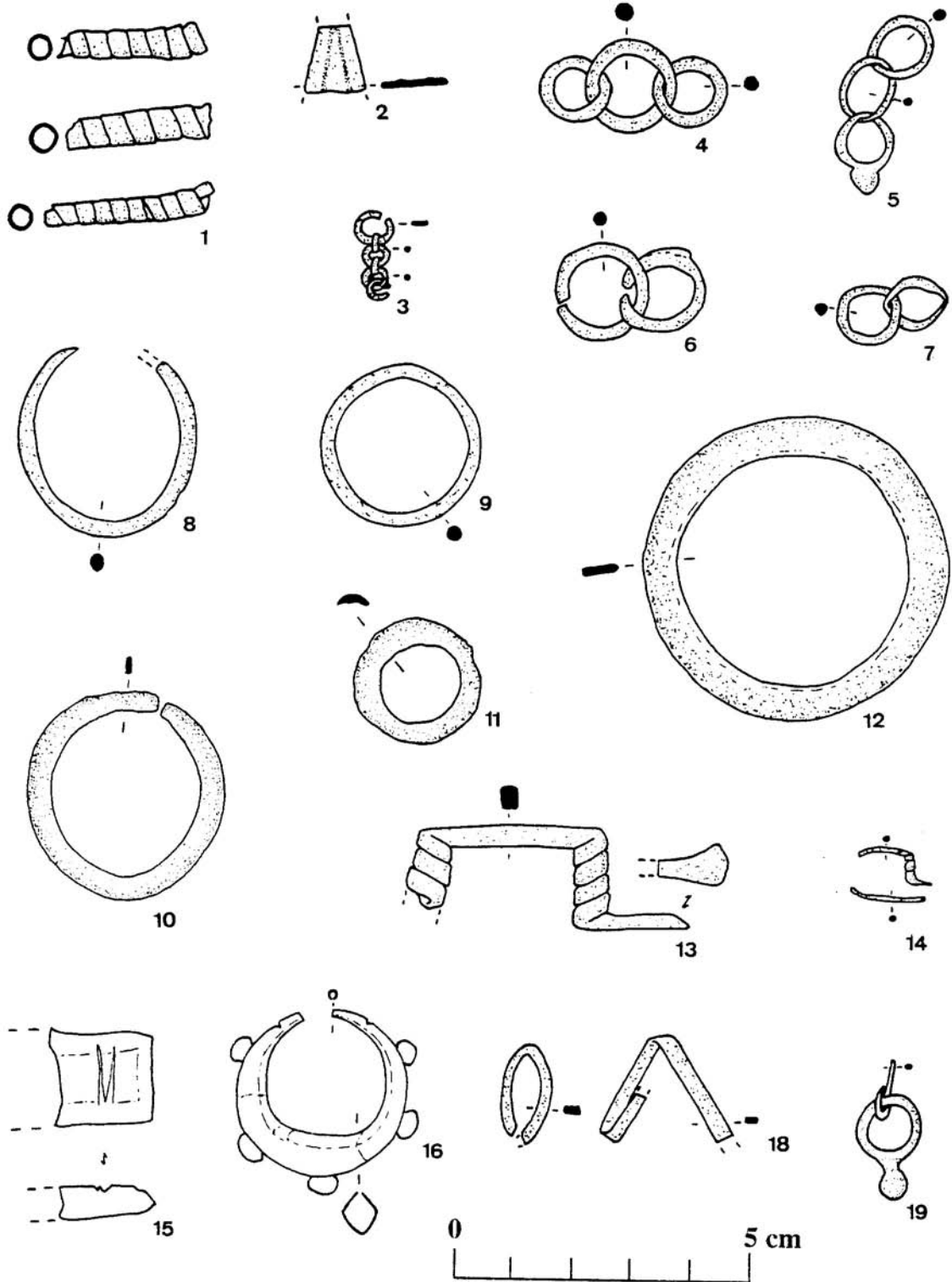

Làm. 45: Objectes de bronze i d'argent localitzats en el poblat i en el túmul del Coll del Moro de la Serra d'Almos [55] (Tivissa).

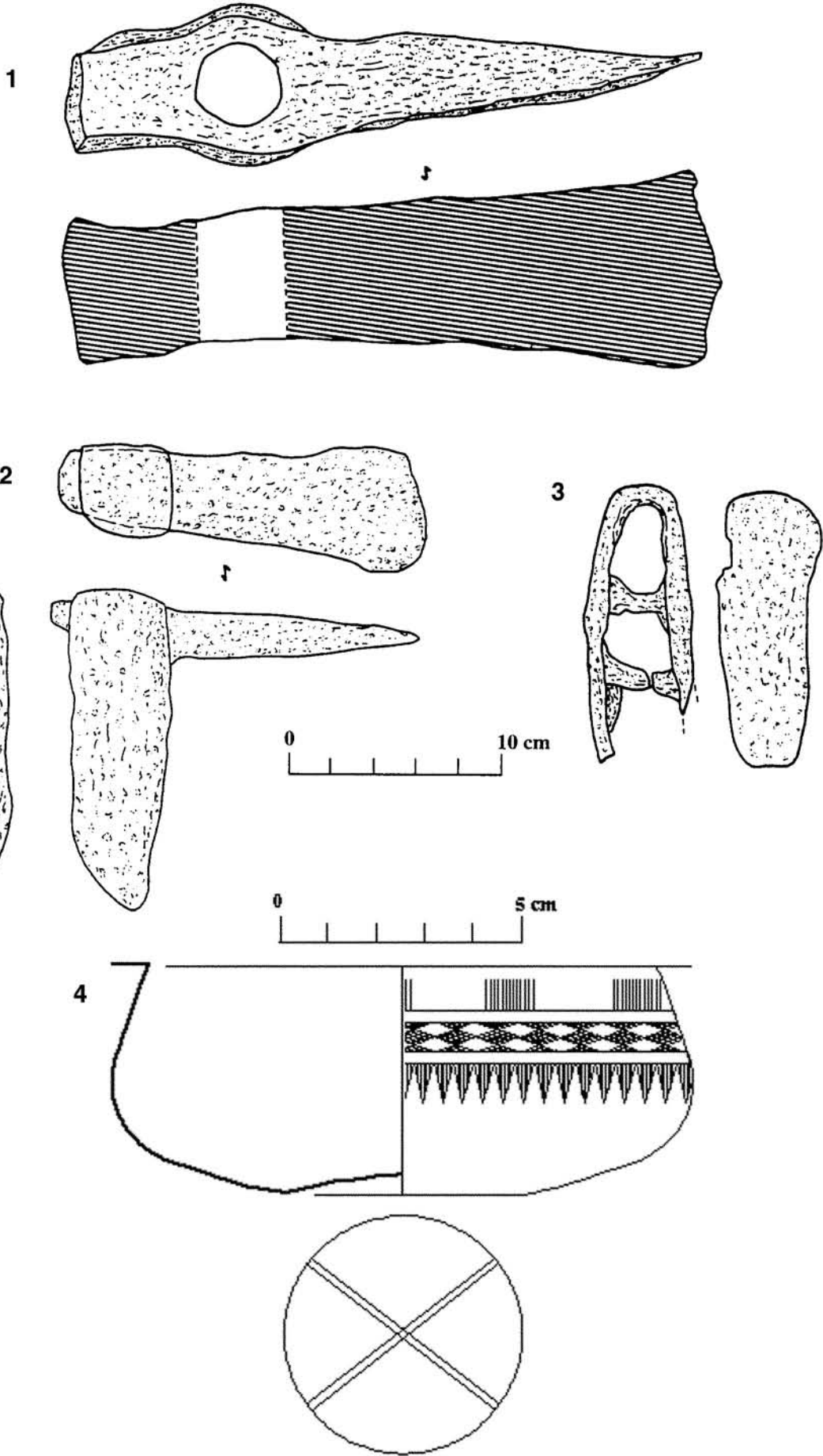

Làm. 46: Estris de ferro i bol de bronze localitzats en el túmul del Coll del Moro de la Serra d'Almos [55] (Tivissa).



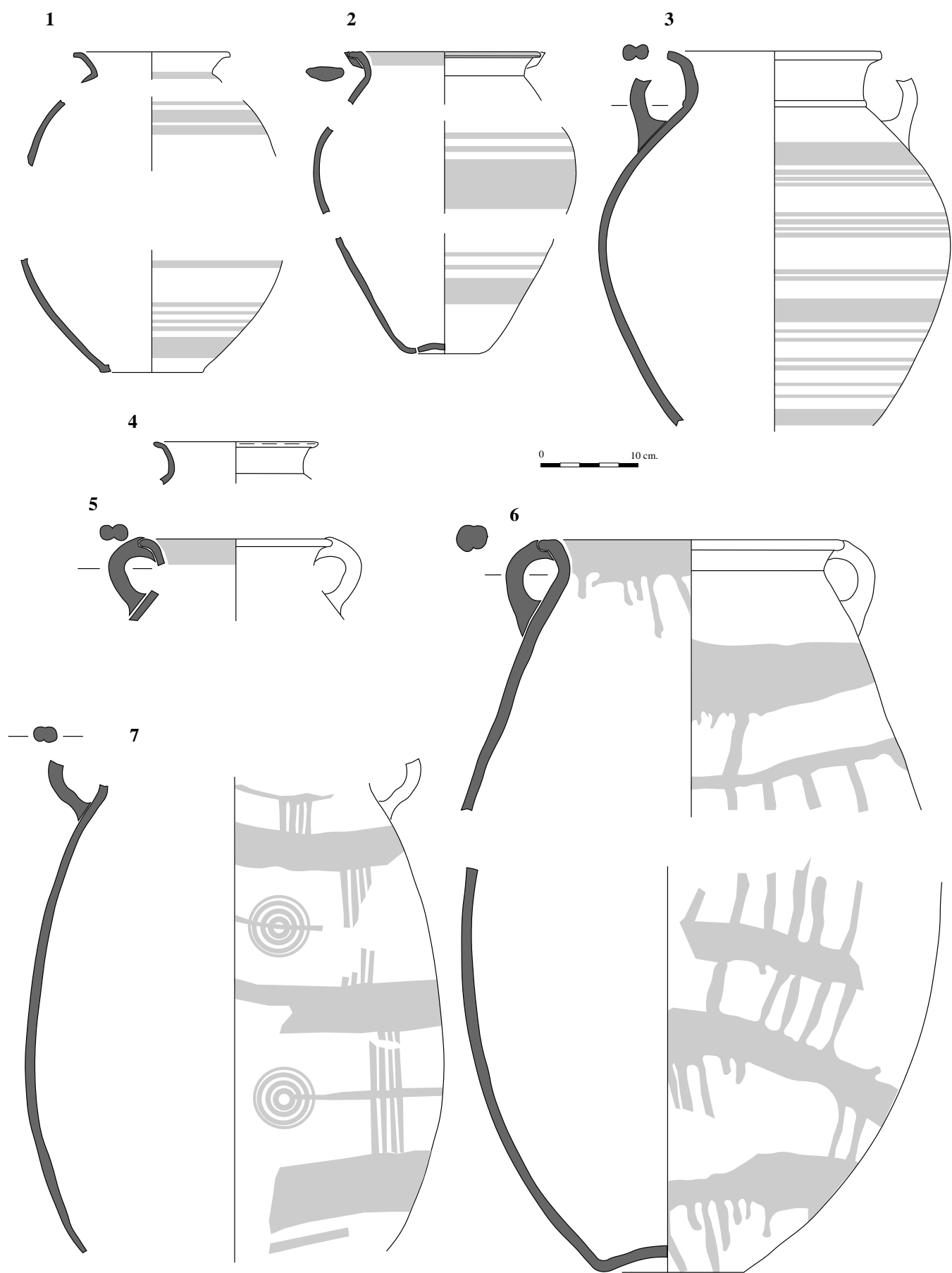

Làm. 47: Ceràmica a torn de la darrera fase del Barranc de Gàfols 1 [65] (Ginestar).

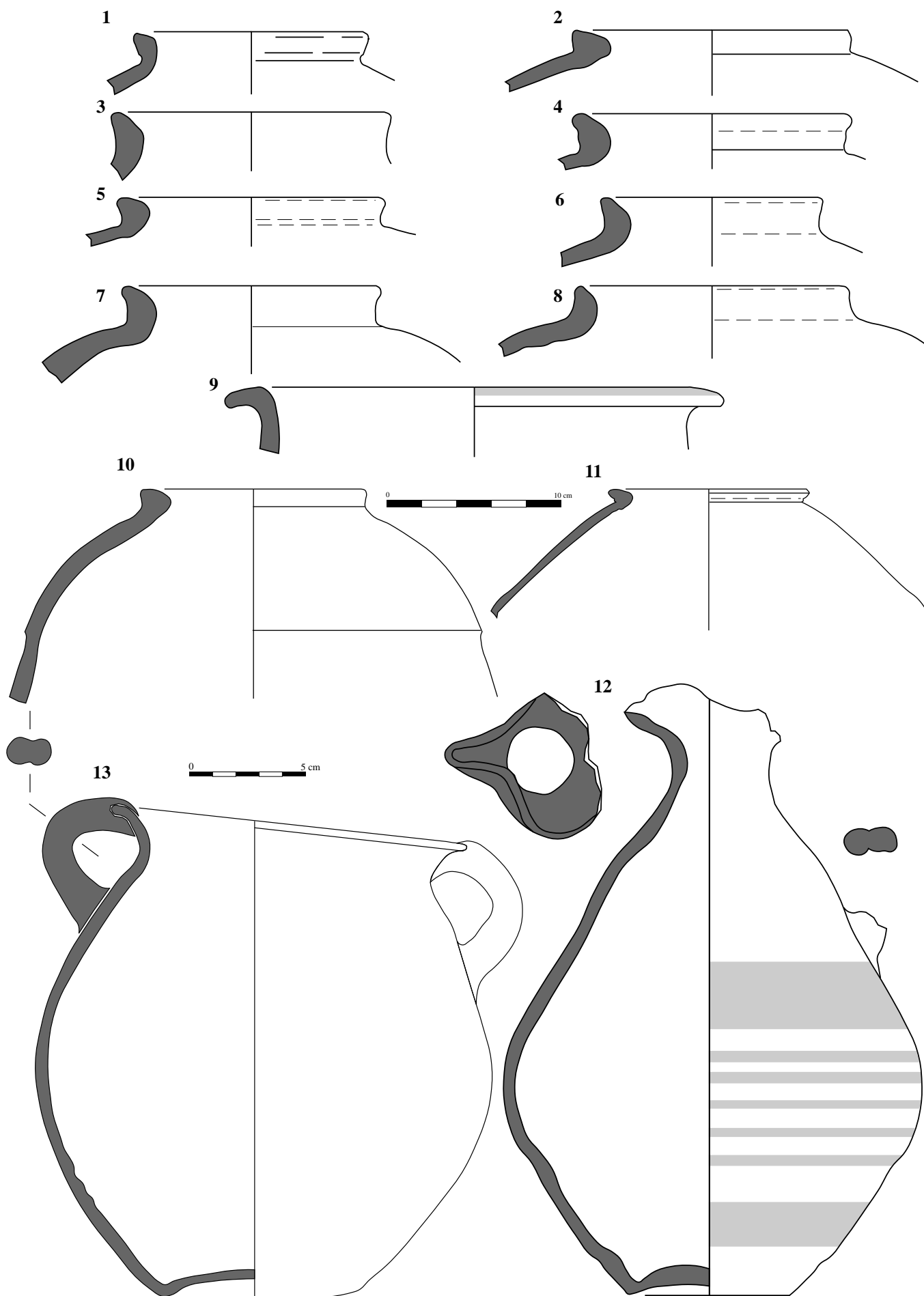

Làm. 48: Vores d'àmfores i *pithos* fenicis, i ceràmica a torn de la darrera fase del Barranc de Gàfols 1 [65] (Ginestar).

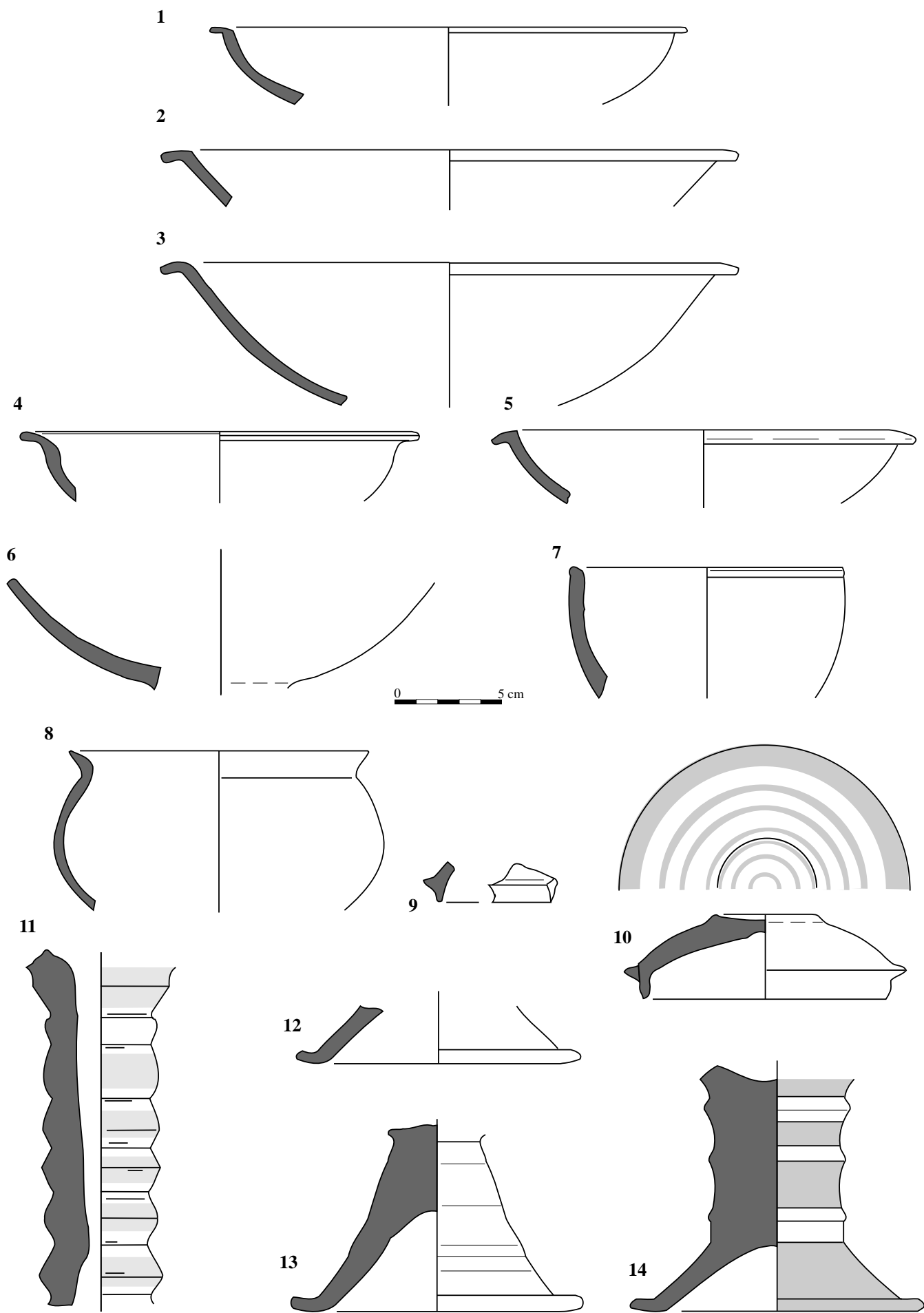

Làm. 49: Ceràmica a torn de la darrera fase del Barranc de Gàfols 1 [65] (Ginestar).

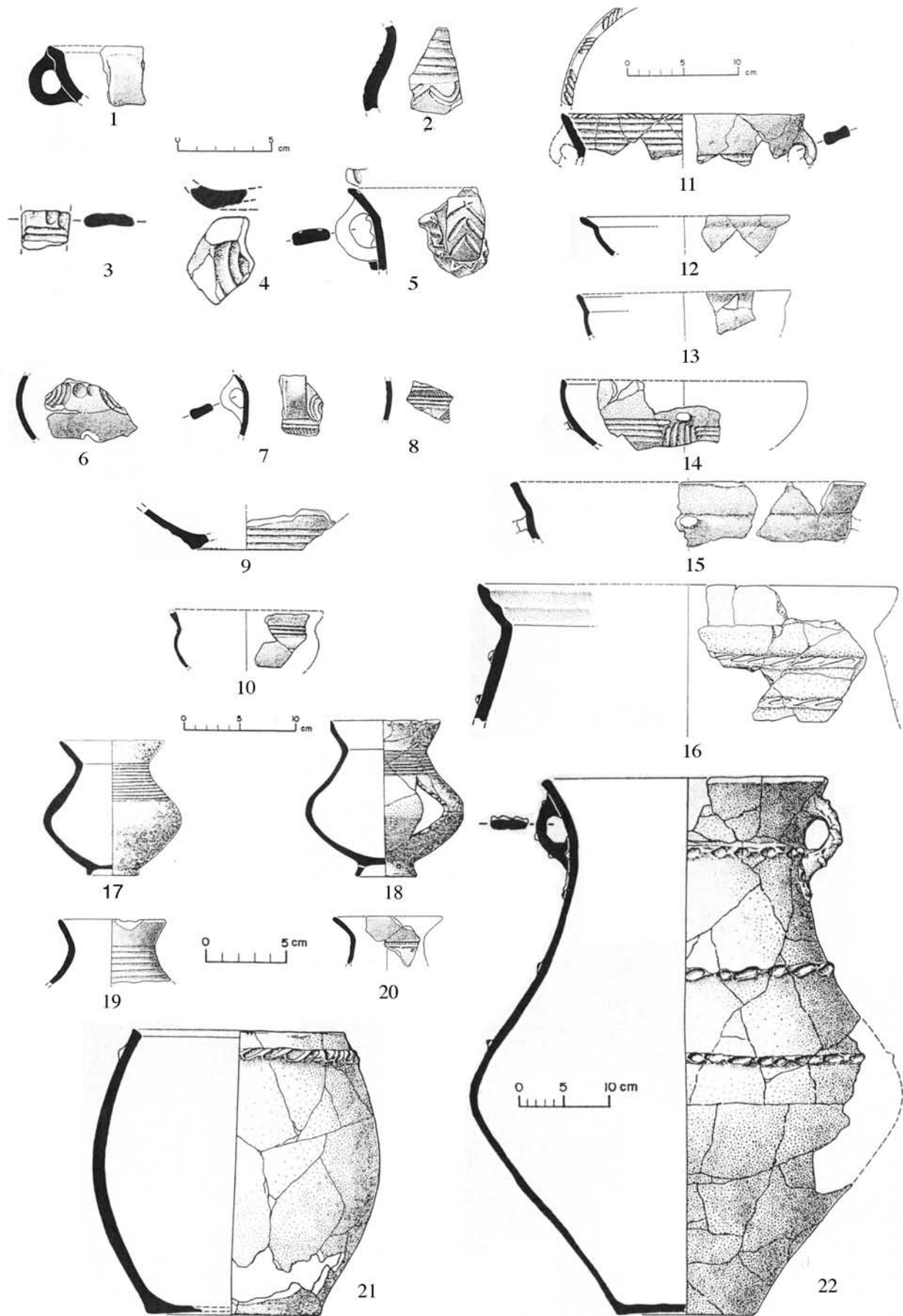

Làm. 50: Materials a mà de la primera fase del Barranc de Sant Antoni 1 [70] (1-16), de la primera fase del Barranc de Gàfols 1 [65] (17-18), i de la darrera fase del Barranc de Sant Antoni 1 (19-22). Dibuixos R. Álvarez.

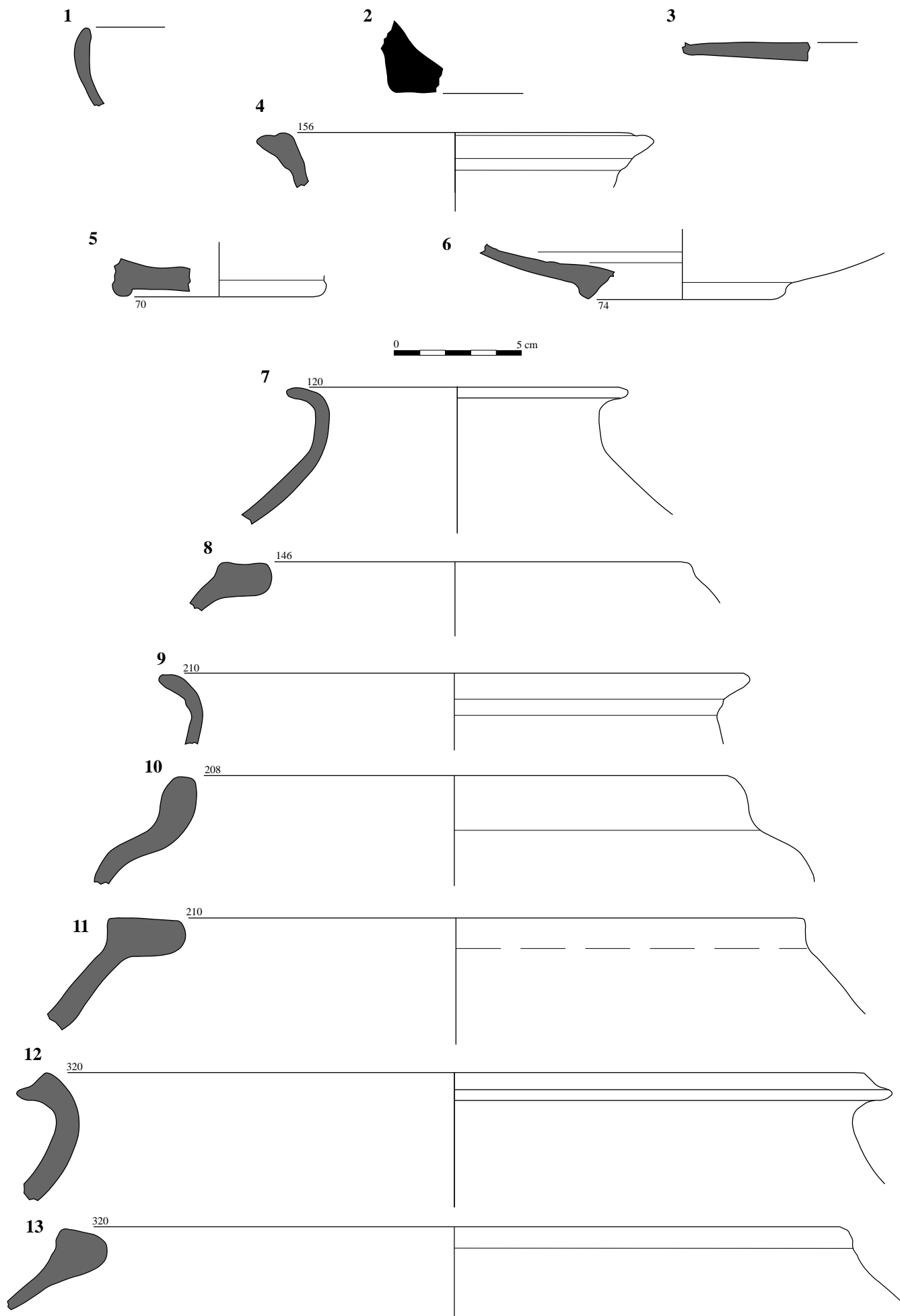

Làm. 51: Materials ceràmics del Castellot de Solà 3 [81] (Miravet).

Castellot de Solà 1

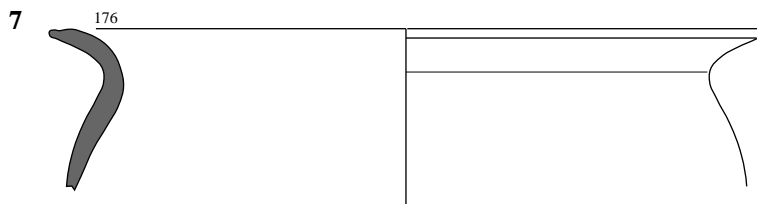
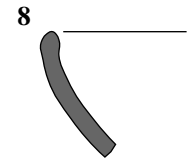
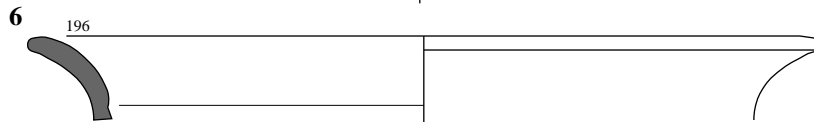
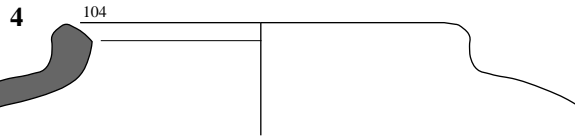
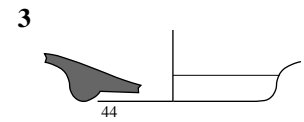
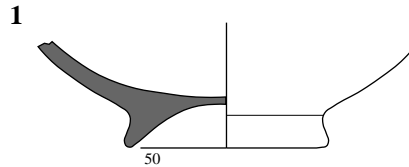
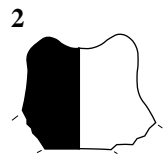

Castellot de Solà 2

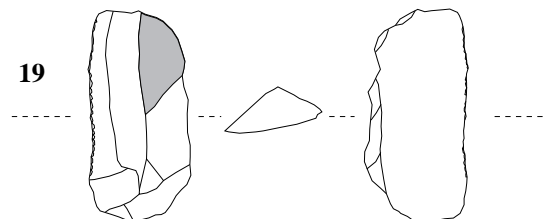
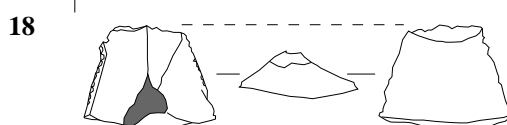
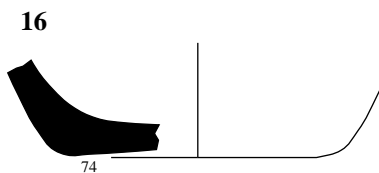
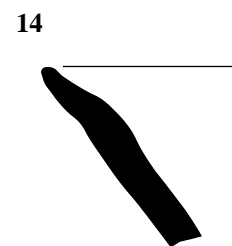
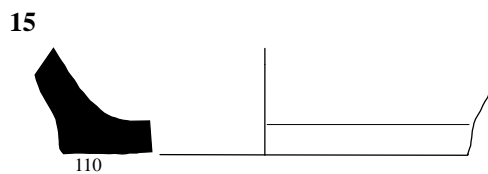
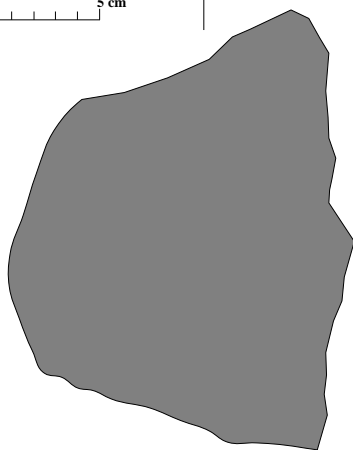
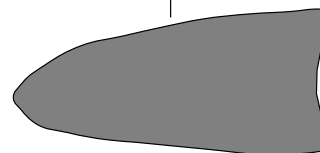
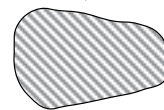
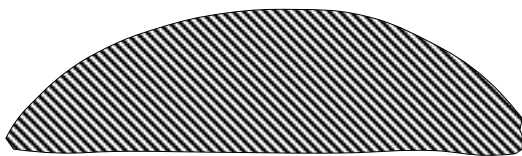
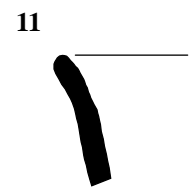
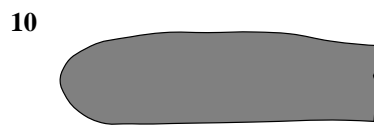
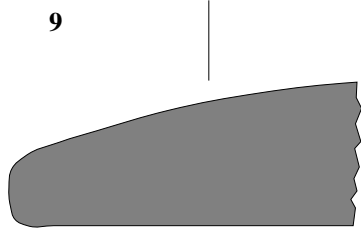

Làm. 52: Ceràmica a mà i a torn, sílex i molins de granit del Castellot de Solà 2 [82] i del Castellot de Solà 1 [83] (Miravet).

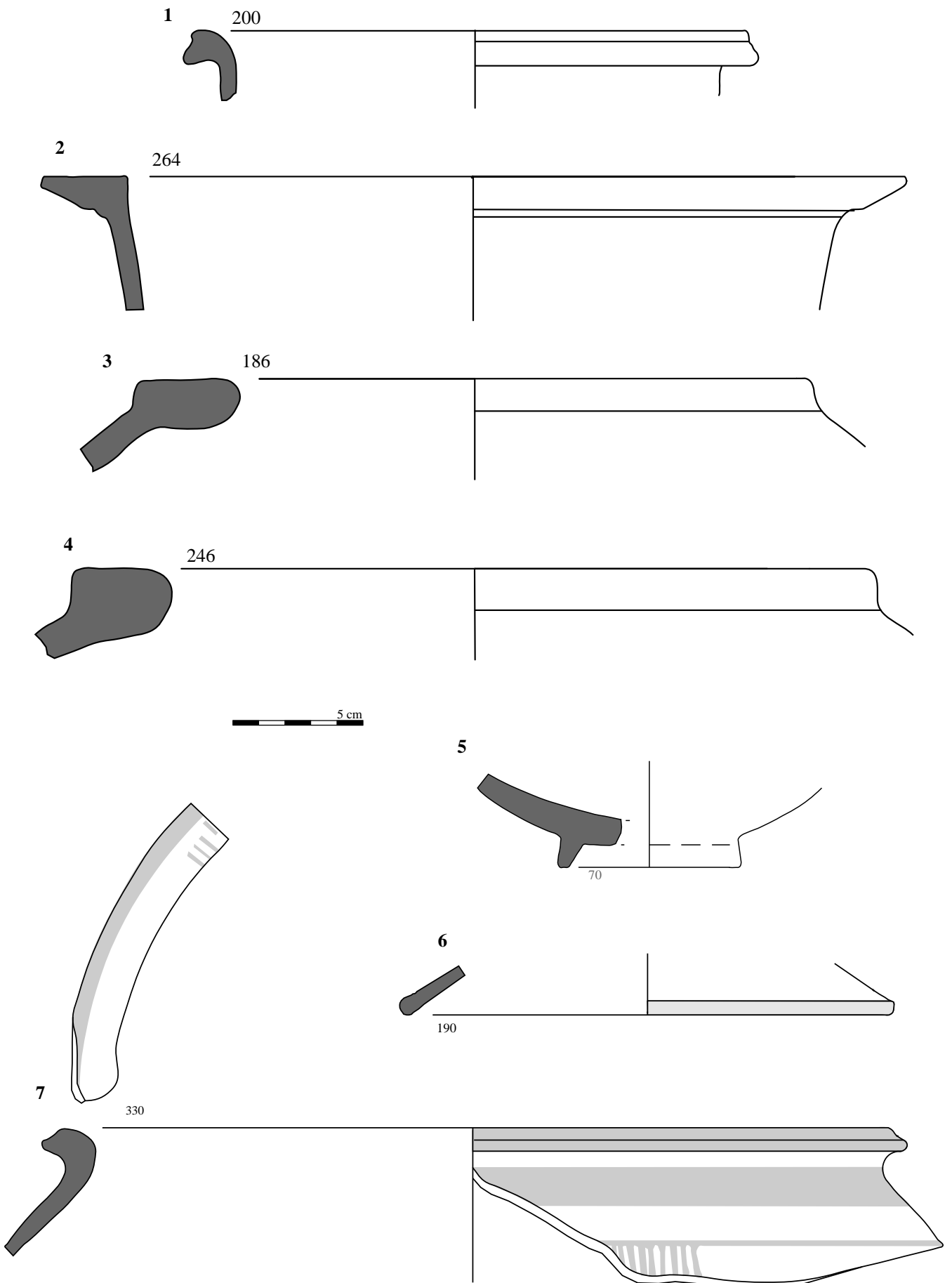

Làm. 53: Ceràmica a torn del jaciment de Viens [84] (Miravet).

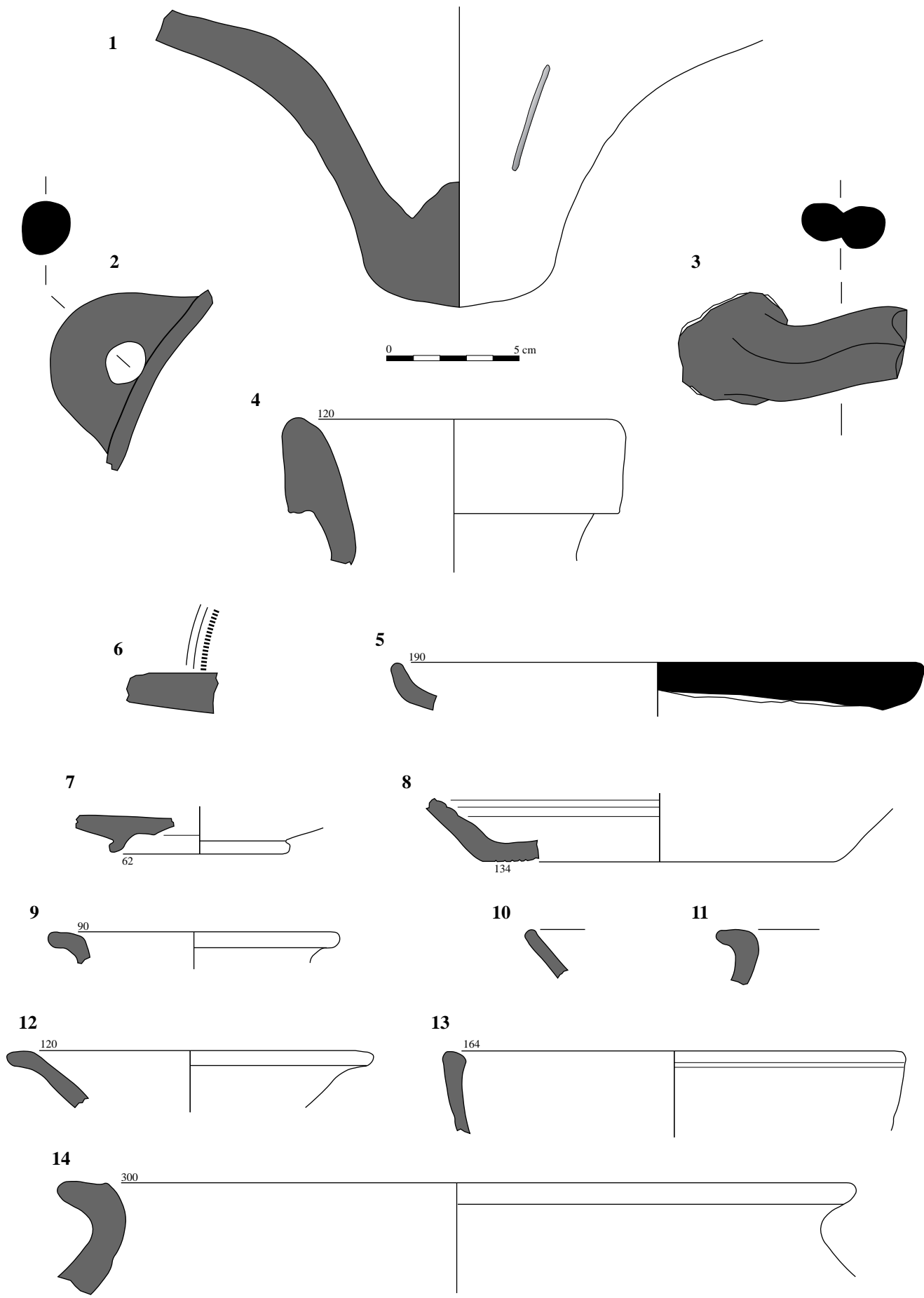

Làm. 54: Ceràmica a torn del jaciment de Viens [84] (Miravet).



Turó de Xalamera

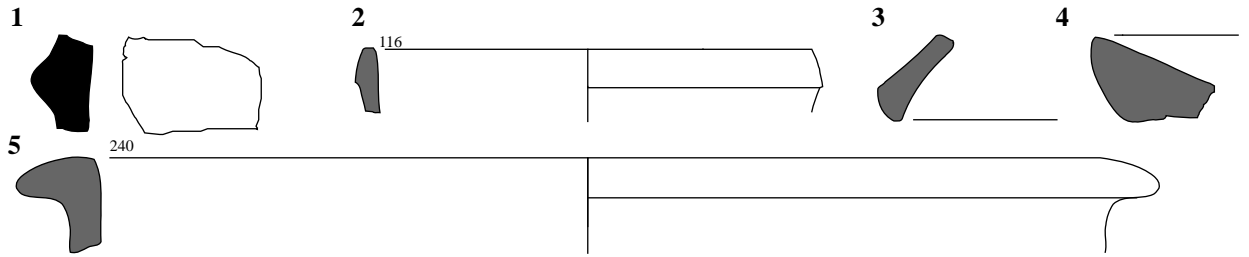

Les Trampes

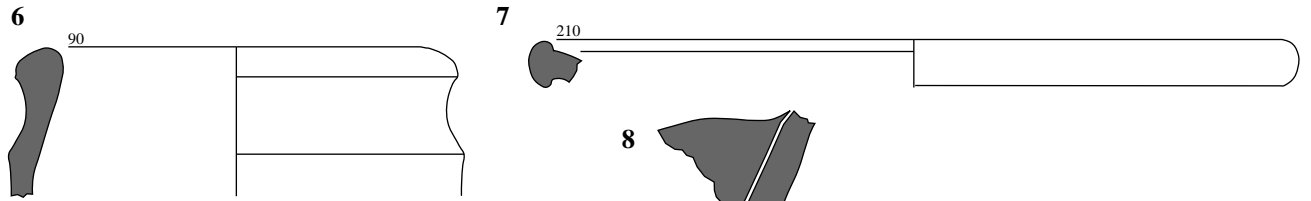

Roca dels Penjats

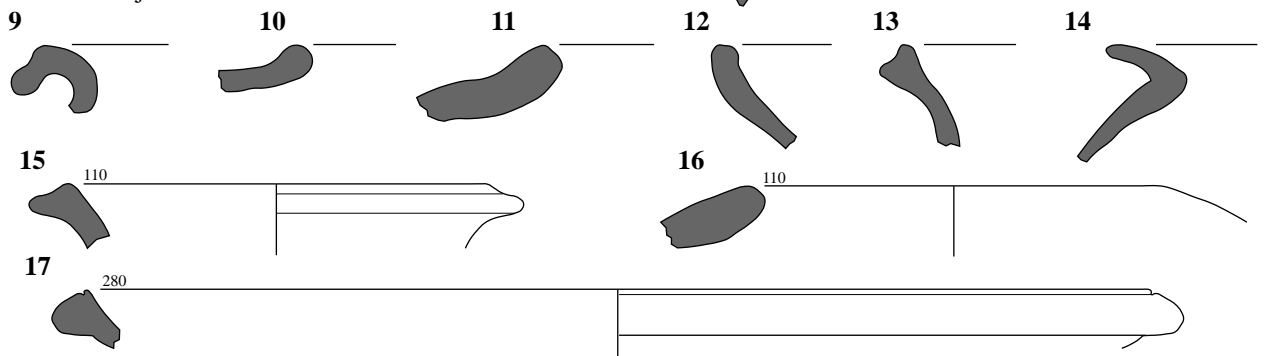

0 5 cm

Lo Toll

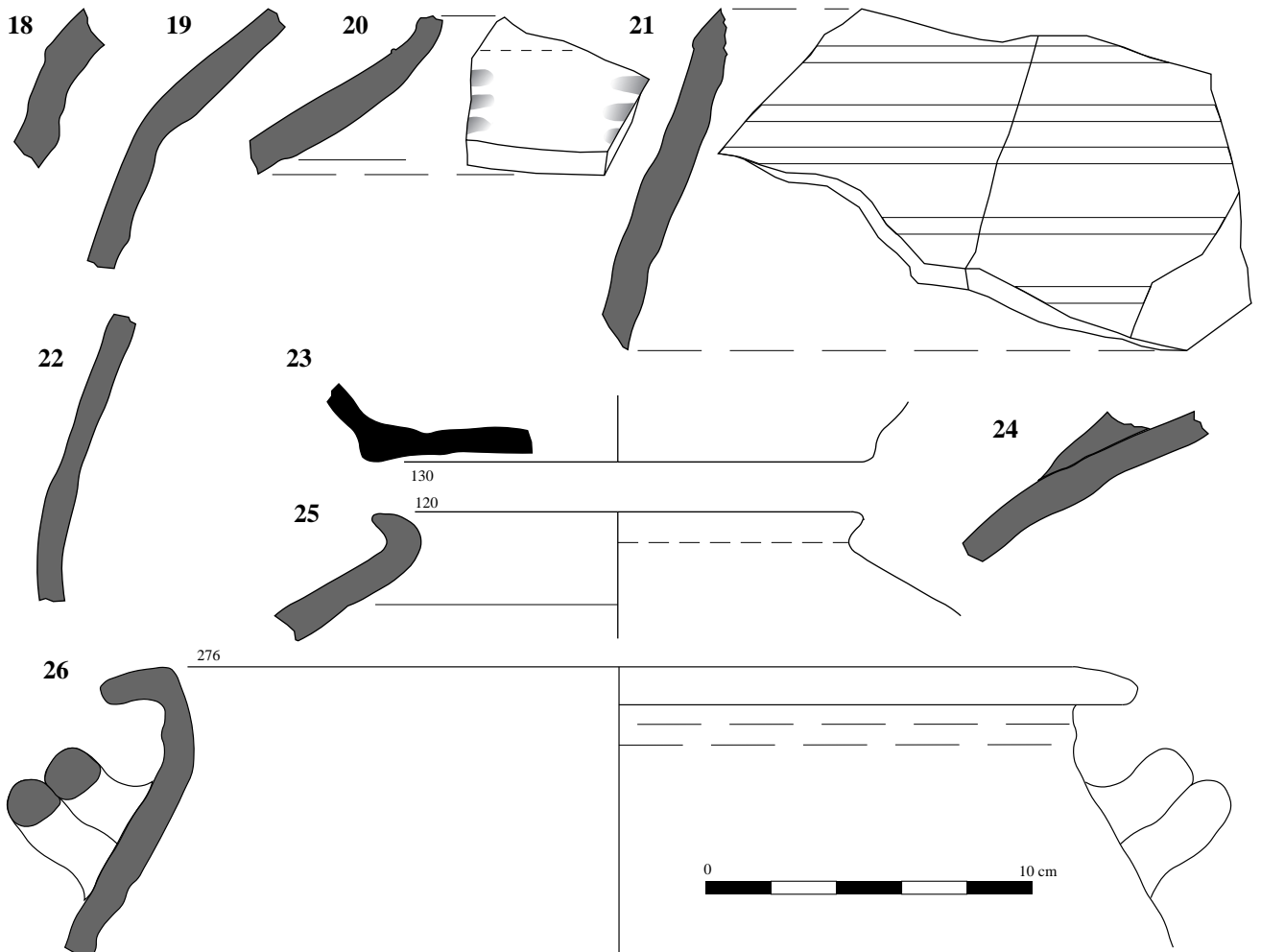

0 10 cm

Làm. 55: Ceràmica ibèrica, grega i fenícia dels jaciments de Turó de Xalamera [96], Roca dels Penjats [85], lo Toll [88] (Benifallet), i les Trampes [98] (Xerta).

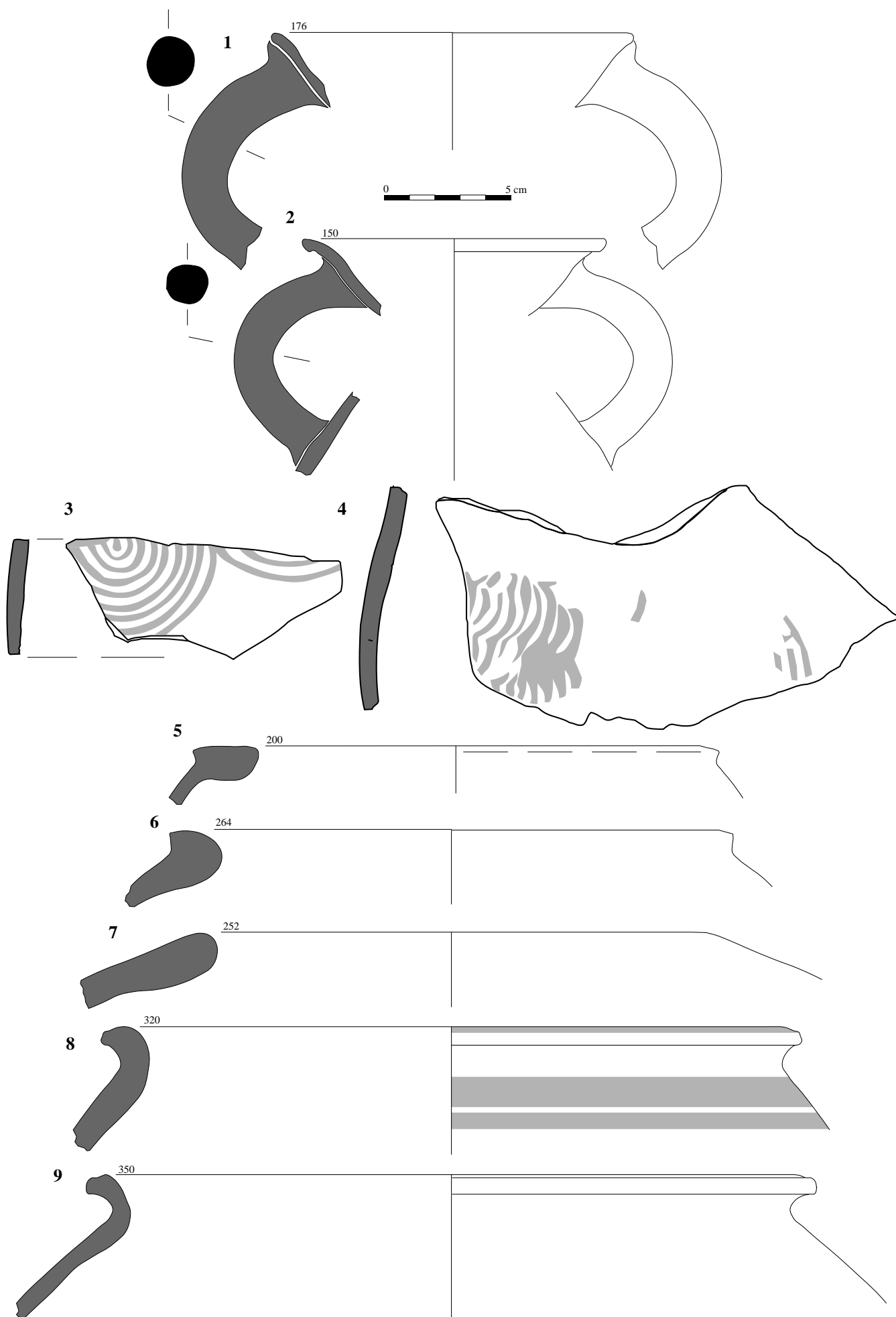

Làm. 56: Ceràmica ibèrica oxidada del Turó de l'Audí [86] (Benifallet).

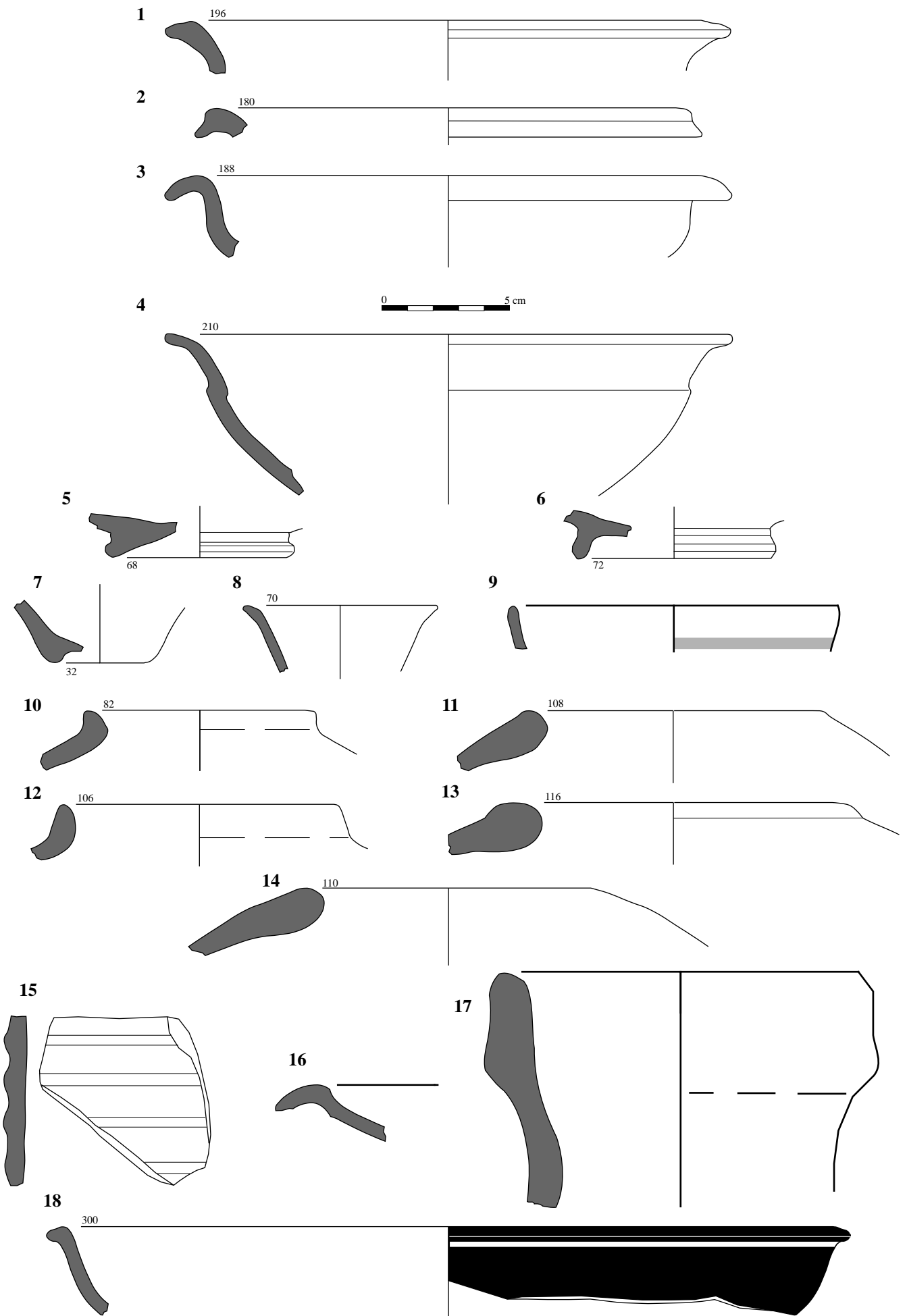

Làm. 57: Ceràmica a torn del jaciment del Turó de l'Audí [86] (Benifallet).

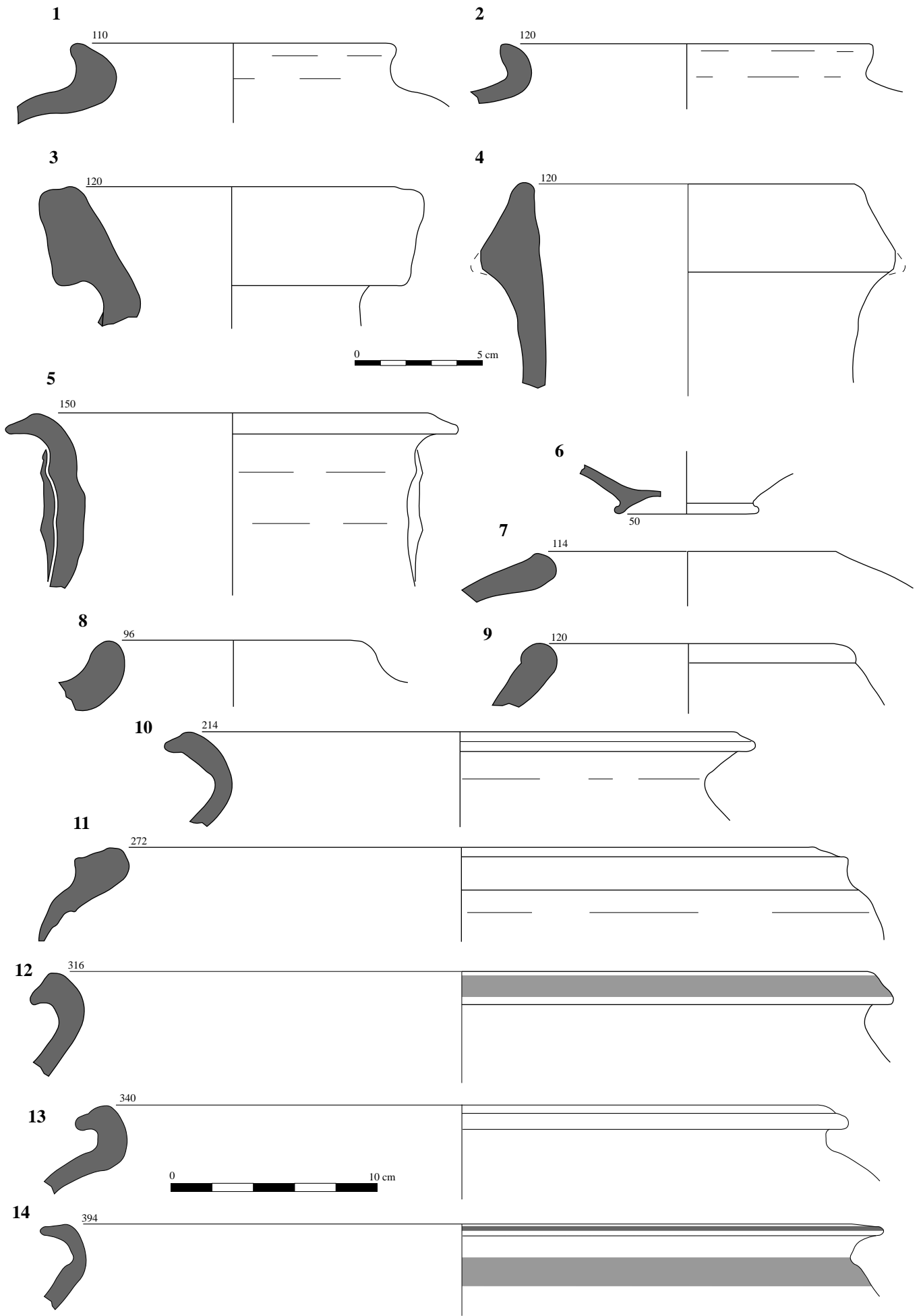

Làm. 58: Ceràmica fenícia, ibèrica i romana del jaciment del Martorell [90] (Benifallet).

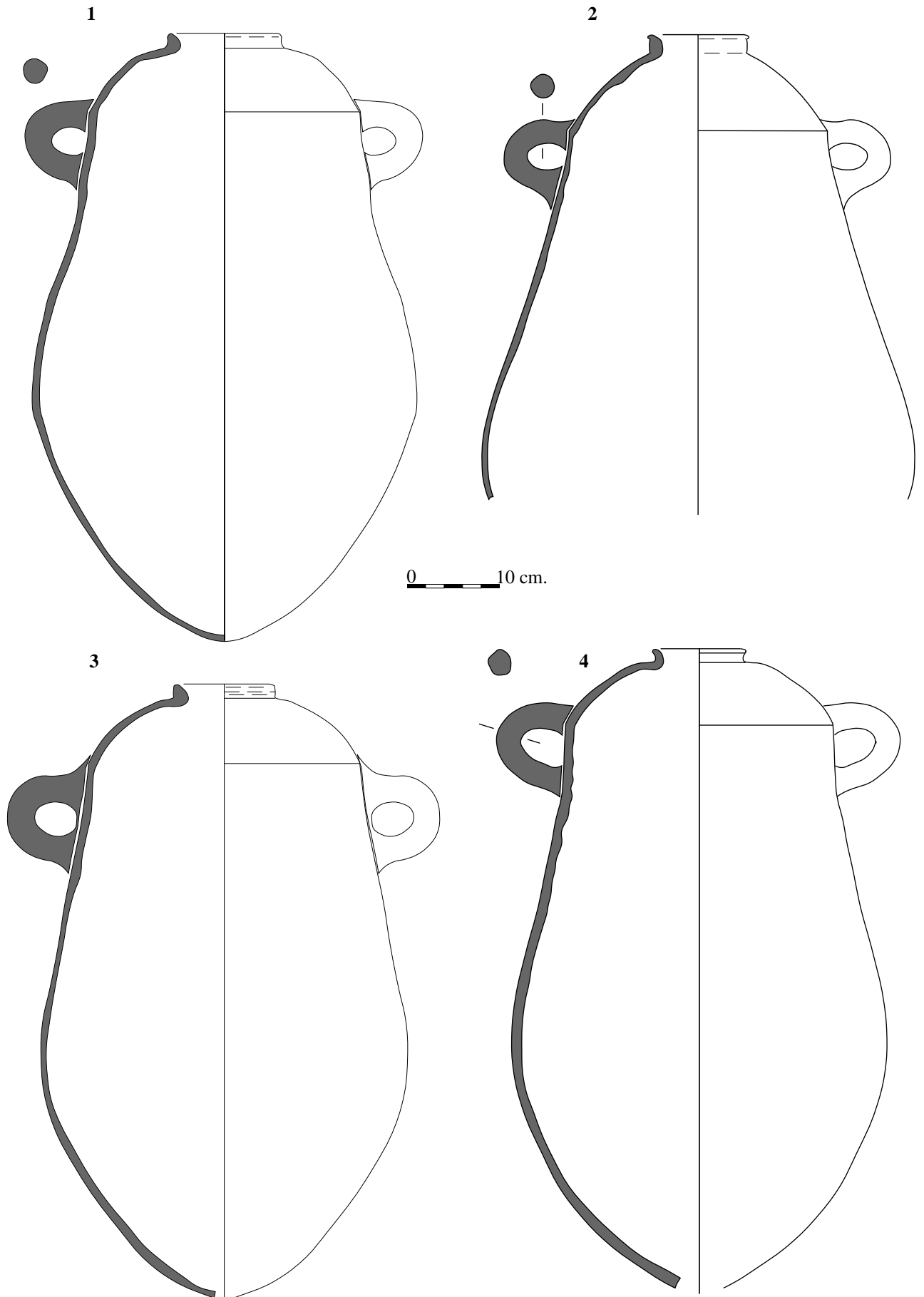

Làm. 59: Àmfores fenícies del jaciment d'Aldovesta [92] (Benifallet).

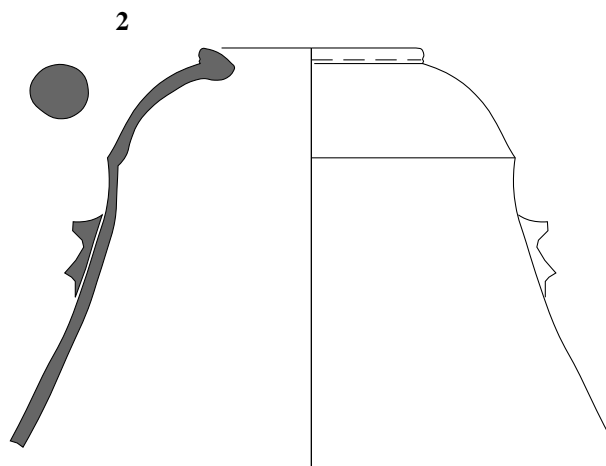
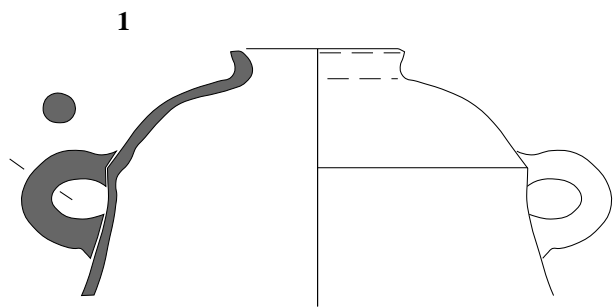

0 10 cm.

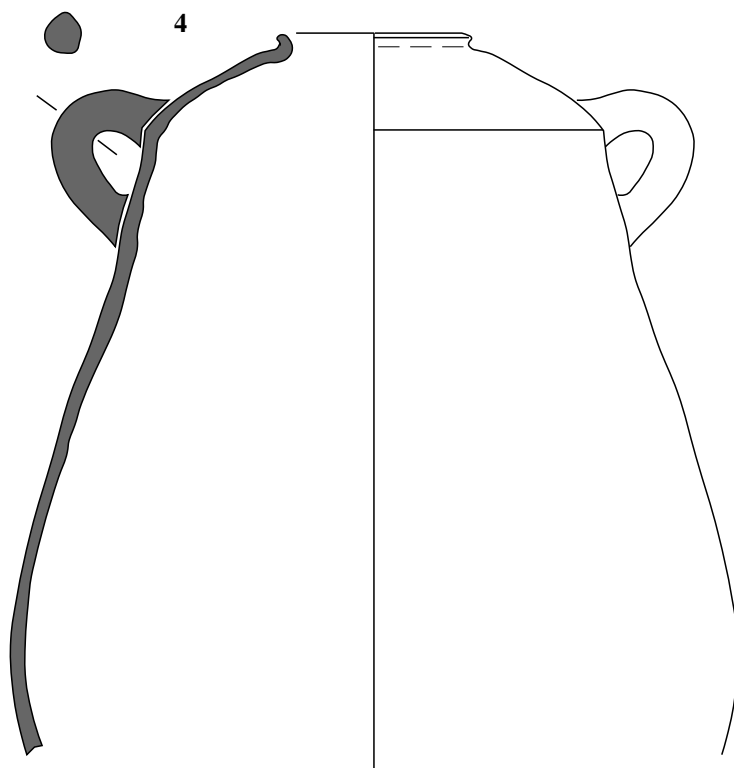
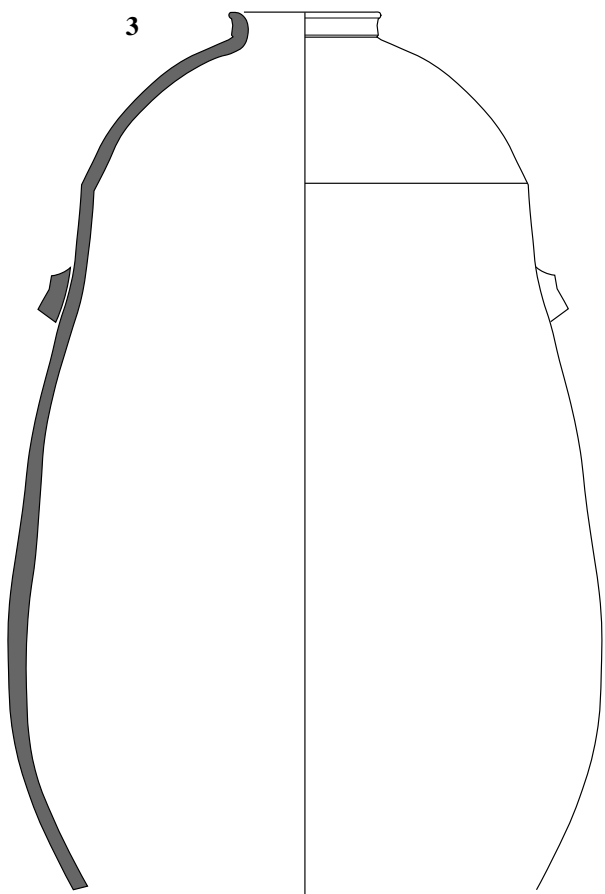

Làm. 60: Àmfores fenícies del jaciment d'Aldovesta [92] (Benifallet).

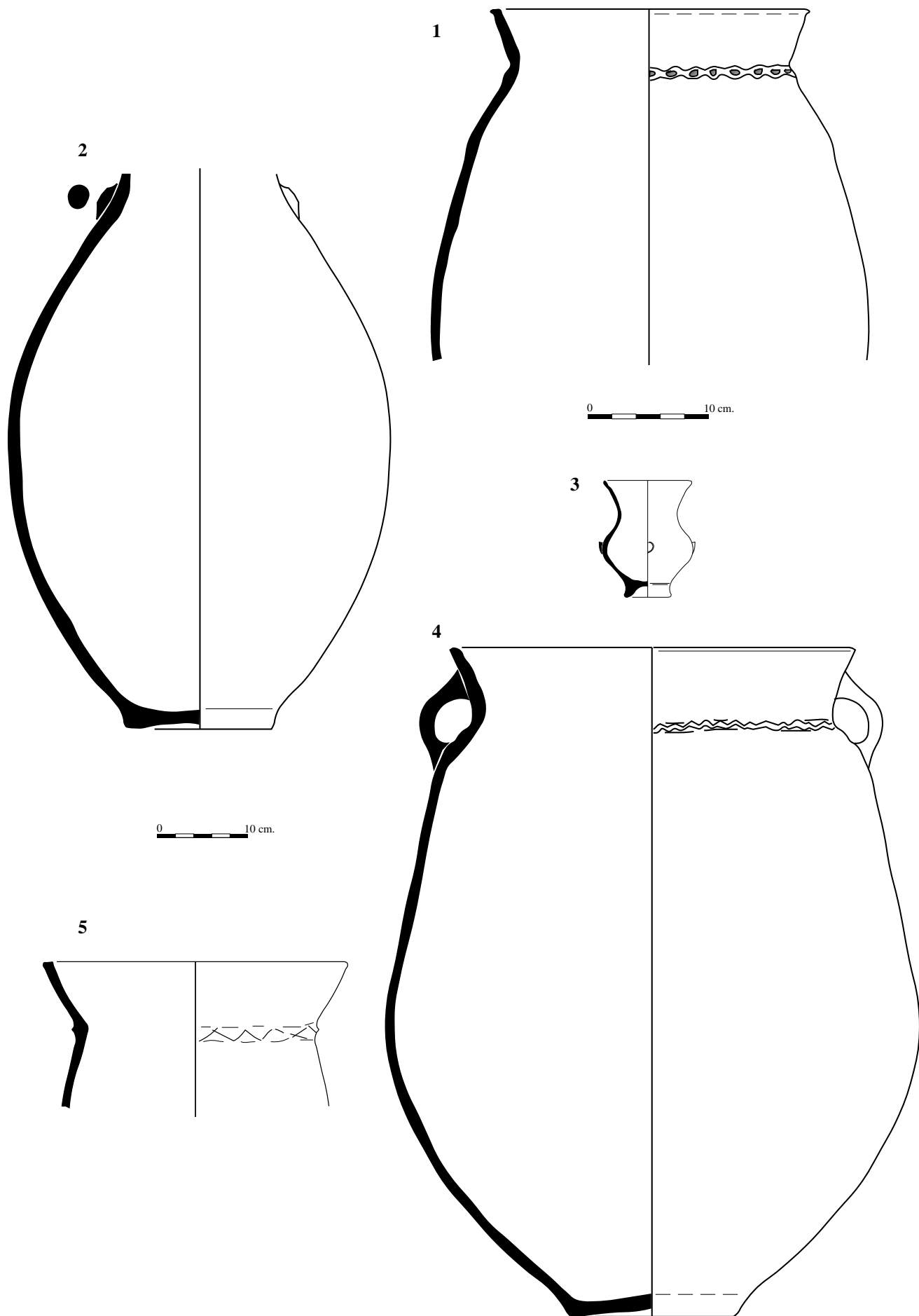

Làm. 61: Ceràmiques a mà del jaciment d'Aldovesta [92] (Benifallet).

cata 2 - nivell 1

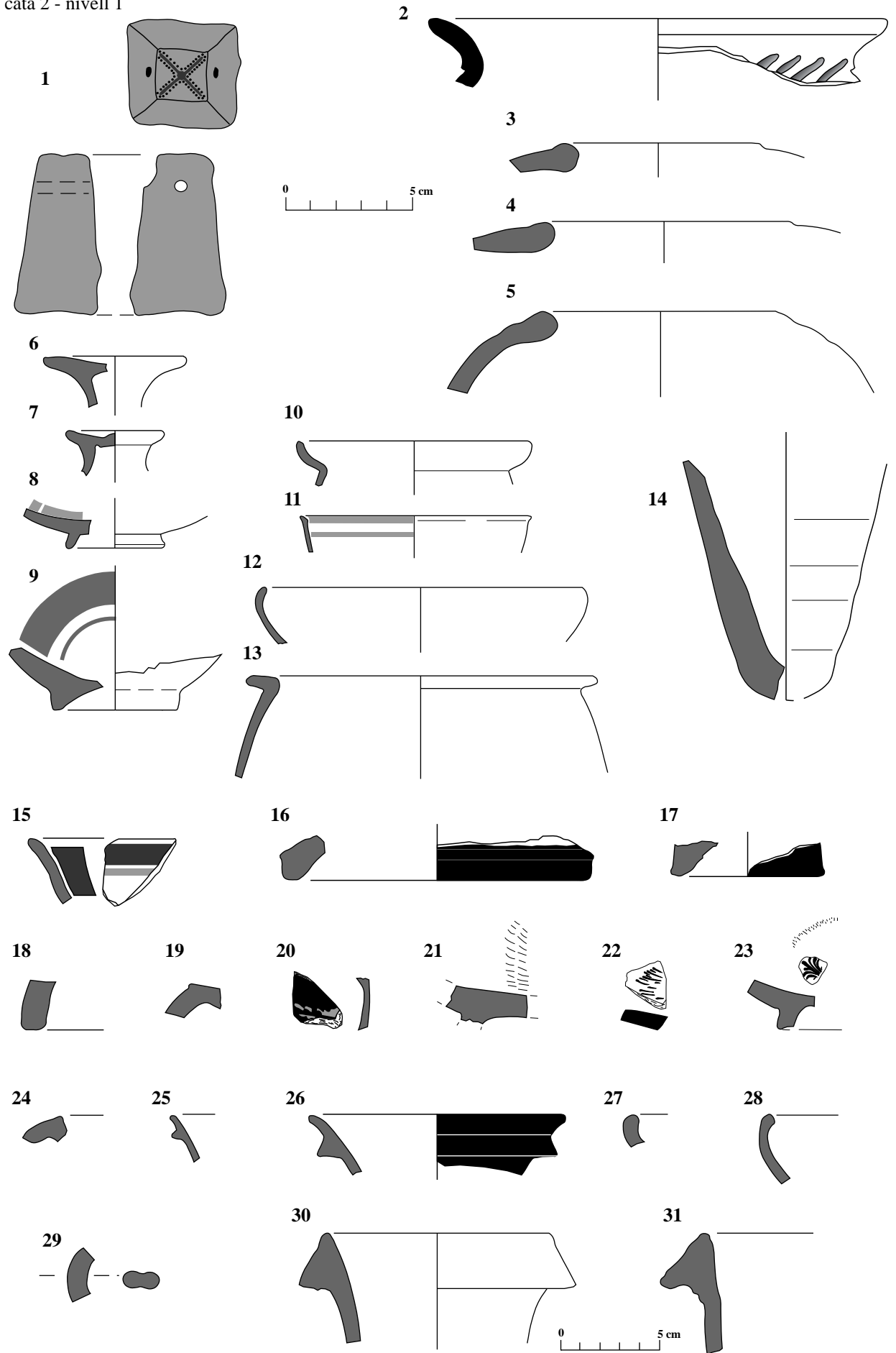

Làm. 62: Material arqueològic procedent de la campanya de 1974 del Castellot de la Roca Roja [94] (Benifalset), dipositat en el Museu Arqueològic de Catalunya.



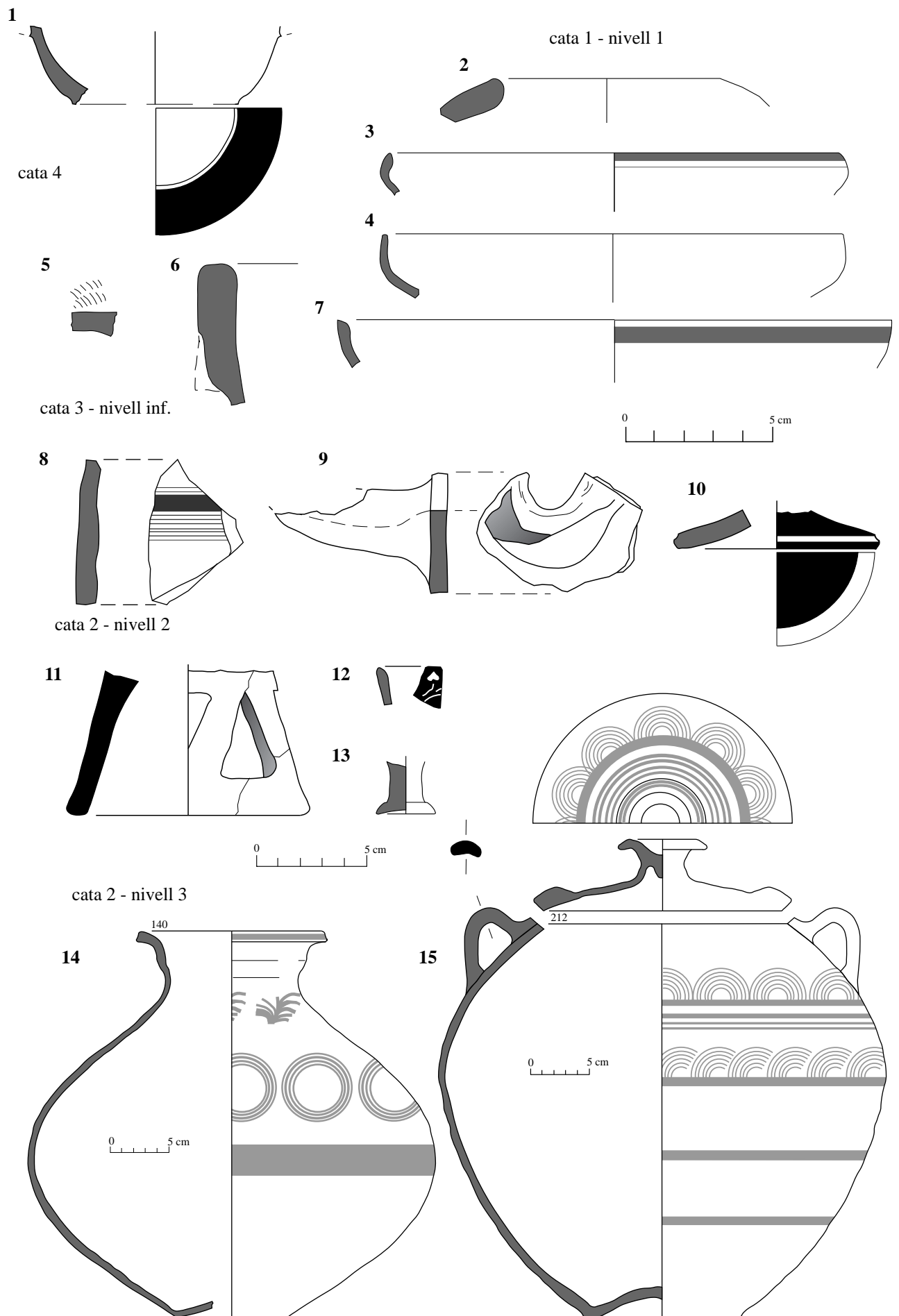

Làm. 63: Material arqueològic procedent de la campanya de 1974 del Castellot de la Roca Roja [94] (Benifalset), dipositat en el Museu Arqueològic de Catalunya.

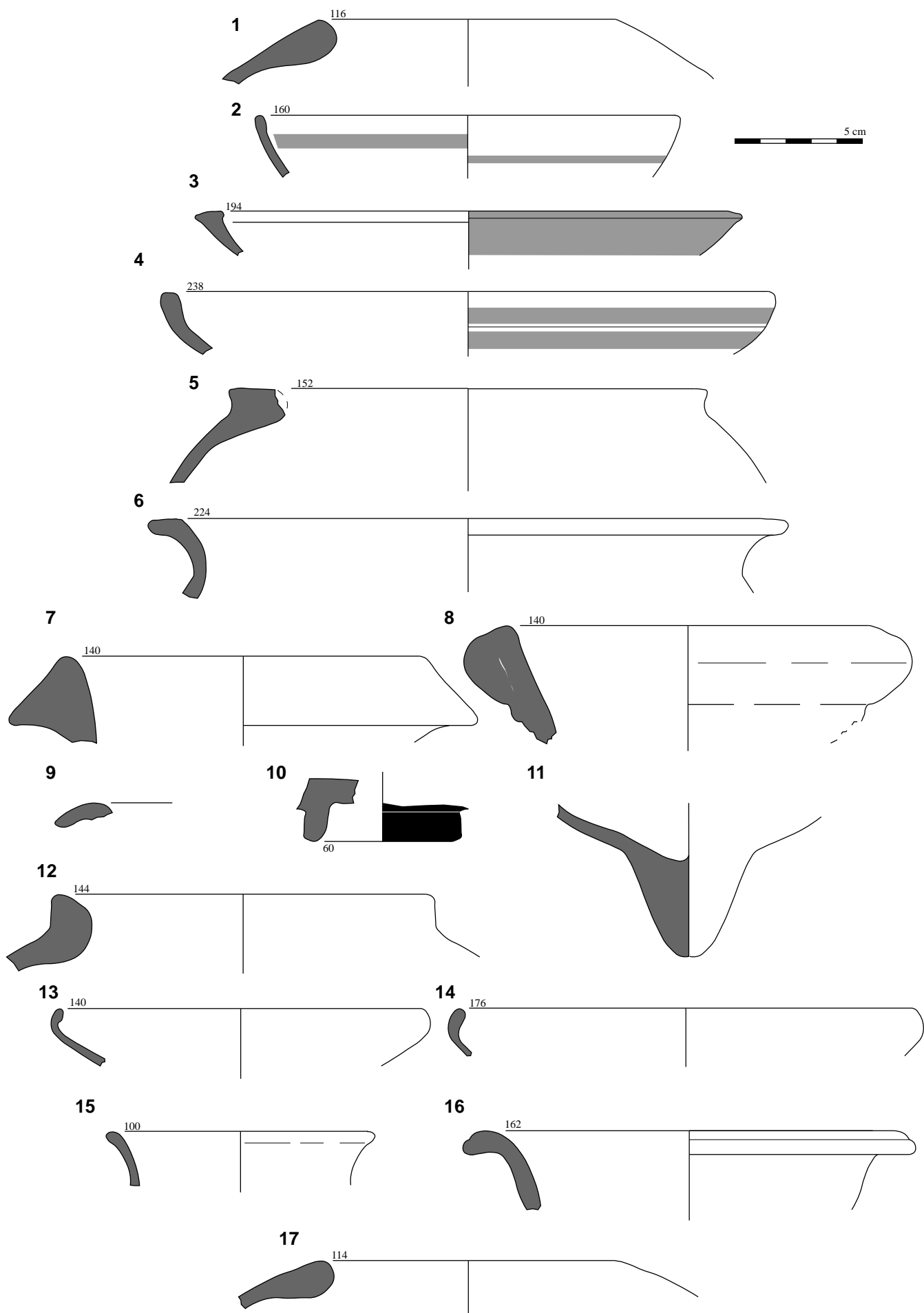

Làm. 64: Material superficial recollit en el Castellot de la Roca Roja [94] (Benifallet), durant la campanya de 1998.

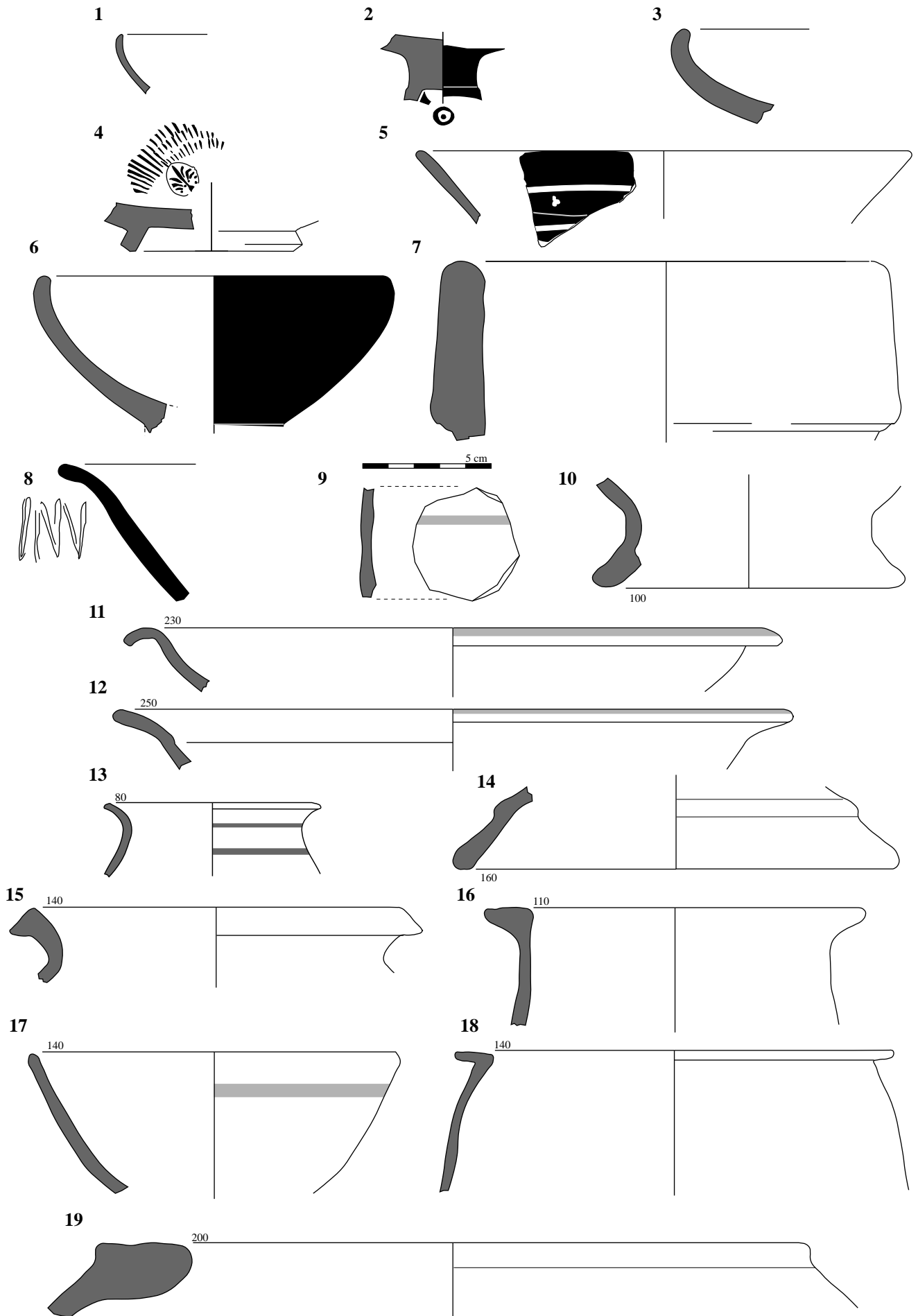

Làm. 65: Materials d'importació superficials, i ceràmiques de l'ibèric ple del sector 13 de la zona 3 del Castellot de la Roca Roja [94] (Benifallet).

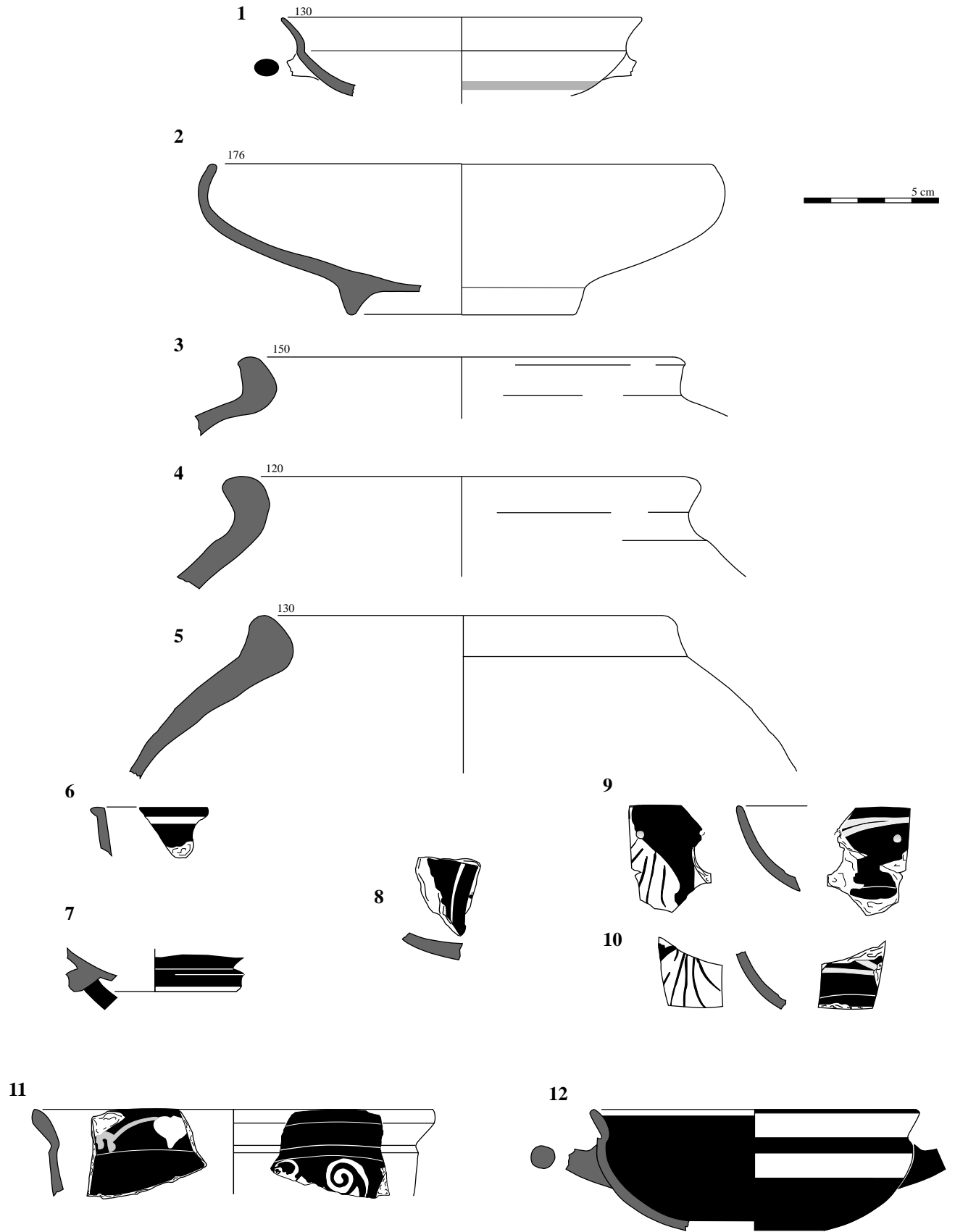

Làm. 66: 1-2. Imitacions ibèriques de ceràmiques de vernís negre; 3-5. Àmfores ibèriques. 6-11. Importacions àtiques del segle IV. 12. Copa jònica B2 del segle VI. Castellot de la Roca Roja [94] (Benifallet).

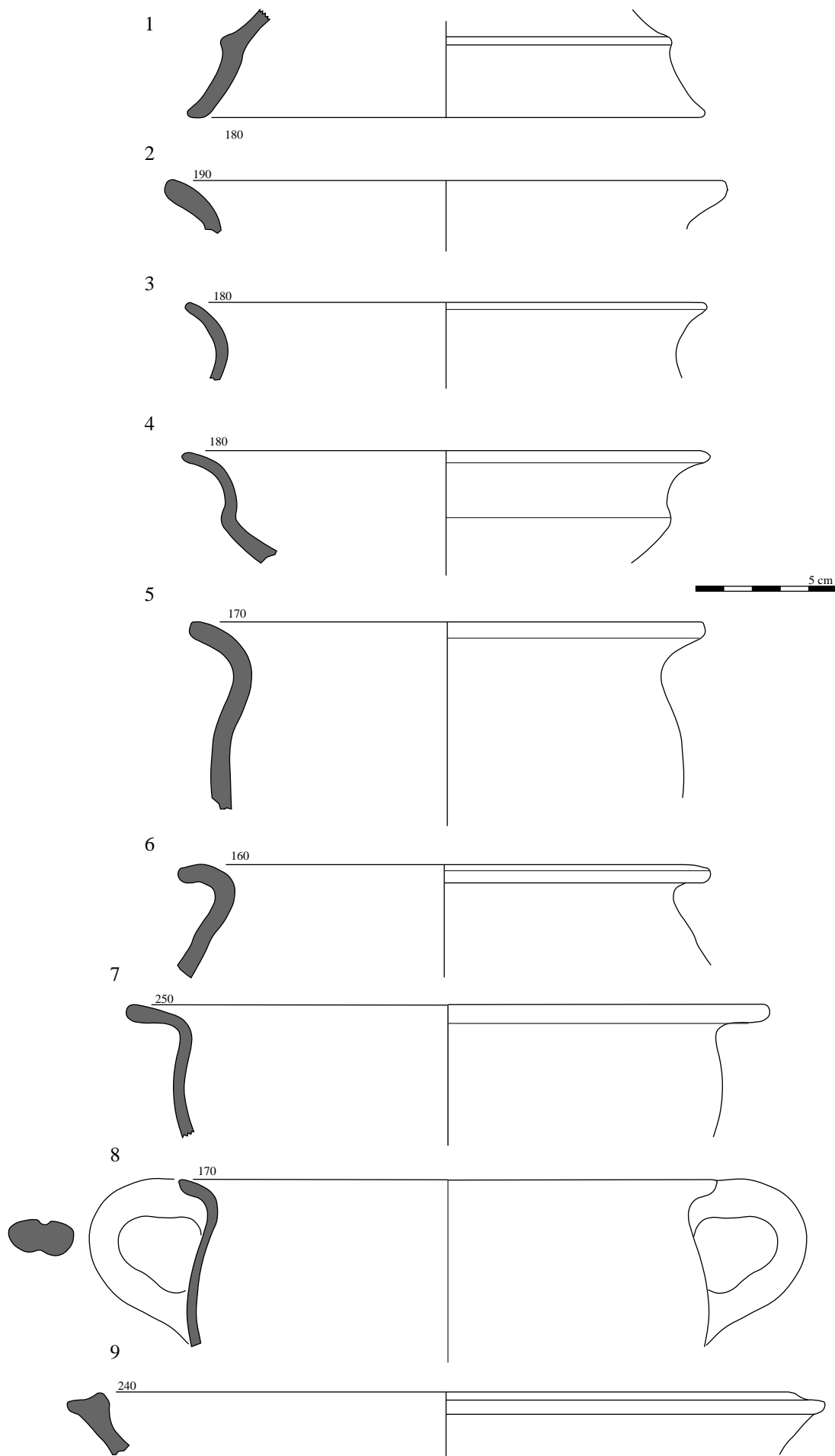

Làm. 67: Vaixel·la ibèrica oxidada del segle IV del Castellot de la Roca Roja [94] (Benifallet).

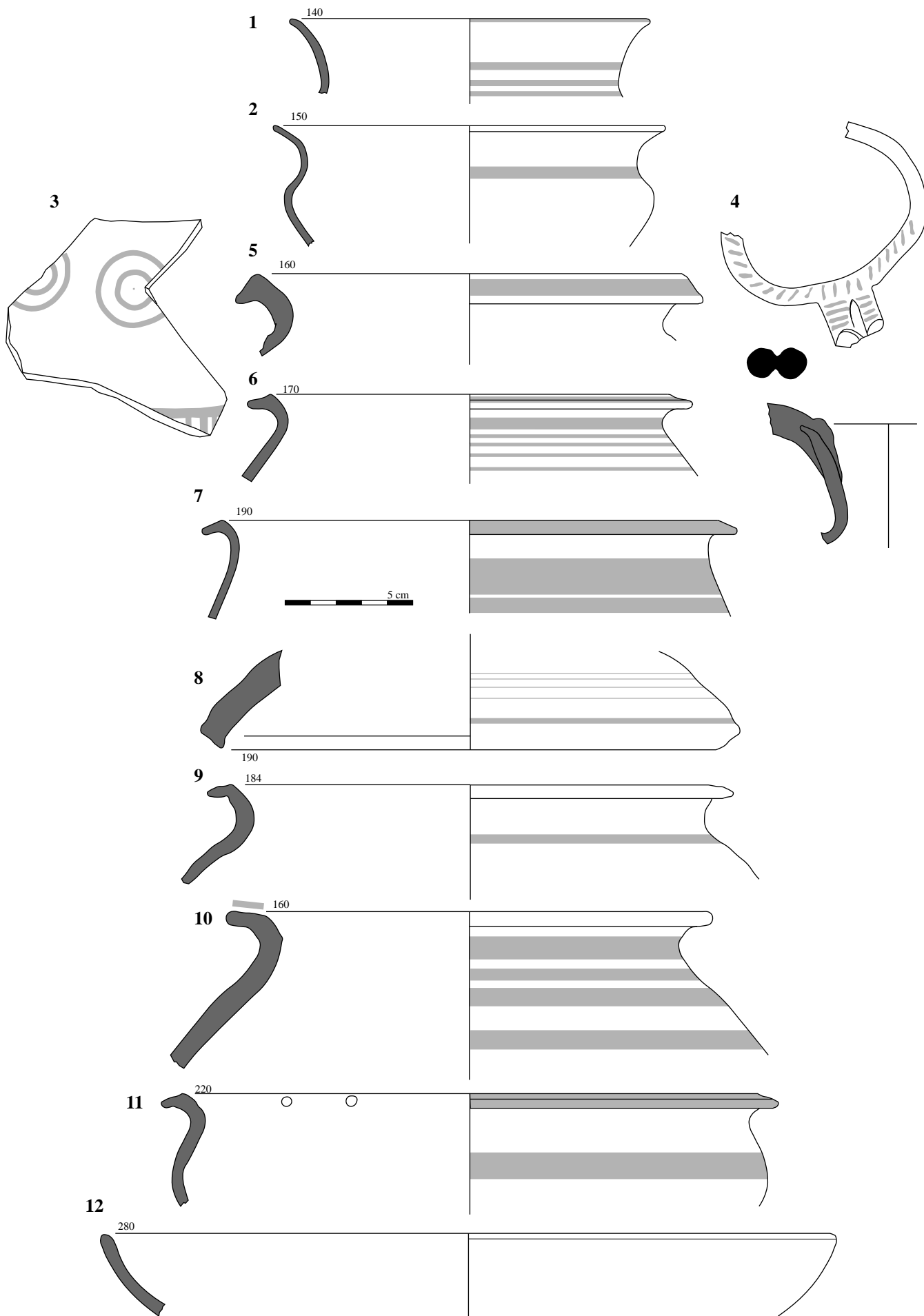

Làm. 68: Vaixel·la pintada ibèrica del segle IV del Castellot de la Roca Roja [94] (Benifallet).

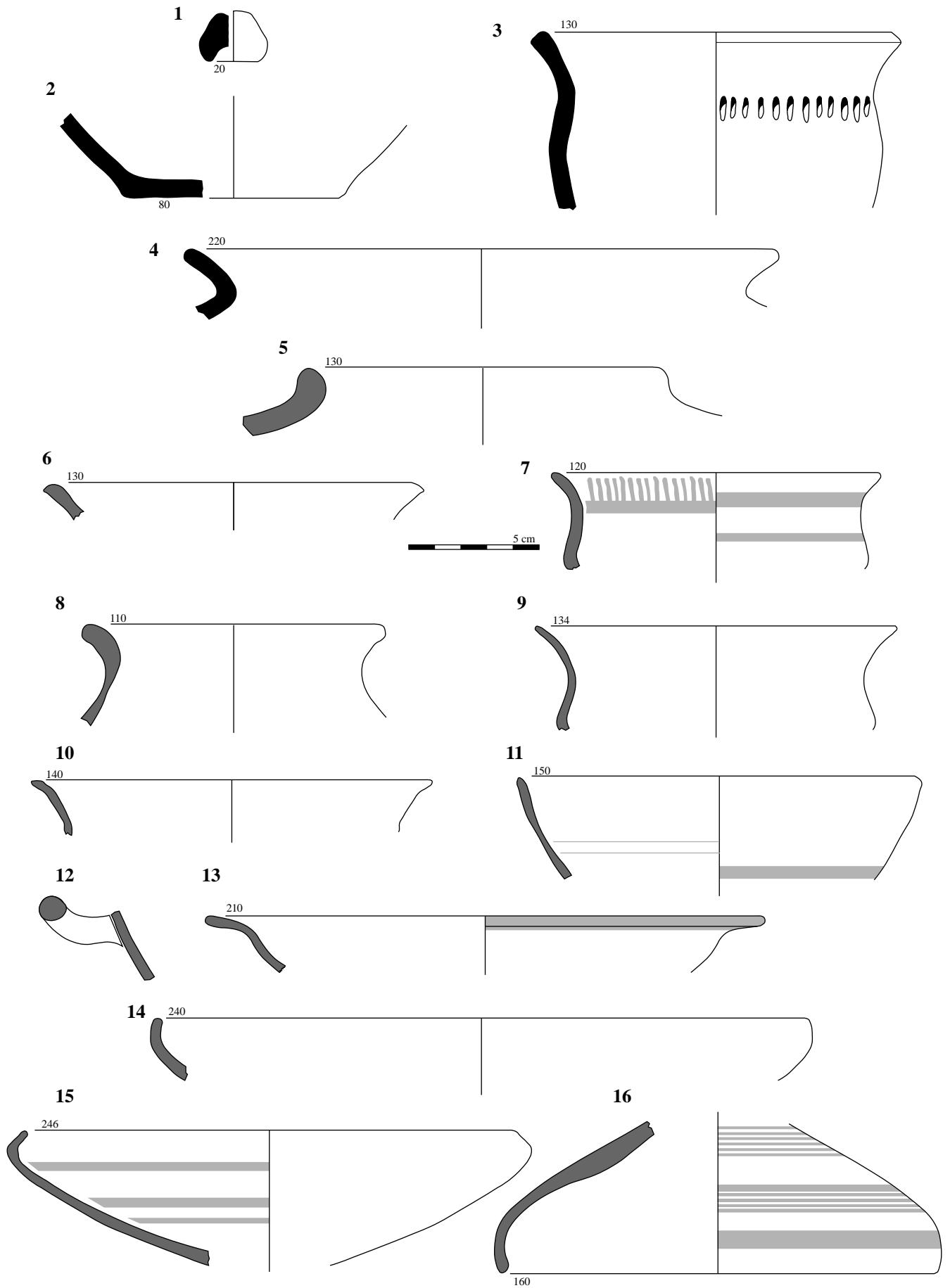

Làm. 69: Materials ceràmics de finals del segle V i del segle IV del Castellot de la Roca Roja [94] (Benifallet).

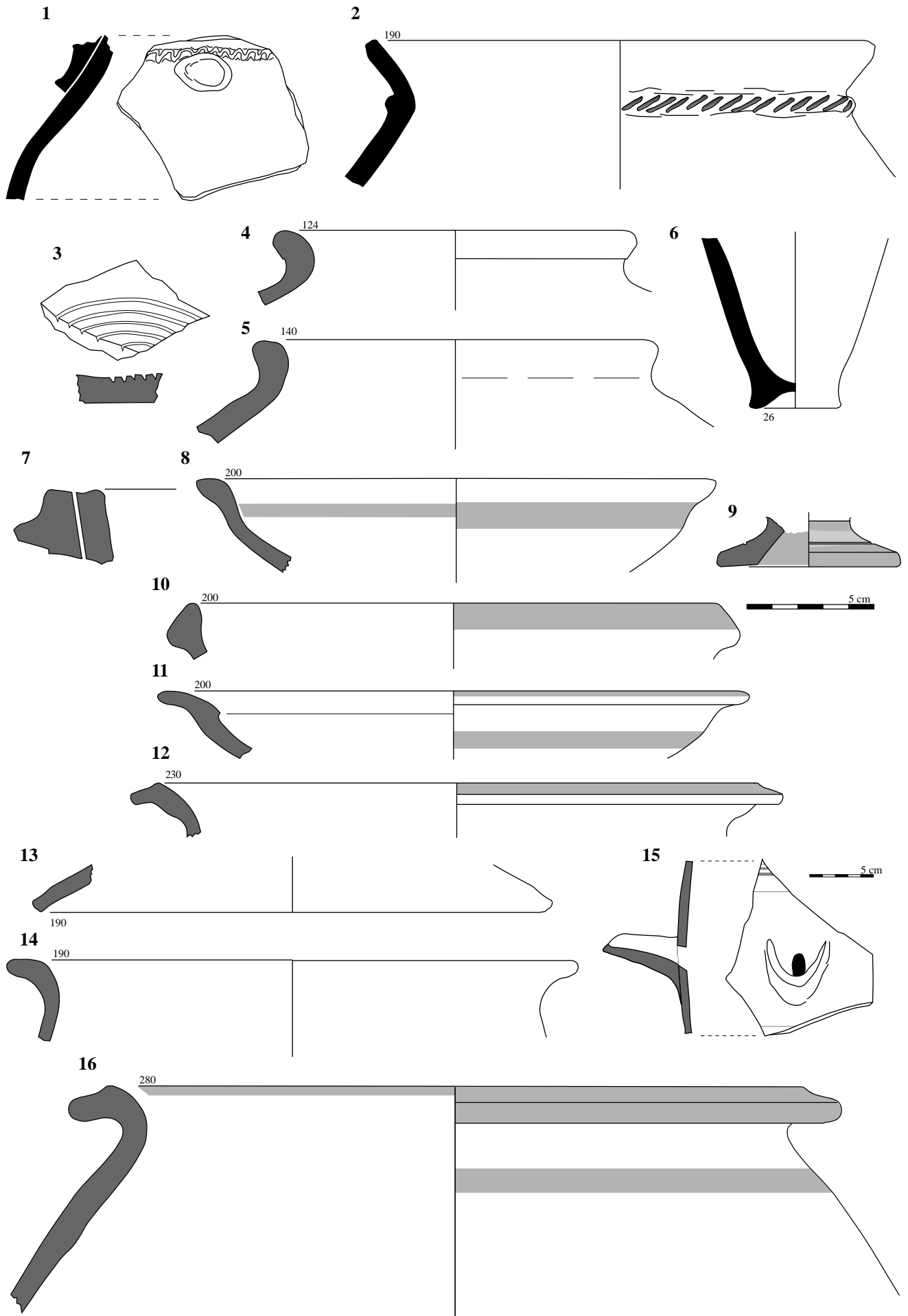

Làm. 70: Materials ibèrics antics del Castellot de la Roca Roja [94] (Benifallet).



Barranc de les Fonts

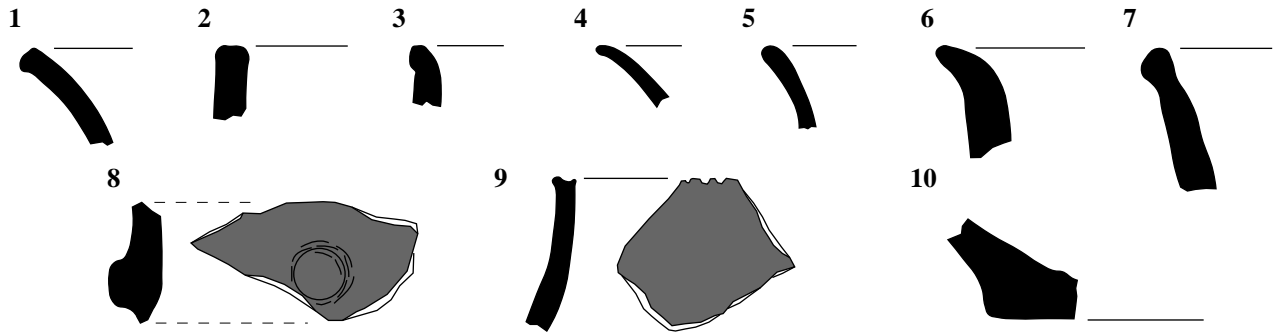

Barranc Fondo

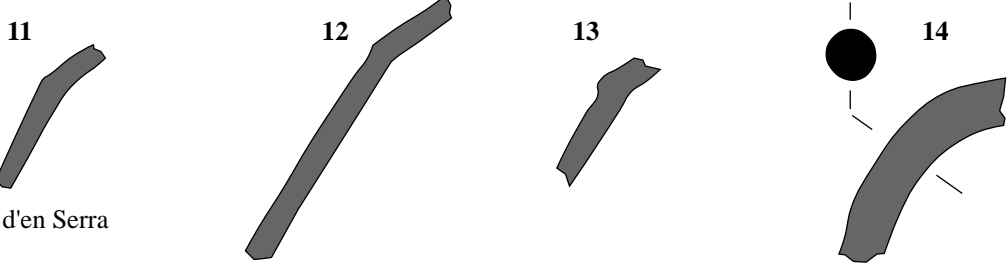

Turó d'en Serra

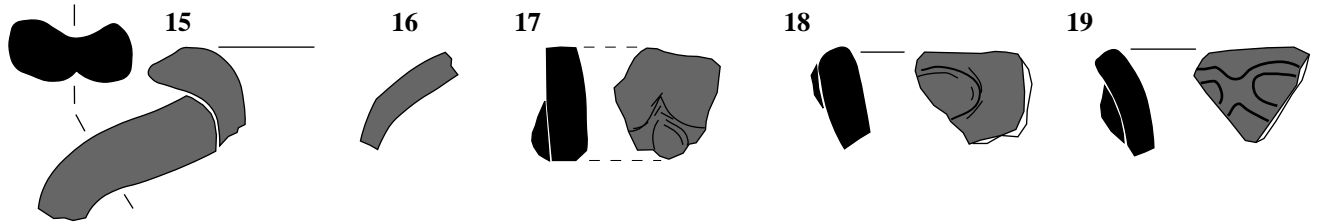

Coll de Som

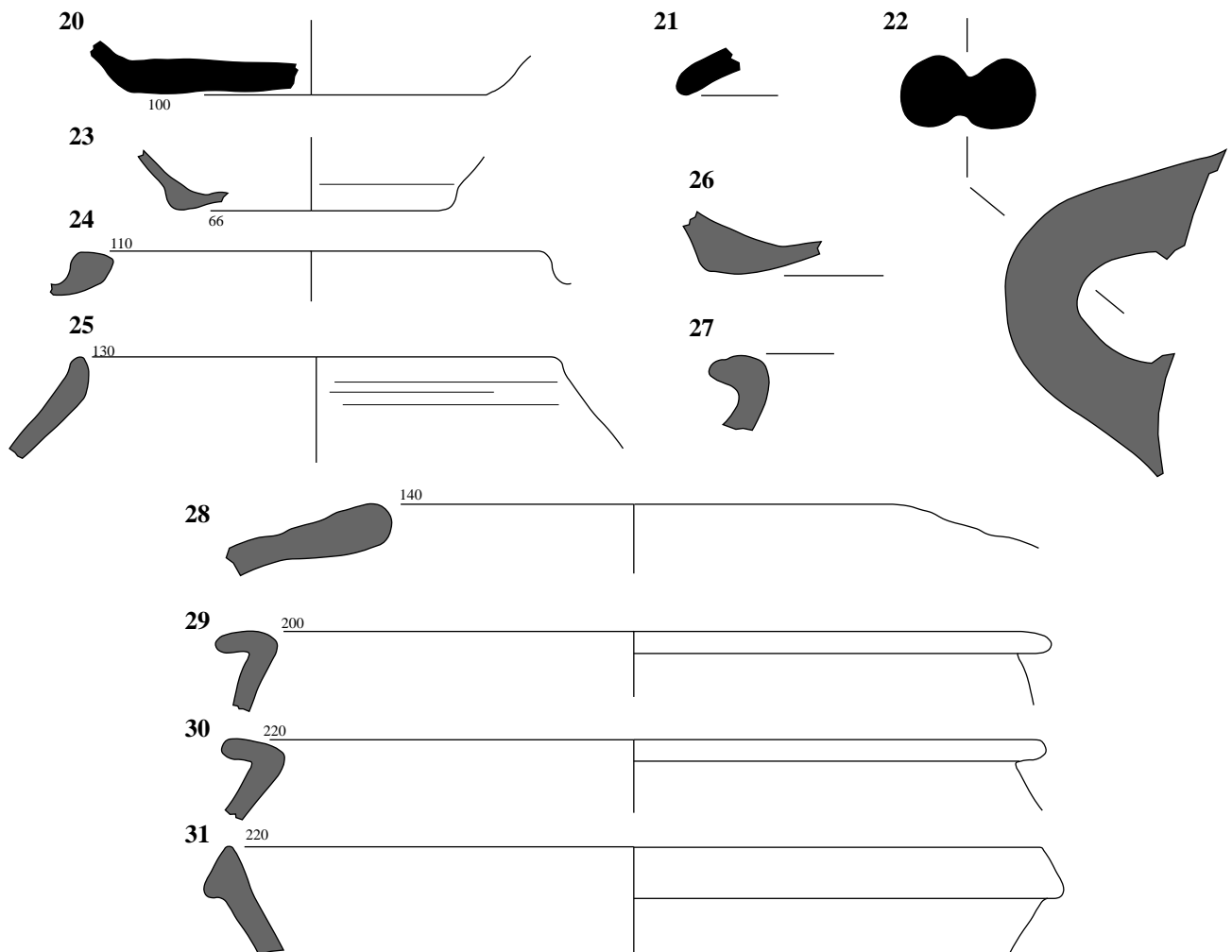

Làm. 71: Ceràmica a mà, ceràmiques fenícies i ceràmica ibèrica oxidada dels jaciments del Barranc de les Fonts [100] (Xerta), Barranc Fondo [102], Turó d'en Serra [105] i Coll de Som [99] (Tivenys).

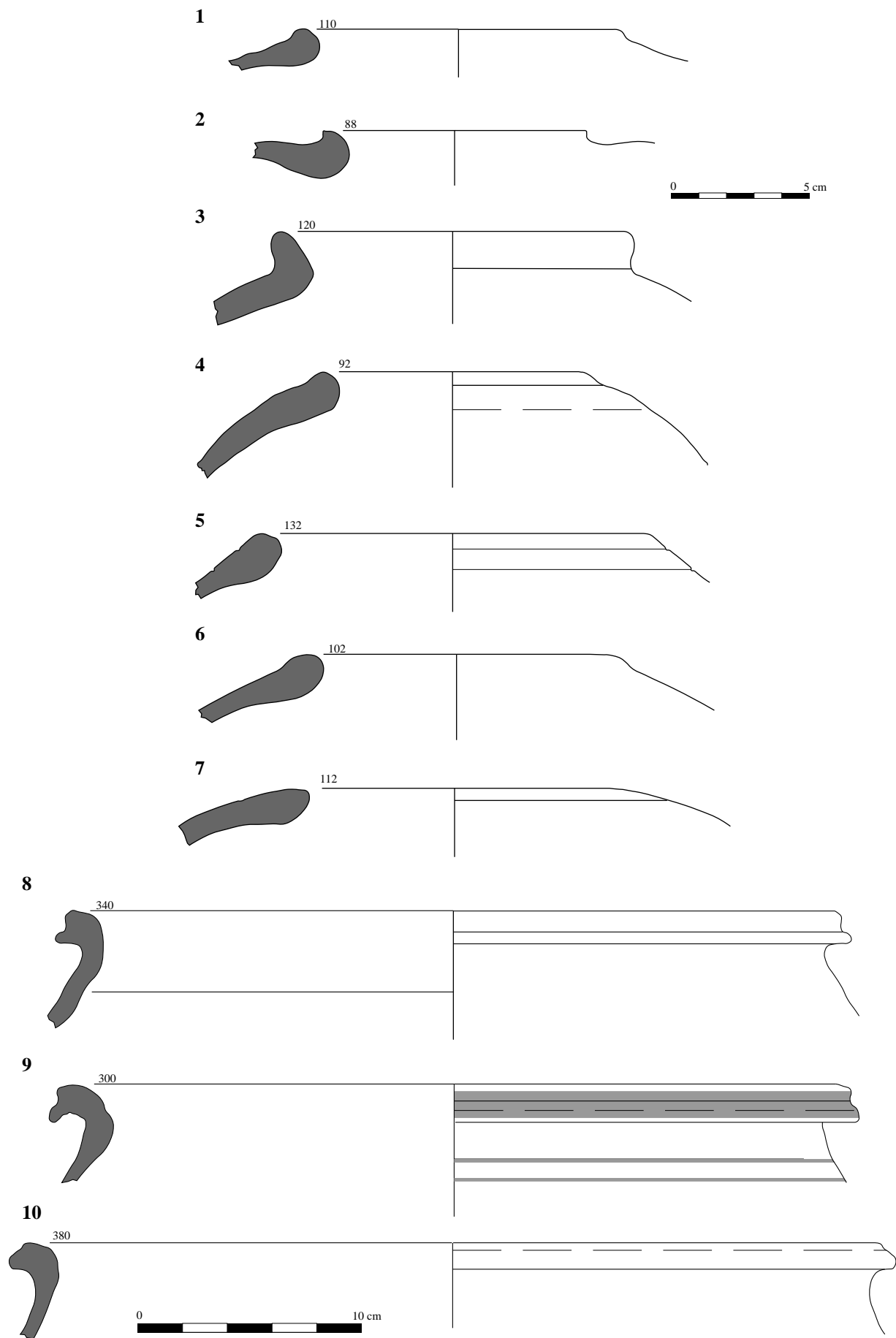

Làm. 72: Grans contenidors ibèrics del poblat de l'Assut [101] (Tivenys).

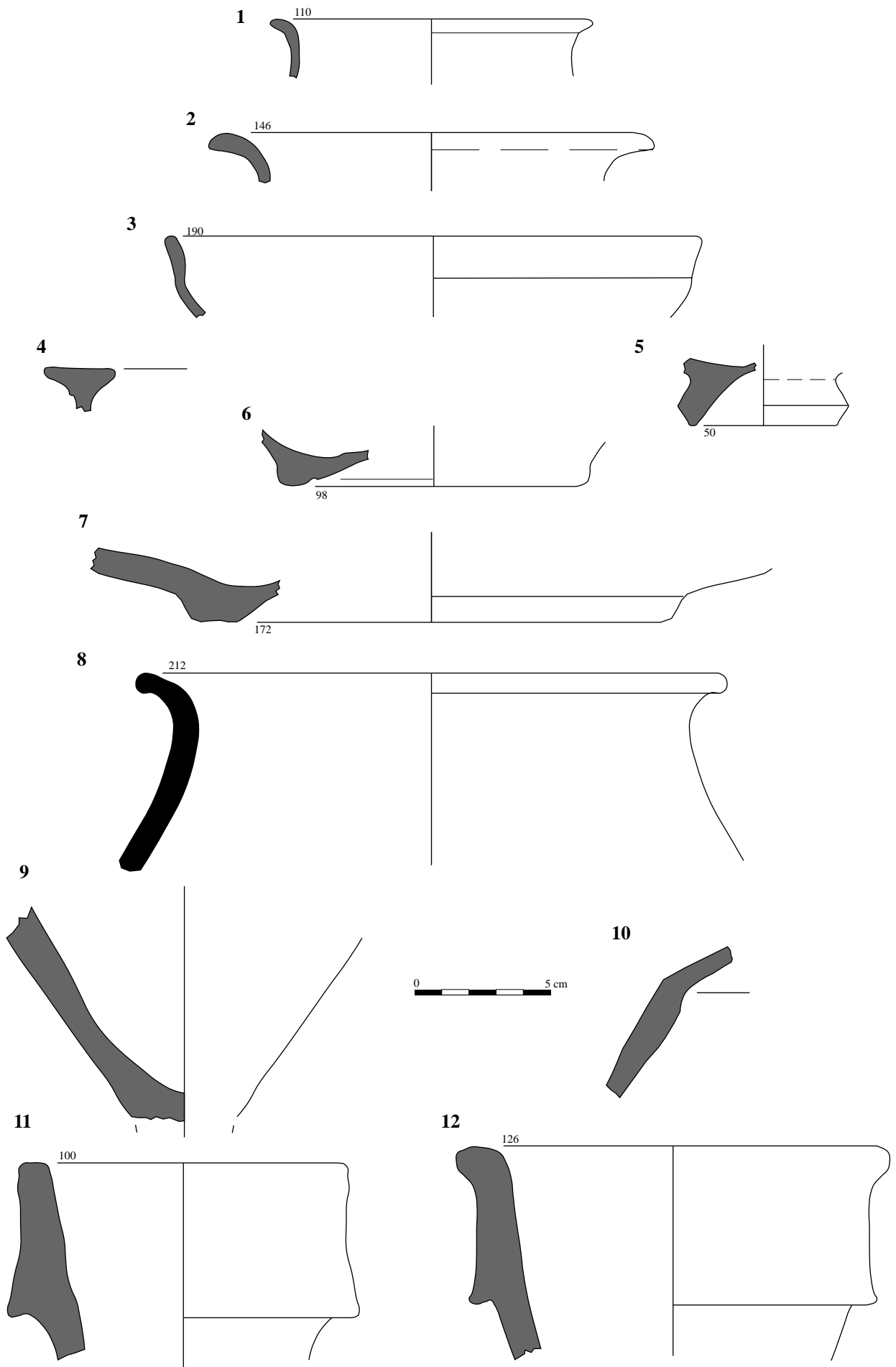

Làm. 73: Ceràmica ibèrica oxidada, ceràmica a mà, àmfores fenícies i itàliques del poblat de l'Assut [101] (Tivenys).

Plana de Nelo

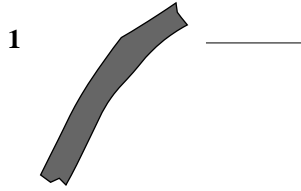

Plana de la Móra 2

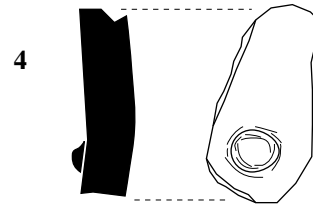
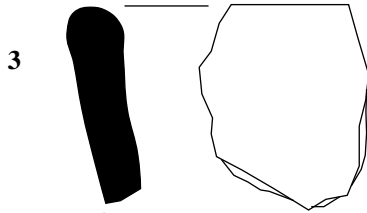

Barranc de Sant Antoni

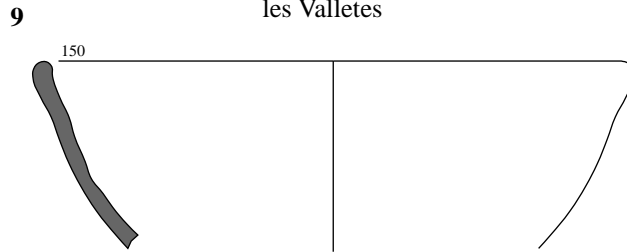
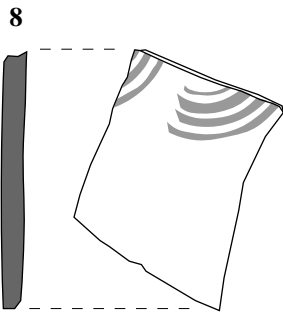
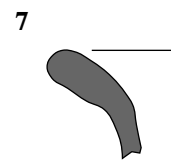
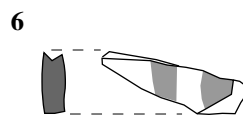
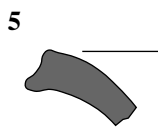

0 5 cm

les Valletes

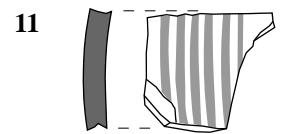
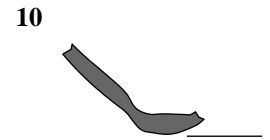

les Planetes

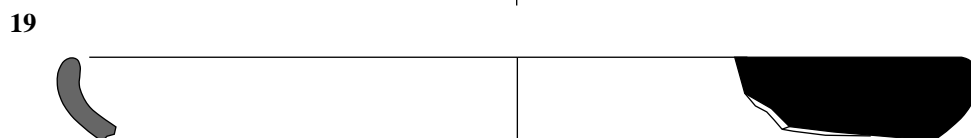
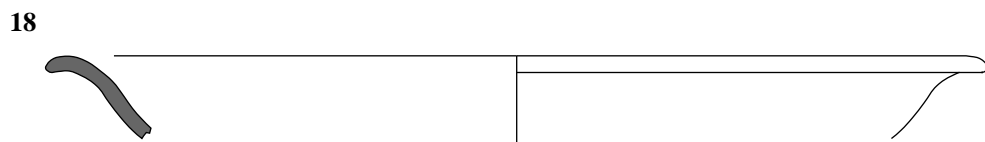
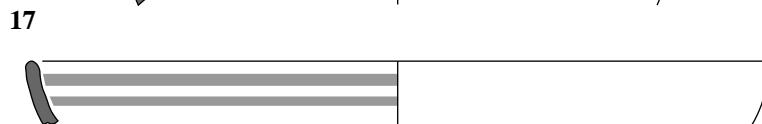
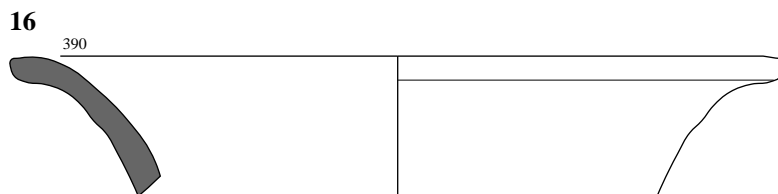
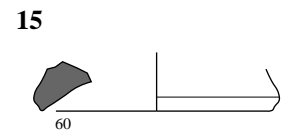
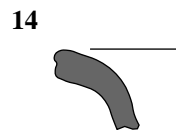
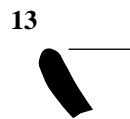
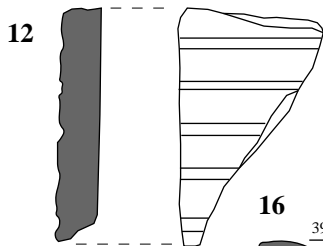

Làm. 74: Material arqueològic dels jaciments de Plana de Nelo [106], Plana de la Móra 2 [111] (Tivenys), Barranc de Sant Antoni [120] (Roquetes), les Valletes [115] (Aldover) i les Planetes [112] (Tortosa).

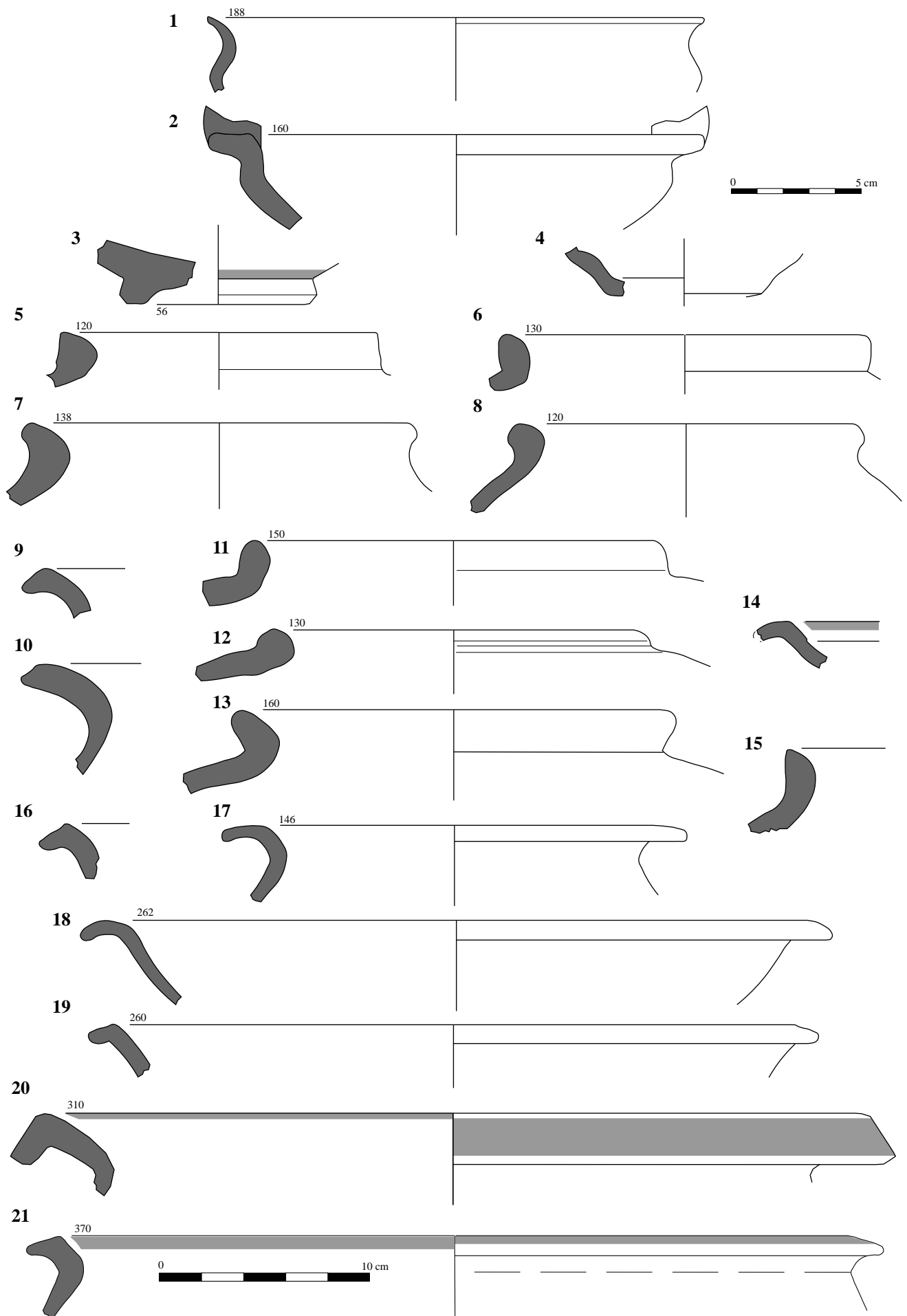

Làm. 75: Ceràmica ibèrica oxidada i àmfores fenícies del jaciment de la Punta de la Plana de la Móra [110] (Tivenys).

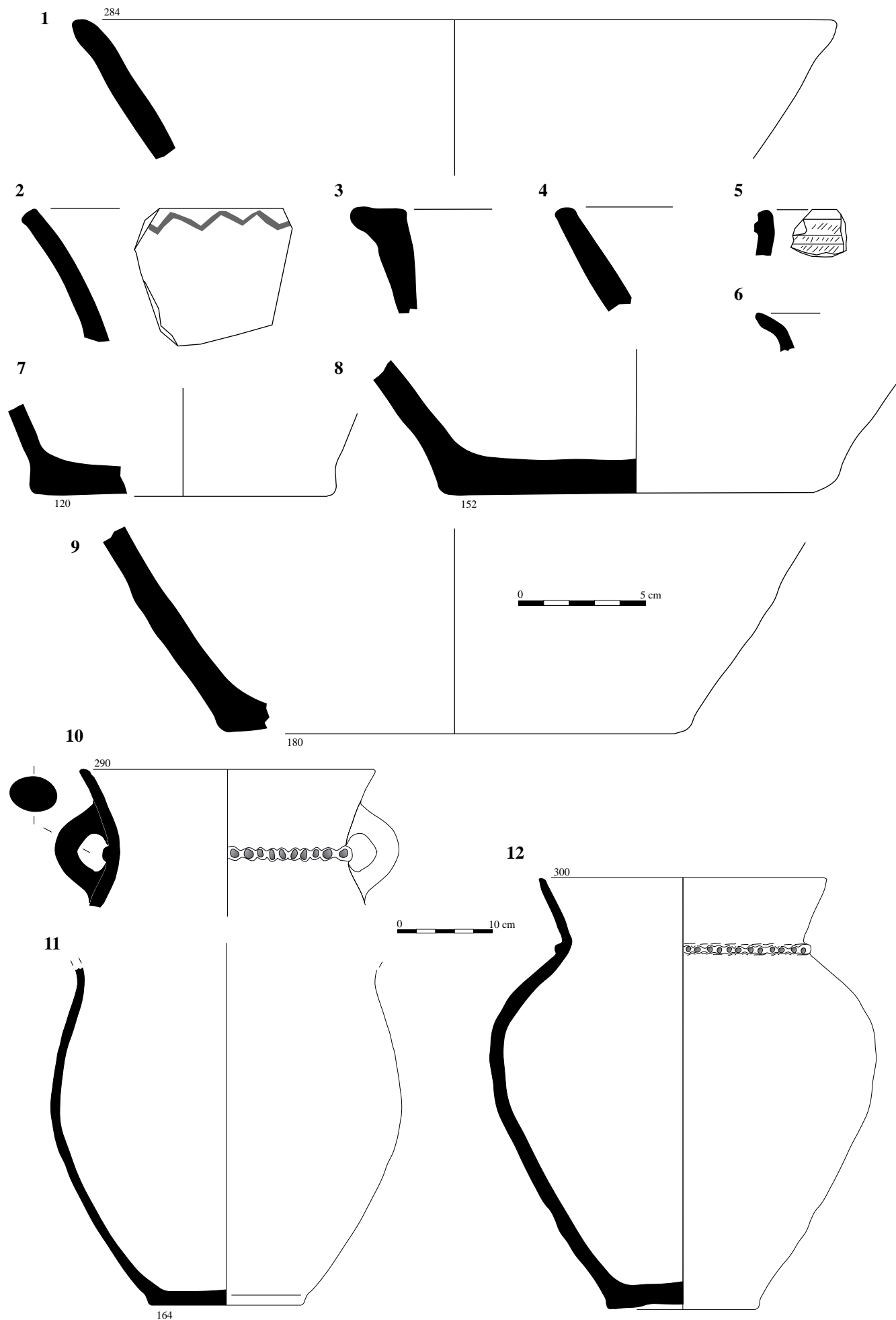

Làm. 76: Ceràmica a mà del jaciment dels Tossals [114] (Aldover).

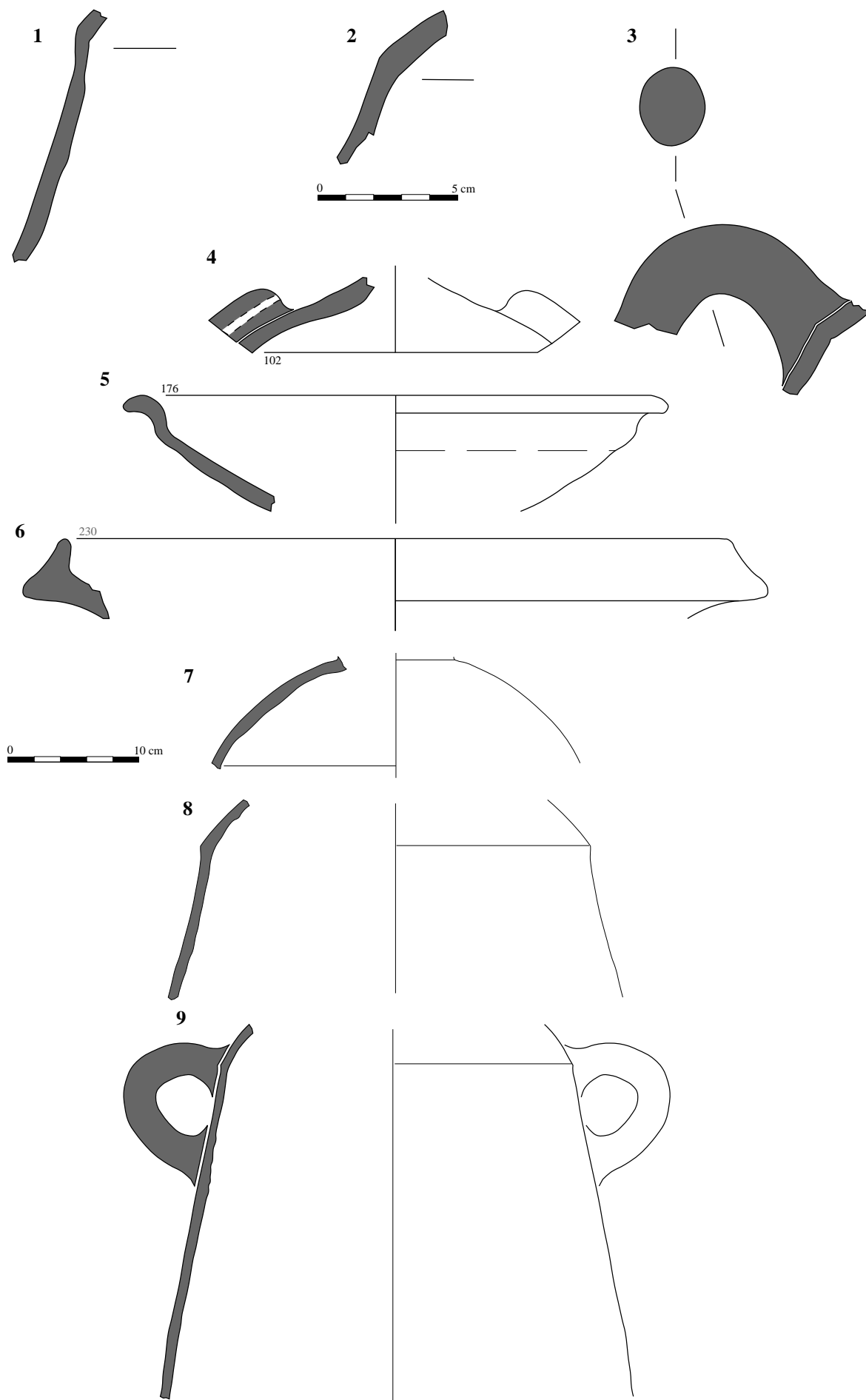

Làm. 77: Material ibèric antic i àmfores fenícies del jaciment dels Tossals [114] (Aldover).

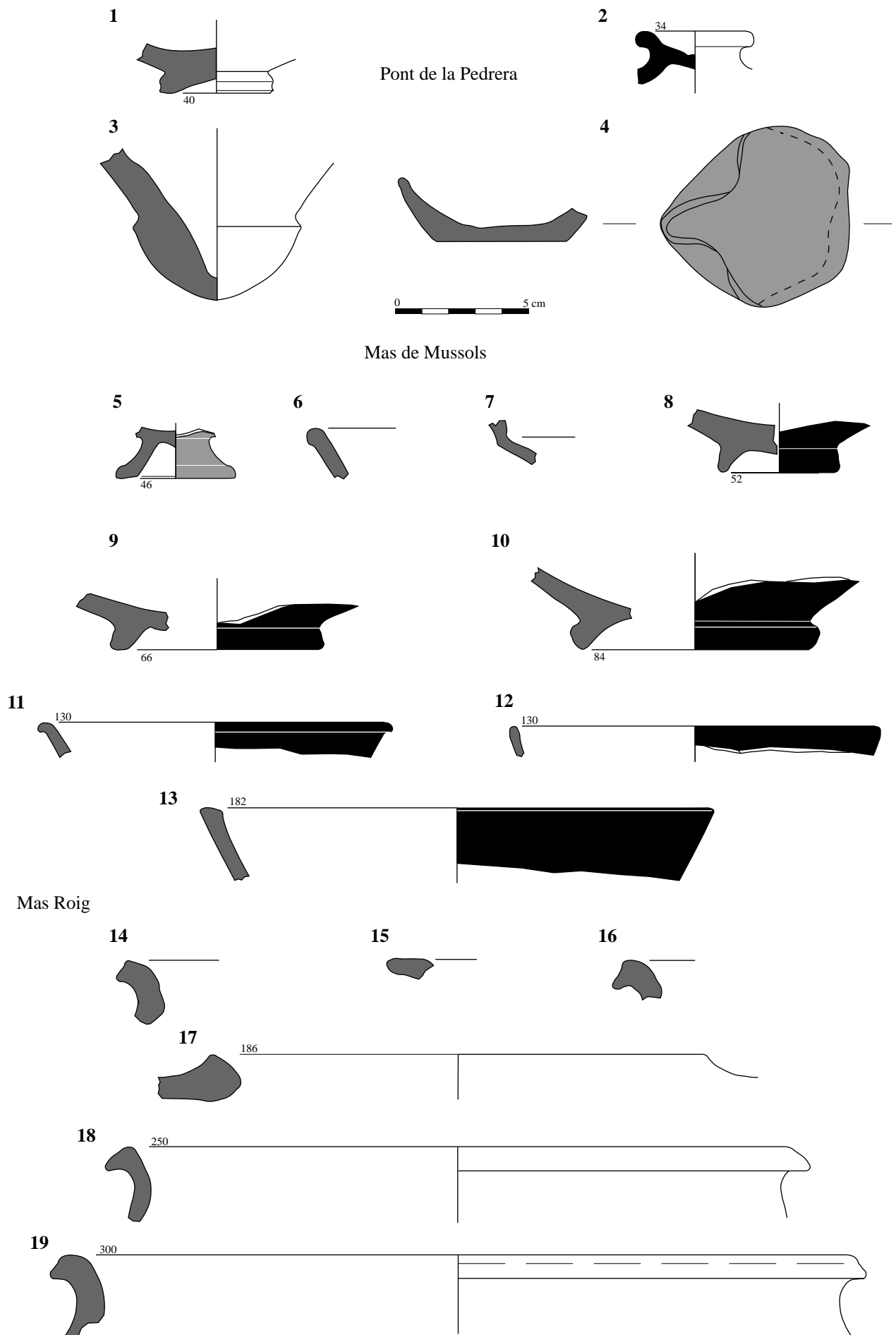

Làm. 78: Material ceràmic dels jaciments del Pont de la Pedrera [135], de Mas de Mussols [136] (l'Aldea) i Mas Roig [127] (Amposta).



Castellons 1

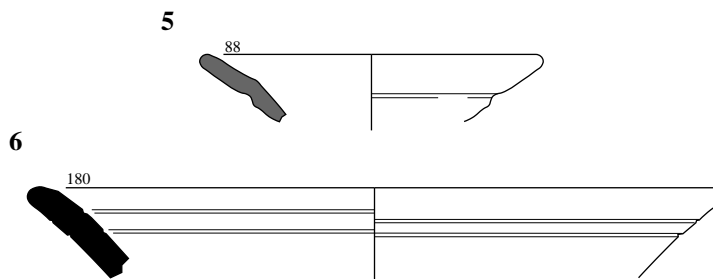

Barranc de Mosselló 2

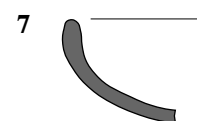

Barranc d'en Fabra

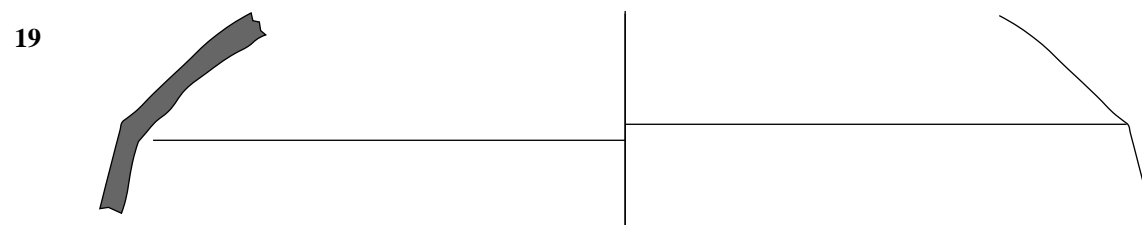
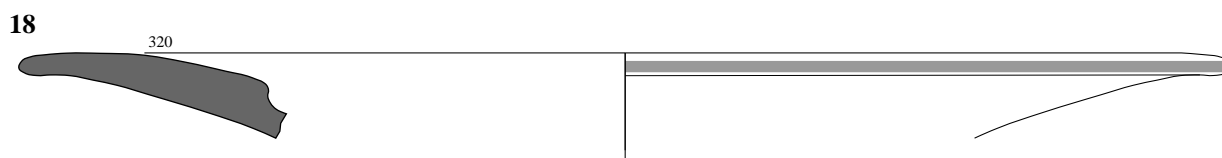
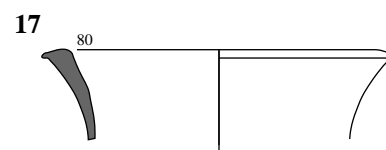
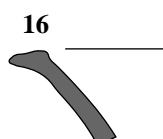
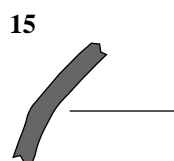
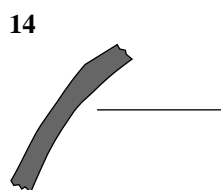
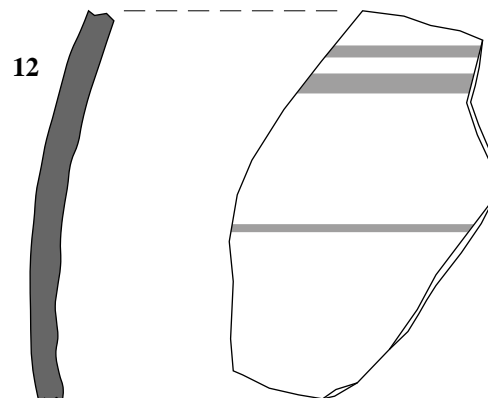
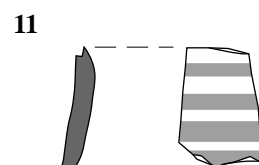
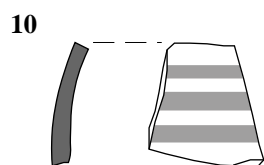
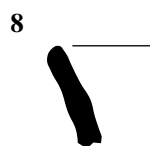

Làm. 79: Ceràmica ibèrica a torn, fenícia i a mà dels jaciments de Castellons 1 [2] (Riba-roja), Barranc de Mosselló [10] (Flix), i Barranc d'en Fabra [129] (Amposta).

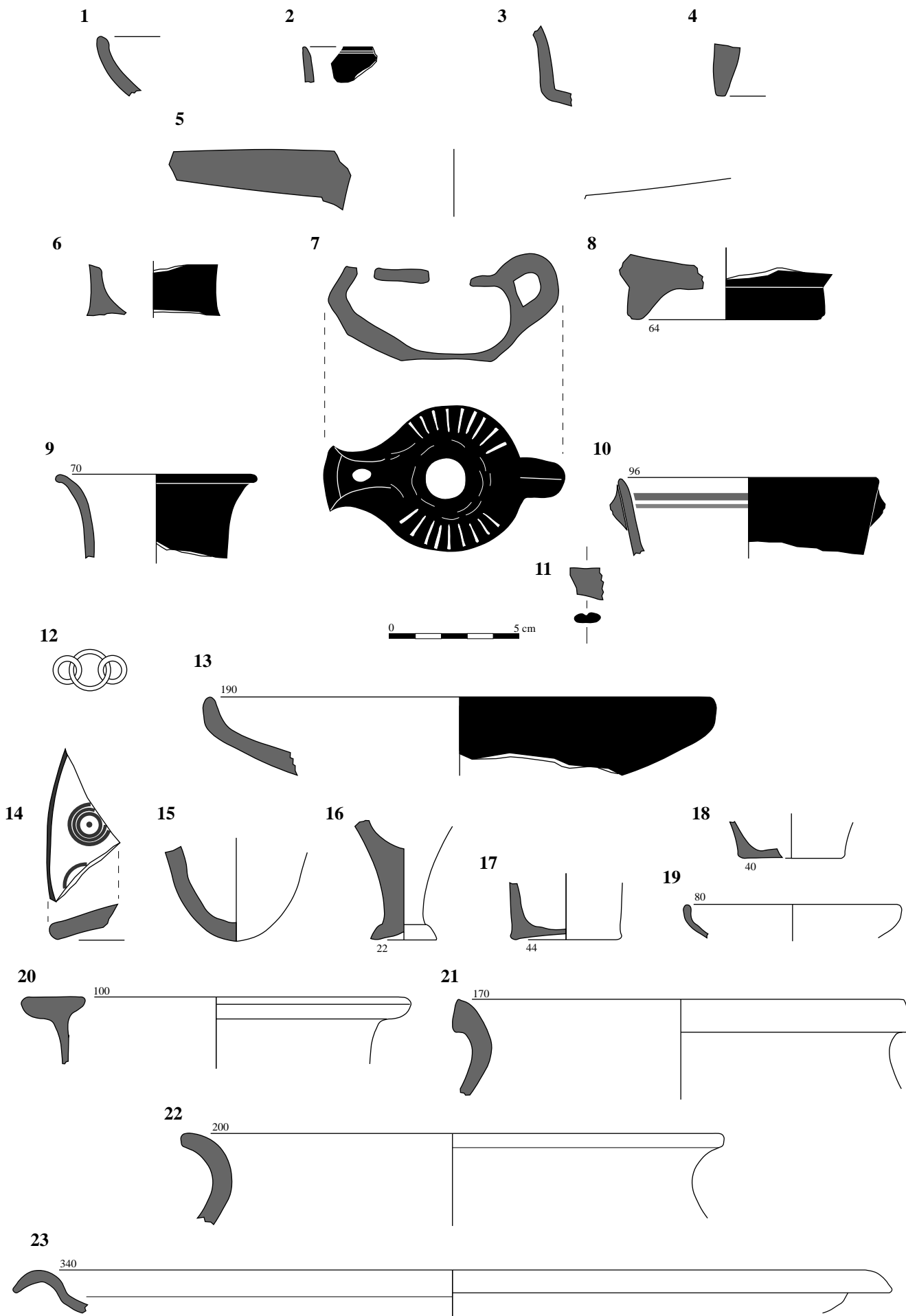

Làm. 80: Materials ceràmics procedents del jaciment de Mas de Mussols [137] (l'Aldea).

1



2



3

2 cm



2 cm

Làm. 81: 1. Boc de pedra localitzat a les rodalies de Tortosa (Gimeno 1974).  
 2-3. Figures antropomorfes de terra cuita de la Serra de l'Espasa [39] (Capçanes).

Sant Miquel de Vinebre

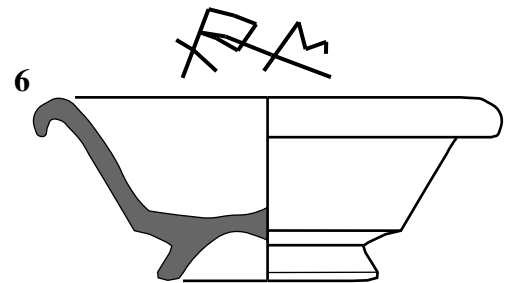
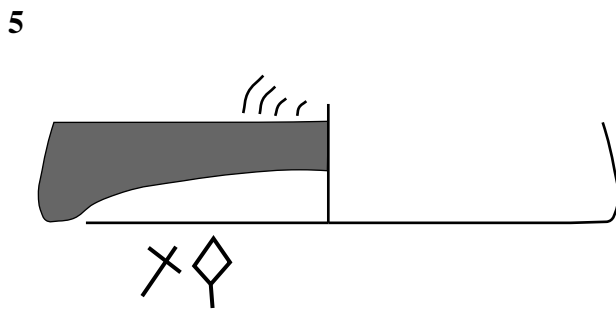
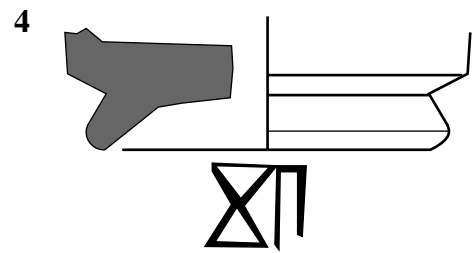
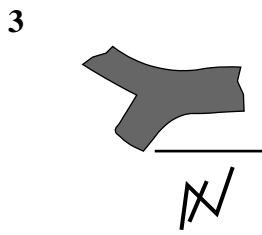
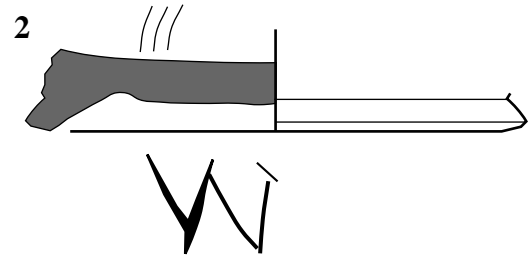
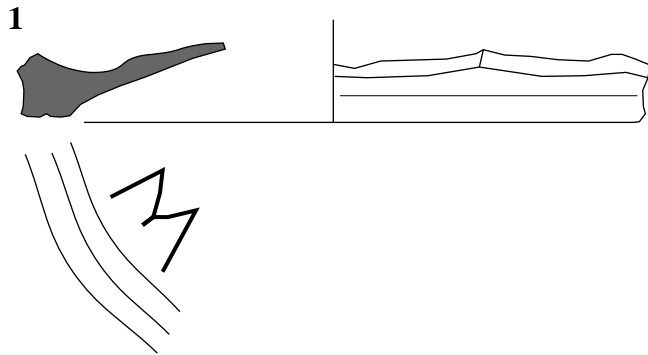

Castell d'Amposta

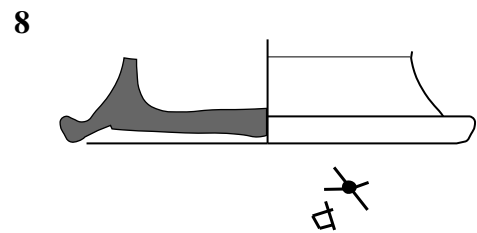
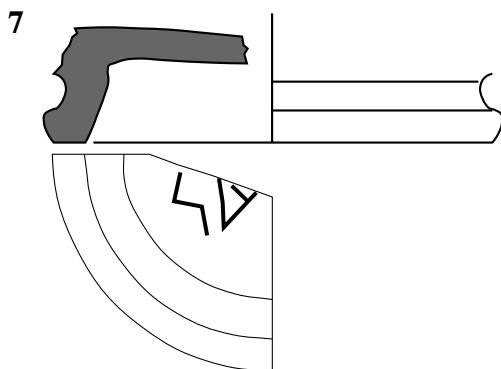

Vila de Marçà



[M(odii)] XIV S (extarii) XXX[...]

Vall de Porcs (Riba-roja)



Làm. 82: Epigrafia tardoibèrica: **Sant Miquel de Vinebre**. 1 i 3. Sanz 1979; 2 i 4. Sanmartí 1978; 5-6. Untermann 1990, 138-139. **Castell d'Amposta**. 7-8. Panosa 1993, 217-218. Epigrafia llatina: **Vil·la de Marçà**. 9. Inèdit. **Vall de Porcs** (Riba-roja), 10. Berni, Carreras, Revilla 1998.

1

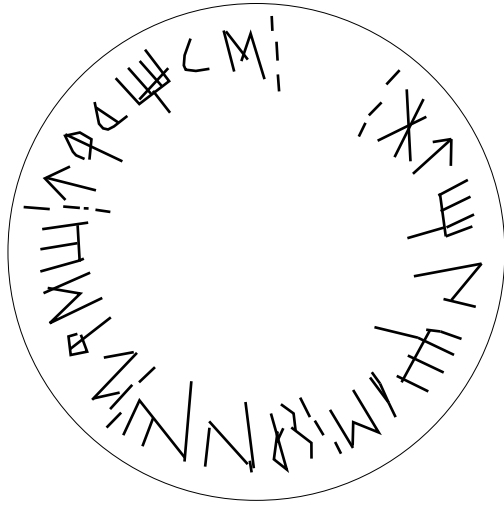

2

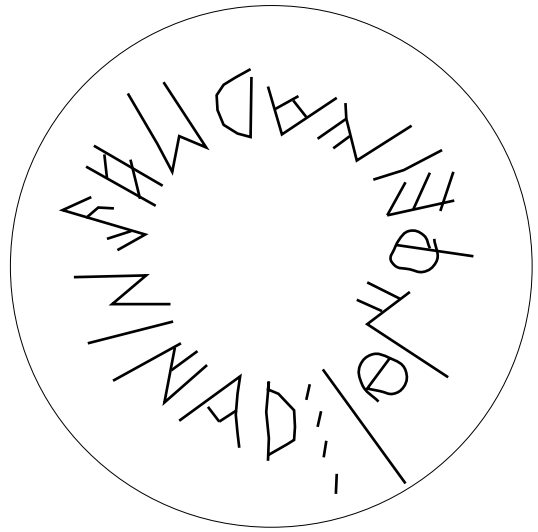

3

↑ N Ψ I M ◊ ↓

4

ININ

5

YN

6

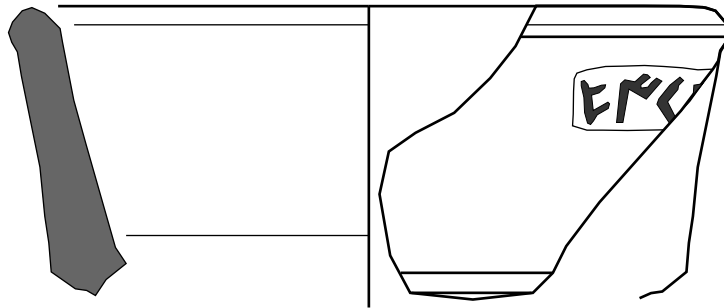

7

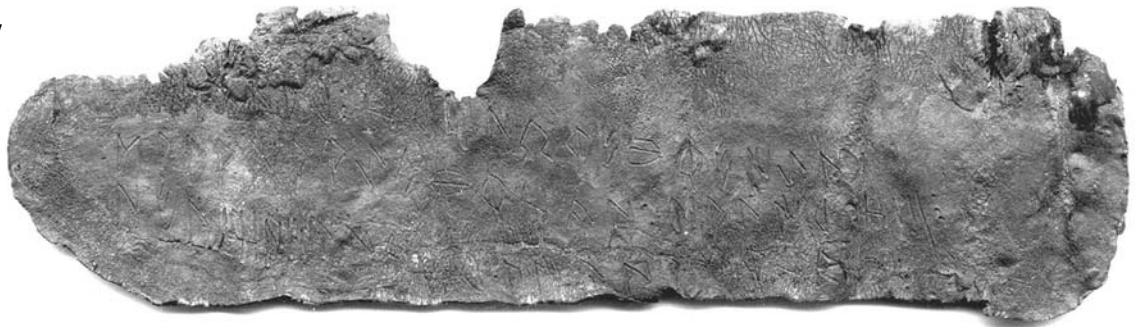

0 5 cm



Làm. 83: Epigrafia ibèrica del Castellet de Banyoles (Tivissa). 1 - 2: Untermann 1990, 129-130; 3 -5: Raddatz 1969; 6: Aguarod 1992, 111. 7: Asensio et alii 2003, 200.

Fragment



Anvers

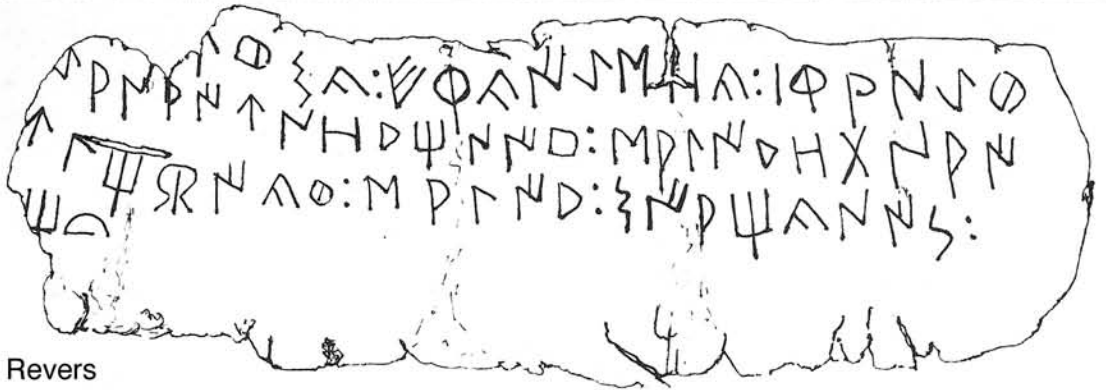

Revers

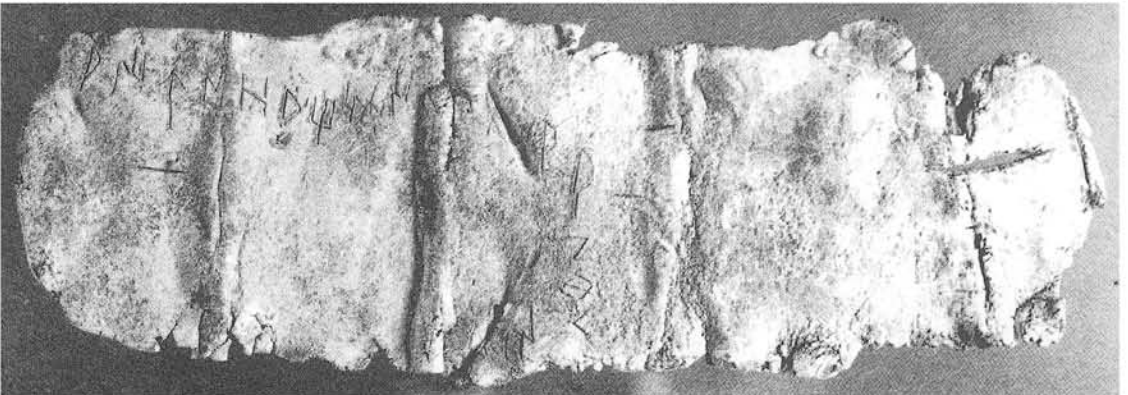

Làm. 84: Epigrafia ibèrica sobre plom, suposadament del Castellet de Banyoles [51] (Tivissa). (Benages 1990-91).